

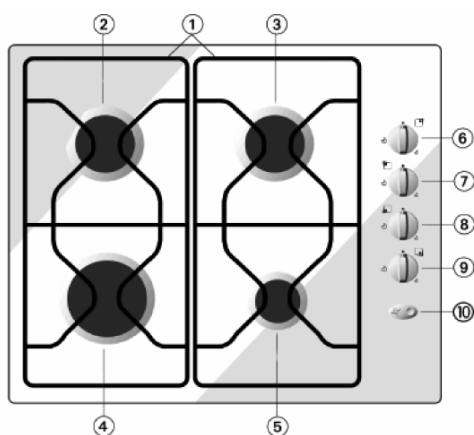



(Apply the label from warranty here)



1. Removable panstand grids
- 2-3. Semirapid burners
- 4-5. Rapid-auxiliary burners
- 6-9. Control knobs
10. Electric ignition button (if present)

Symbols

| | | |
|---------------|---|-------------------------------------|
| Shaded circle | ● | Tap closed |
| Large flame | ☹ | Maximum opening/delivery |
| Small flame | ☺ | Minimum opening or reduced delivery |
| Star | ☆ | Electric ignition |

The symbols    are indicating which cooking field this knob activates

Note: Your cooktop aesthetics can be slightly different from the drawing.

HOW TO USE THE COOKTOP

- To ignite one of the burners, turn the relative knob anti-clockwise to the maximum flame setting
- Press the knob against the control panel to ignite the burner
(if your model is equipped with ignition button - You must press it while turning the knob).
- After the burner has ignited, keep the knob pressed for about 5-10 seconds to allow proper device operation. This burner safety device shuts off the gas supply to the burner if the flame goes out accidentally (because of sudden draught, an interruption in the gas delivery, boiling over of liquids, etc.).
- **The knob must not be pressed for more than 15 sec. If, after that time has elapsed, the burner does not remain lit, wait at least one minute before trying to light it again.**
Note: Should particular local conditions of the delivered gas make the ignition of burner difficult, it is advisable to repeat the operation with the knob turned to small flame setting.
- **The burner might go out when the knob is released.** This means that the safety device has not warmed up enough. In this case, repeat the operations described above. Safety device is optional - if Your model is not equipped with it, the ignition should be instant.
- If Your model is equipped with cast iron electric hotplate You can easy operate it with relevant knob. By turning the knob from position 1 to 6 You can increase the temperature. Switch off the hotplate by turning knob to 0.

PRATICAL ADVICE FOR USING THE BURNERS

For better burner performance, please stick to the following rules:

- Use pots and pans that fit the burners (see table on the right).
- Only use flat-bottomed pots and pans.
- Use the correct amount of water for cooking foods and keep the pot covered.

| Burner | Pot Ø |
|-----------|------------------|
| rapid | from 24 to 26 cm |
| semirapid | from 16 to 22 cm |
| auxiliary | from 8 to 14 cm |

CARE AND MAINTENANCE

To maintain your hob in perfect conditions, clean it after every use, removing any food spills.

 **Disconnect power before servicing or cleaning and wait for it to cool down.**

CLEANING THE HOB SURFACE

- All the enamelled and glass parts should be cleaned with warm water and neutral solution.
- Stainless steel surfaces may be stained by calcareous water or aggressive detergents if left in contact for too long. Any food spills (water, sauce, coffee, etc.) should be wiped away before they dry. Clean with warm water and neutral detergent, and then dry with a soft cloth or chamois. Remove baked-on dirt with specific cleaners for stainless steel surfaces.
Note: Clean stainless steel only with soft cloth or sponge.
- Do not use abrasive or corrosive products, chlorine-based cleaners or pan scourers.
- Do not use steam cleaning appliances.
- Do not use flammable products.
- Do not leave acid or alkaline substances, such as vinegar, mustard, salt, sugar or lemon juice on the hob.

CLEANING THE HOB PARTS

- Grids, burner caps and burners can be removed to be cleaned.
- Clean them by hand with warm water and non-abrasive detergent, removing any food residues and checking that none of the burner openings is clogged.
- Rinse and dry
- Refit burners and burner caps correctly in the respective housings.
- When replacing the grids, make sure that the panstand area is aligned with the burner and that the burner feet are fitted in the respective housings on the hob surface. In the case of single grids, make sure that they fit on the burner cap protuberance.
- Models equipped with electrical ignition plugs and safety device require thorough cleaning of the plug end in order to ensure correct operation. Check these items frequently, and if necessary, clean them with a damp cloth. Any baked-on food should be removed with a toothpick or needle.
Note: to avoid damaging the electric ignition device, do not use it when the burners are not in their housing.

GENERAL ADVICE AND SAFETY INSTRUCTIONS

To get full satisfaction from your hob, please read and save these instructions.

- These instructions are only valid for those Countries where the destination abbreviations are mentioned on the product description sheet and on the hob.
- **Keep the packaging material (plastic bags, polystyrene parts, etc.) out of the reach of children, as they are potentially dangerous.**
- Check whether the hob has been damaged during transport and remove any protective film from the appliance parts.
- **This hob (Class 3) is designed solely for household use for cooking food. Any other use (such as heating rooms) is to be considered improper and, as a consequence, dangerous.**
- **Ensure that the installation and gas/electrical connections are performed by a qualified technician in compliance with current local safety regulations.**
- **This appliance must only be installed and used in well-ventilated rooms, in accordance with current regulations. Read instructions before installing and using this appliance.**
- **Gas adjustment and supply pressure are indicated on the rating plate located under the hob. If the appliance is arranged for a type of gas different from that available, refer to the paragraph "Adjustment to different types of gas".**

NOTES:

- Improper use of the grids can result in damage to the hob surface. Do not position the grids upside down or drag them across the hob.
- If the hob has a glass ceramic top, do not use:
 - Cast iron griddles or terracotta pots and pans
 - Heat diffusers (e.g. metallic mesh)
 - Two cookers for the same pot
- In case of prolonged use, additional ventilation may be needed (opening a window or increasing the extraction force of the hood).
- This appliance is not intended for use by people (including children) with reduced physical, sensory or mental capabilities or lack of experience and knowledge unless they have been given initial supervision or instruction concerning use of the appliance by a person responsible for their safety.
- Keep children away from the hob when it is in use and do not let them play with the controls or any other appliance parts.

 **Warning:** the protective rubber feet on the grids could represent a choking hazard for young children. After removing the grids, please ensure that all the feet are correctly fitted.

Warning: the glass lid (if provided) may shatter if overheated. Before closing it, be sure that all the burners are off.

After use, make sure that the knobs are in position OFF and close the main gas delivery or cylinder tap

PROTECTING THE ENVIRONMENT

1. Packaging

The packaging material is entirely recyclable, and is marked with the recycling symbol , which identifies it as a type of material that must be sent to local waste-disposal centres.

2. Product

This appliance is marked according to the European directive 2002/96/EC on Waste Electrical and Electronic Equipment (WEEE). By ensuring this product is disposed of correctly, you will help prevent potential negative consequences for the environment and human health, which could otherwise be caused by inappropriate waste handling of this product.

The symbol  on the product, or on the documents accompanying the product, indicates that this appliance may not be treated as household waste. Instead it shall be handed over to the applicable collection point for the recycling of electrical and electronic equipment.

Disposal must be carried out in accordance with local environmental regulations for waste disposal.

For more detailed information about treatment, recovery and recycling of this product, please contact your local city office, your household waste disposal service or the shop where you purchased the product.

3. Declaration of conformity

- This hob has been designed, constructed and marketed in compliance with:
 - safety requirements of EEC Directive “Gas” 90/396
 - safety objectives of the “Low Voltage” Directive 2006/95/CE (which replaces 73/23/CEE and subsequent amendments);
 - protection requirements of EEC Directive “EMC” 89/336
 - requirements of EEC Directive 93/68
- This cooktop is suitable for contact with foodstuffs and complies with EEC (CE) Regulation n. 1935/2004.

TROUBLESHOOTING GUIDE

If the hob will not operate correctly. Before calling the After-Sales Service, refer to the Troubleshooting Guide to determine the problem.

1. The burner fails to ignite or the flame is not even

Check that:

- The gas or electrical supplies are not shut off and especially that the gas supply tap is open.
- The gas cylinder (liquid gas) is not empty.
- The burner openings are not clogged.
- The plug end is not dirty.
- All the burner parts have been positioned correctly.
- There are no draughts near the hob.

2. The burner does not stay lit

Check that:

- When lighting the burner, the knob has been pressed for enough time to activate the protection device.
- The burner openings are not clogged near the thermocouple.
- The end of the safety device is not dirty.
- The minimum gas setting is correct (see relevant paragraph).

3. The containers are not stable

Check that:

- The bottom of the container is perfectly flat
- The container is centered on the burner.
- The grids have not been exchanged or positioned incorrectly.

If after the above checks the fault still occurs, get in touch with the nearest After Sales Service.

AFTER-SALES SERVICE

Before calling the After-Sales Service, make sure you can give the following information:

- type of fault or problem;
- exact model (written on the Instruction and Warranty);
- service number that follows the word SERVICE on the rating plate under the hob and on the Warranty;
- your complete address and phone number.

If any repairs are required, please contact **an authorised After-Sales Service**, as indicated in the warranty.

Note: Failure to comply with these instructions may compromise the safety and quality of the product.

SERVICE 0000 000 00000



REFERENCE TO LOCAL REGULATIONS

Provision for ventilation

The room in which the appliance is installed must have an air supply to current **B.S. 5440 - Part 2** standards.

All rooms require a permanent vent in addition to the openable window.

If there are other fuel burning appliances in the same room **B.S. 5440 - Part 2** should be consulted to determine the air vent requirements.

If the appliance is installed in a cellar or basement, it is advisable to provide an air vent of 65 cm, irrespective of the room volume.

INSTALLATION

TECHNICAL INFORMATION FOR THE INSTALLER

- This product can be embedded in a worktop 20 to 40 mm thick.
- If there is no oven beneath the hob, insert a separator panel that has a surface at least equal to the opening in the work surface. This panel must be positioned at a maximum distance of 150 mm below the upper surface of the work surface but, in no case less than 20 mm from the bottom of the hob. In the case that you intend to install an oven beneath the hob, make sure that it is manufactured by Whirlpool and equipped with a cooling system. The manufacturer declines all liability if another brand oven is installed beneath the hob.
- Before installation, make sure that:
 - the local gas delivery conditions (nature and pressure) are compatible with the settings of the hob (see the rating plate and injector table).
 - The outer surfaces of the furniture or appliances adjacent to the hob are heat resistant according to local regulations.
 - Combustion products are discharged outdoors through specific hoods or wall and/or window mounted electrical fans.
 - Continuous natural air circulation is ensured through a clear opening in a wall of at least 100 cm². This wall opening must be:
 - a) permanent and in a wall to the outside of the room to be vented;
 - b) made in such a way that it cannot be obstructed from the inside or outside (not even accidentally);
 - c) protected by plastic grids, metallic mesh, etc., taking care not to reduce the air vent effective area mentioned above;
 - d) located near floor level and positioned so as not to interfere with the operation of the exhaust system.

GAS CONNECTION

- The gas supply system must comply with local regulations.
- You can find specific local regulations for some countries in the paragraph "Reference to Local Regulations". If no information concerning your Country is given, please ask details to your Installer.
- The connection of the hob to the gas pipe network or gas cylinder must be made by means of a rigid copper or steel pipe with fittings complying with local regulations, or by means of a continuous-surface stainless steel hose complying with local regulations. The maximum length of the hose is 2 linear metres.
- Before connecting the tube to the elbow fitting (A), interpose the washer (B) supplied, in compliance with EN 549.

For Belgium - replace the elbow connection with the one supplied in the kit.

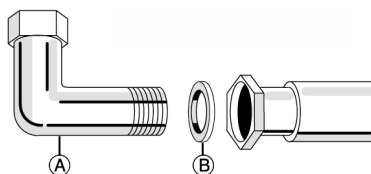

Attention: if a stainless steel hose is used, it must be installed so as not to touch any mobile part of the furniture. It must pass through an area where there are no obstructions and where it is possible to inspect it on all its length.

- After connection to the gas supply, check for leaks with soapy water.

ELECTRICAL CONNECTION

- The electrical connections must comply with local regulations.
- The data relevant to the voltage and power absorption are indicated on the rating plate.
- The earthing of this appliance is compulsory by law.

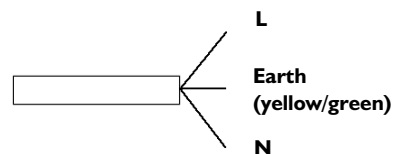

- The manufacturer cannot be held responsible for any injury to persons or animals or damage to property arising from failure to comply with these requirements.
- When the hob is installed, provide a multi-pole circuit breaker with a contact separation of at least 3 mm, that provides full disconnection.
- If necessary, the electrical power cable must be replaced exclusively with a power cable having identical characteristics to the original supplied by the manufacturer (type H05V2V2-F T90°C or H05RR-F). This operation must be performed by a qualified electrician.

ASSEMBLY

After having cleaned the perimeter surface, apply the supplied gasket to the hob as shown in the figure.



Position the hob in the worktop opening made respecting the dimensions indicated in the Instruction.

Note: the power supply cable must be long enough to permit its upward extraction.

1. Fit the brackets into the relevant bores and fasten them by means of their screws.
2. Make an opening in the worktop, respecting the dimensions indicated in the Instruction.
3. Install the cooktop in the worktop.

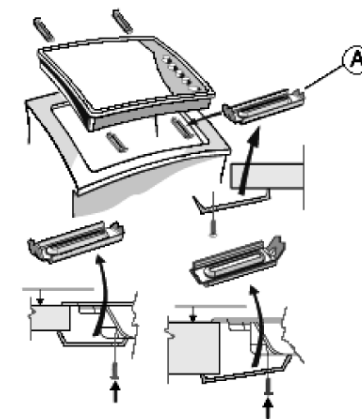

ADJUSTMENT TO DIFFERENT TYPES OF GAS

If the appliance is intended to operate with a different gas from the gas type stated on the rating plate and orange sticker applied on the top of the hob, change the injectors.

Remove the orange sticker and keep it with the instructions booklet.

Use pressure regulators suitable for the gas pressure indicated in the Instruction.

- The gas nozzles must be changed by After Sales Service or a qualified technician.
- Nozzles not supplied with the appliance must be ordered from After Sales Service.
- Adjust the minimum setting of the taps.

Note: when liquid petroleum gas is used (G30/G31), the minimum gas setting screw must be tightened as far as it will go.

Should you experience difficulty in turning the burners knobs, please contact the After Sales Service for the replacement of the burner tap if found to be faulty.

REPLACING THE INJECTORS (see the injector table in the Instruction)

- Remove grids (A)
- Extract burners (B)
- Using a socket spanner of the appropriate size unscrew the injector (C), unscrew the injector to be replaced.
- Replace it with the injector suitable for the new type of gas.
- Re-assemble the injector in (D).
- If you have a Triple Crown burner use side spanner to replace the injector (E)

Before installing the hob, remember to affix the gas calibration plate supplied with the injectors in such a way that it covers the existing information relating to gas calibration.

