

Ceramic Touch Control Hob

LAM1741

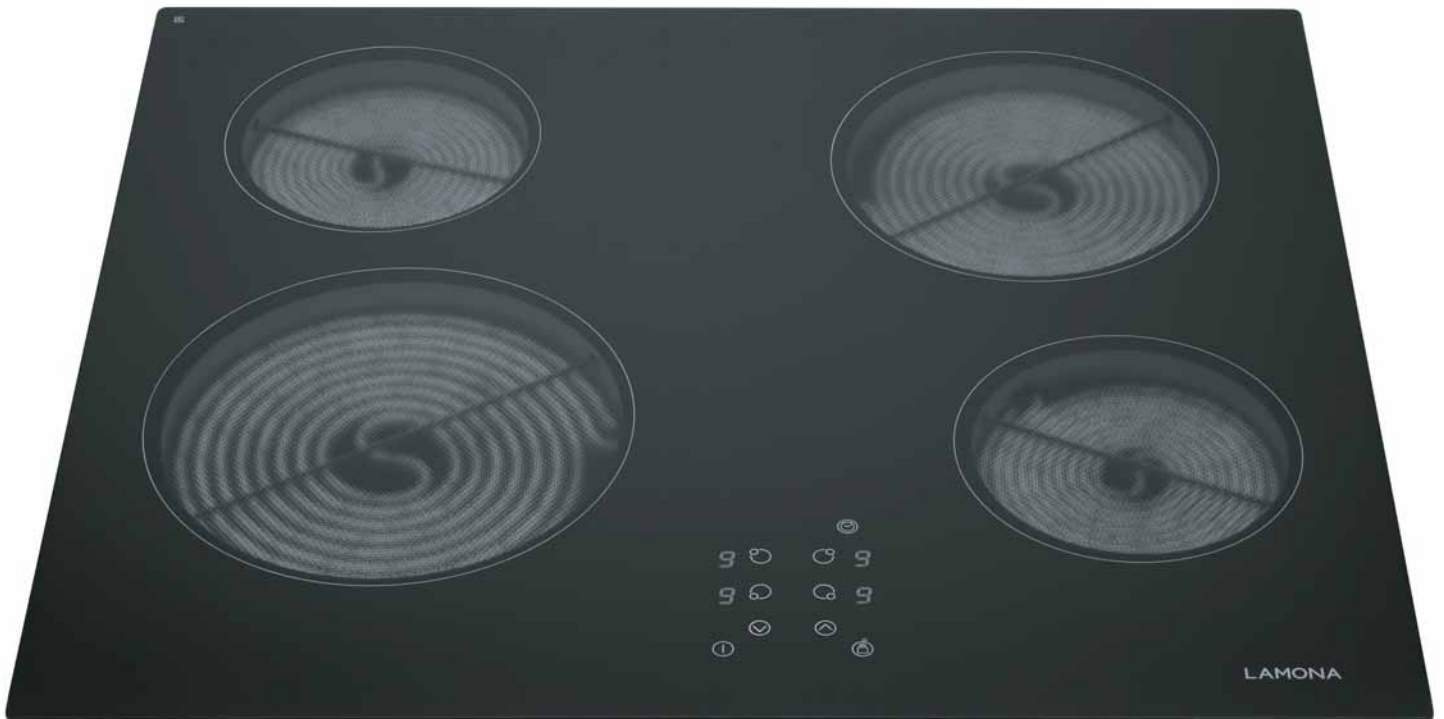

User & Installation Guide

LAMONA
Exclusive to Howdens Joinery Co.

Dear Customer,
Congratulations on your choice of hob which has been designed to give you excellent service.

The user manual will help you use your product quickly and safely.

-
- Please read this user manual before installing and using the hob.
- Always follow the safety instructions.
- Keep this user manual within easy reach for future reference.
- Please read any other documents supplied with the product.

Remember that this user manual may also be applicable for other models and there may be some minor differences between the illustrations and your product.

Explanation of symbols

Throughout this user manual the following symbols are used:



Important information or useful tips about usage.



Warning for possible hazards to health and property



Warning possibility of electric shock.



This product's packaging material is recyclable. Help recycle it and protect the environment by dropping it off in the municipal receptacles provided for this purpose. Your product also contains a great amount of recyclable material. It is marked with this label to indicate the used appliances that should not be mixed with other waste. This way, the appliance recycling organised by your manufacturer will be done under the best possible conditions, in compliance with European Directive 2002/96/EC on Waste Electrical and Electronic Equipment. Contact your town hall or your retailer for the used appliance collection points closest to your home. We thank you for doing your part to protect the environment.

Index

01 - Before Using the hob	04
02 - Safety	04
General	05
Fire safety advice	06
Fire Safety	06
If a pan catches fire	06
Deep fat frying	06
If you have an Electrical Fire	06
03 - Using your hob	08
Touch controls	08
Controls layout	08
Initial setup	08
Functions	09
Timed cooking	10
Safety shut off	10
04 - Cleaning and Maintenance	11
Ceramic hob glass	11
05 - Trouble Shooting	12
06 - Installation	13
General Information	13
Positioning	13
Connect to the electricity supply	16
Technical Data	17
07 - Your guarantee	18

01 - Before using the hob

- Make sure that you have removed all packaging, wrappings, stickers and films from the hob surface.
- It is recommended that you clean and wash the hob surface before using for the first time.
- Apply a thin coat of ceramic hob cleaner to the hob to help maintain and protect it.

02 - Safety



WARNING! - The appliance and its accessible parts become hot during use. Care should be taken to avoid touching heating elements. Children less than 8 years of age shall be kept away unless continuously supervised. This appliance can be used by children aged from 8 years and above and persons with reduced physical sensory or mental capabilities or lack of experience and knowledge if they have been given supervision or instruction concerning the use of the appliance in a safe way and

understand the hazards involved. Children shall not play with the appliance. Cleaning and user maintenance shall not be made by children without supervision.



WARNING! - Unattended cooking on a hob with fat or oil can be dangerous and may result in fire. NEVER try to extinguish a fire with water, but switch off the appliance and then cover the flame with a lid or damp cloth.



WARNING! - Metallic objects such as knives, forks, spoons and lids

should not be placed on the hob surface since they can get hot.



WARNING! -Danger of fire: do not store items on the cooking surface.



WARNING! -Never leave any cook zone on without a pan covering it. This causes a fire hazard.



WARNING! -If the surface is cracked, broken or shattered, switch off the appliance to avoid the possibility of electric shock and call for a service engineer's visit



WARNING! - Servicing should be carried out only by authorised personnel.



WARNING! -

Do not spray aerosols in the vicinity of this appliance while it is in operation.



WARNING! - Do not store or use flammable liquids or items in the vicinity of this appliance.



WARNING! -

Do not modify this appliance.

General

- **Always** ensure that pan bases are dry, stable and flat before using them on the hob.
- **Always** match the size of pan to the cook zone – do not use large pans on small zones or vice versa.
- **Always** position pans over the centre of the cook zone, and turn the handles to a safe position so they cannot be knocked or grabbed.
- **Always** lift pans onto and off the hob, rather than sliding them across the surface, to avoid marks and scratches.
- This appliance should only be used for normal domestic cooking of food.
- **Never** use the hob for any other purpose than cooking food.
- Plastic cooking utensils can melt if they come into contact with a warm hob. Never leave them close to, or on top of the hob.

- **Never** use the hob surface as a chopping board or food preparation area, as this may lead to it becoming damaged.
- **Never** leave aluminium foil on the hob top, it reflects heat back into the element which leads to damage.
- **Never** heat up a sealed tin of food on the hob, as it may explode.
- **Never** leave pans overhanging the edge of the hob. The surface of the hob is smooth. If pans are knocked they may move on the hob top.

Fire safety advice

Most kitchen fires occur when people are distracted or leave things unattended, so remember:

If you're called away from the hob - by the phone or someone at the door, either take pans off the heat, or switch off your hob.

Don't let yourself be distracted while cooking.

If you do have a fire in the kitchen, don't take any risks - get everyone out of your home and call the Fire Service

If a pan catches fire:

- Do not move it as it's likely to be extremely hot.
- Turn off the heat if it's safe to do so, but never lean over a pan to reach the controls.
- Use fire blanket or a damp tea-towel to cover the pan.
- If you have put the fire out, leave the pan to cool completely.

Deep-fat frying presents more dangers in your kitchen

- Never fill a pan (or other deep fat fryer) more than one-third full of oil.
- Do not use a fire extinguisher on a pan of burning oil - the force of the extinguisher can spread the fire and create a fireball.

If you have an electrical fire in the kitchen:

- Pull the plug out, or switch off the power at the fuse box - this may be enough to stop the fire immediately
- Smother the fire with a fire blanket, or use a dry powder or carbon dioxide extinguisher
- Remember: never use water on an electrical or cooking oil fire.

Avoiding damage to the appliance

The ceramic glass of the hob can be damaged by objects falling onto it. Be especially careful with heavy jars of food being stored in cupboards above the hob, we recommend storing them away from the hob area.

The edge of the glass can be damaged by being knocked by cookware. Cookware made of cast iron, cast aluminium or with damaged bottoms can scratch the ceramic glass if pushed across the surface.

Objects that melt and things that boil over can burn onto the ceramic glass and should be removed as soon as possible. To avoid damage to cookware and the ceramic glass, do not allow sauce pans or frying pans to boil dry.

Do not use the cooking zones with empty cookware or without cookware in place.

03 - Using the hob - electric ceramic

Touch Controls

The touch controls for your hob have been designed to provide you with finger tip control of your hob, providing accurate and repeatable power settings for cooking and an easy clean surface that can be easily wiped over. When a cook zone is activated the power setting is displayed for each zone individually,

Controls layout

- a. Referred Zone (x4)
- b. Minute Minder / Fault code
- c. Upper Left Zone
- d. Lower Right Zone
- e. Minus '-' (Power Level / Time)
- f. Power On/off
- g. Timer
- h. Upper Right Zone
- i. Lower Right Zone
- j. Plus '+' (Power Level / Time)
- k. Lock

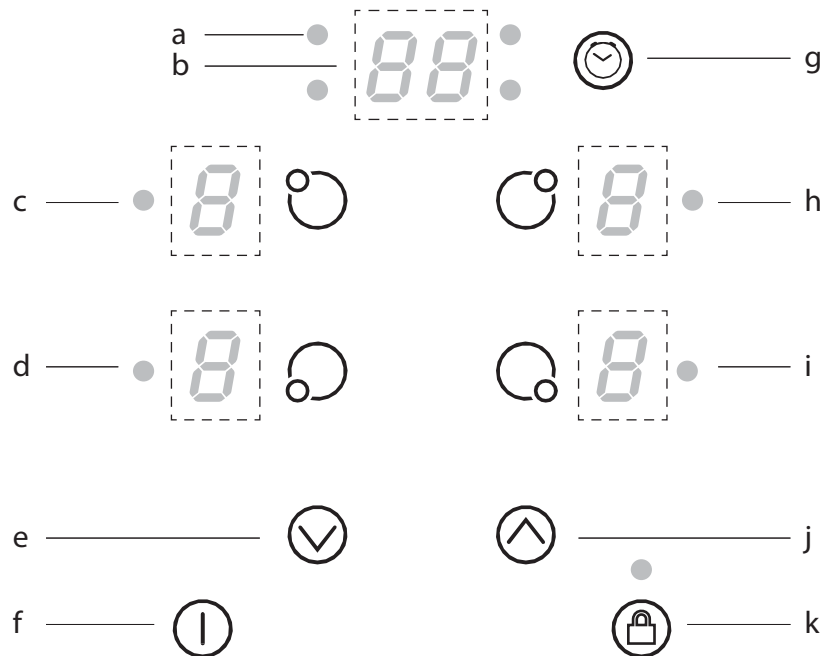

Initial set up

Before switching on the power supply to the appliance, switch off any bright lights (such as cooker hood) and ensure the appliance is not in direct sunlight.

This is to enable the electronic controls to calibrate its sensitivity against natural ambient lighting (approx 30 seconds).

Failure to observe the above will result in the hob not functioning correctly, (Display showing "FL"). To rectify remove all strong lighting sources and re-apply power.

The hob should complete the calibration procedure satisfactorily and lighting such as cooker hoods can be used normally.

Functions

Lock

- A Red Led indicates when the key lock is active, to deactivate/activate, touch the Key Lock key for 1 second.
- The key lock is deactivated when the Red LED switches off.
- If any of the cook zones are ON, the key lock function locks all the keys except the ON/OFF key.
- If the cook zones are OFF, the key lock function locks all the keys, including the ON/OFF key.



The Key Lock is automatically activated every time the electricity supply is switched off and back on to the hob.



To avoid unintentional switching on of the appliance, e.g. by small children and pets, we recommend activation of the key lock feature.

Switching on the hob

- Touch and hold the on/off symbol for 1 sec. The hob will beep and all energy level indicators will display “0”.
- If no other symbol is selected within 10 secs the hob will turn off.

Operating a zone

- Ensure the Key lock is deactivated.
- Touch the On/Off Key for 1 second a beep sounds and the cook zone displays become illuminated.
- Touch the required cook zone key, it will start to flash.
- Whilst flashing adjust the cook zone power level as required by using the Up+/down- keys.
- Then either touch the cook zone key again to confirm the setting or after 5-10 seconds the hob will auto set the hob power and will beep and stop flashing.

- To adjust the power setting follow steps 3-5.
- Repeat as necessary for the other zones.

Switching a zone off

- Touch the required cook zone key until the zone display flashes, now either return the power level to 0 by pressing the down(-) key or simultaneously press the down(-) and up (+) simultaneously and it will jump straight to the 0 setting.

Notes on use

- The power settings on the hob do not indicate any set temperature and cannot be used to judge one element against another.
- During cooking, the elements will cycle on and off. This is normal.

Auto heat-up

- Select appropriate cook zone and increase to power level 9.
- Now press the up (+) key again and until the Red LED is illuminated next to the cook zone.
- The power level will still be flashing, so now select the power level you would like (use the heat up time table for guidance).
- Once set the Red LED is illuminated.
- Once the heat up time as elapsed a beep will sound and the Red Led disappears and the heater remains at the reduced level.

	Power Level	Time (Min/Sec)
Heat up Time (Approx)	1	01:11
	2	02:44
	3	04:47
	4	05:28
	5	06:29
	6	01:11
	7	02:44
	8	02:44

Timed cooking



All 4 cooking zones can be operated under the timer independently and at the same time for up to 99 minutes. When the set time expires the timer will beep and the cook zone will switch off automatically.

To set the timed cooking to a zone:

- Set the desired zone power level as described previously.
- Whilst the cook zone power level is flashing touch the timer key and the timer will illuminate "00" and two Red LEDs will illuminate the first one will be flashing on the timer to indicate the activated timed cook zone and the second one "00." Indicates that the time can be adjusted.
- Using the "+" or "-" symbols, set the time required in minutes.

To check remaining time:

- Touch the symbol for the desired zone followed by the timer symbol.

To adjust the set time:

- Touch the symbol for the desired zone followed by the timer symbol.
- Using the "+" or "-" symbols, reduce or increase the time required (in minutes).

To deactivate timed Cooking:

Touch the symbol for the desired zone followed by the timer symbol.

Adjust the "-" symbol down to "0". At the end of the cooking time

At the end of the cooking time the buzzer will activate and the zone's LED will flash. Touch the zone key to deactivate.

Residual heat indicator

If the glass surface is hot an "H" will be displayed in the cook zone display until the glass has sufficiently cooled.



"H" and "0" will flash alternatively if the cook zone is hot and another cook zone is in use.

lock:

- When the system is in child lock the controls are deactivated. To lock and unlock the hob touch and hold the key symbol.

Safety shut off

- If the power level of a zone is not changed for a long period of time the cook zone will automatically switch off. The maximum time a cook zone can stay on depends on the power level.

Power Level	Max. time on (hrs)
1	10
2	5
3	5
4	4
5	3
6	2
7	2
8	2
9	1

04 - Cleaning & maintenance

Ceramic glass hobs

- It is recommended that you clean and wash the hob surface before using for the first time. Apply a thin coat of ceramic hob cleaner to the hob to help maintain and protect it.
- The ceramic hob top can be cleaned using a clean, damp cloth or kitchen paper. Do not use a used dishcloth or sponge as they can leave a film of detergent on the surface which can lead to discoloration. Please ensure that the elements are cooled fully to avoid steam burns.
- You can use a specialist ceramic cleaner to restore the surface, but use sparingly to avoid coating the hob top too thickly. Too much cream cleaner will lead to discolouration. Use a dry, clean cloth to polish the surface.
- For stubborn marks, a specialist hob scraper or cleaner can be used.
- Do not use steam cleaners or high-pressure cleaning equipment.
- Regular cleaning will prevent any salts or minerals from accumulating on your hob and discolouring the glass.
- Wipe any spillage as soon as possible.
- Clean the hob top as regularly as possible, this will prevent any build up of grease which may be a fire hazard.
- Foods with high sugar content (toffee, fruit juice, jam, etc.) that boil over while cooking, or spattered sugar stains must be immediately removed using a scraper even if hot.

Notes:

- The edge of the ceramic glass will always appear to be a different colour than the top surface due to the ground safety edge.
- Scratches or dark stains on the ceramic glass that cannot be removed do not affect the

function of the appliance.

Safety when Cleaning

- For cleaning, the appliance must be switched off and cooled down.



Risk of burns from residual heat.

05 - Trouble shooting

If you encounter a problem, it is often something minor, please read some of the suggested tips below.

The hob is not working	Check the fuse/circuit breakers to see if you are experiencing a power failure
The hob has turned itself off	Check that the main on/off switch has not been touched or covered accidentally, remove any objects on the hob and try turning it back on again.
Repairs	Repairs are to be carried out by trained service technicians.
Display F and letters	If "F" and letters appear on the display, your unit has detected a fault, the following table lists actions you should take to correct the problems

Error codes

Hob Status Codes	Fault Description	Action
H	Residual Heat	"H" will switch off when glass surface drops below 60oC
Hob Status Codes	Fault Description	Action
F0	Touch Control Error	Switch the power off and on, The system will reset and the hob should now be working correctly
FA	Touch Control Error	Switch the power off and on, The system will reset and the hob should now be working correctly
FU	Touch Control Error	Switch the power off and on, The system will reset and the hob should now be working correctly
FJ	Touch Control Error	Switch the power off and on, The system will reset and the hob should now be working correctly
FC	Touch Control Error	Switch the power off and on, The system will reset and the hob should now be working correctly
Fr	Touch Control Error	Switch the power off and on, The system will reset and the hob should now be working correctly
Fc or F	Overheat / Temperature Problem	Allow hob to cool then Switch the power off and on, The system will reset and the hob should now be working correctly
FE	Overheat / Temperature Problem	Allow hob to cool then Switch the power off and on, The system will reset and the hob should now be working correctly
Ft	Overheat / Temperature Problem	Allow hob to cool then Switch the power off and on, The system will reset and the hob should now be working correctly
FL	Poor Ambient Light Conditions	Switch off lighting in area, Clean hob surface, Switch the power off and on, The system will reset and the hob should now be working correctly

If any of the above problems persist please contact the customer service line for further assistance,

06 - Installation

General information

Installation should only be carried out by a qualified installer or engineer.

Please keep to the following points most carefully;

Although every care has been taken to ensure this appliance has no burrs, or sharp edges, we recommend that you wear protective gloves when installing and moving this appliance. This will prevent injury.

The minimum distances to other appliances and units are to be observed.

Wall surfaces above the work surface and in the immediate vicinity of the cooking hob must be heat resistant.

Laminated surfaces and the adhesive used for fixing them must be heat resistant in order to avoid any damage.

The space for air circulation, located underneath and at the back of the hob improves its reliability by ensuring that it will cool down, efficiently.

Installations should be carried out in line with the National Regulations applicable with this product type.

Note: Avoid installing the appliance next to doors and under windows. This will avoid the potential for hot cookware being knocked off the hob when doors and windows are opened (Risk of burns).

Built-in appliances may only be used after they have been built-into suitable built-in units and surfaces that meet the required standards.

Positioning

Choosing your installation

We recommend that you install this appliance in a work top which is a minimum 38mm deep.

The hob can be fitted into a work top less than 38mm deep, but the 25mm gap between hob base and appliance must be maintained.

Installing the hob over a unit with a drawer or door

- The base of the appliance must be protected from damage e.g. draws may only be installed providing a partition panel is fitted maintaining the 25mm gap underneath the appliance.

Installation above an oven

- Refer to the manufacturer's instructions for clearances above the oven. We recommend a minimum 25mm gap between the bottom of the hob and appliance

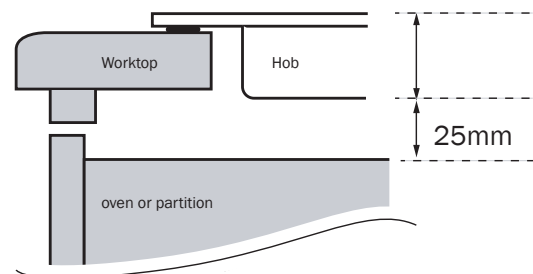

Clearances and dimensions – requirements

- No shelf or overhang of combustible material should be closer than 650mm above the hob.
- There must be a minimum clearance of 50mm between the edges of the hob and any side walls; this clearance must be maintained up to 420mm above the worktop.

- When installing an extractor hood above the hob, refer to its manufacturer's instructions Clearances and dimensions – requirements
- There must be a minimum clearance of 50mm between the rear edge of the hob and the rear wall. This clearance must be maintained up to 650mm above the worktop (unless otherwise stated in your extractor manual)

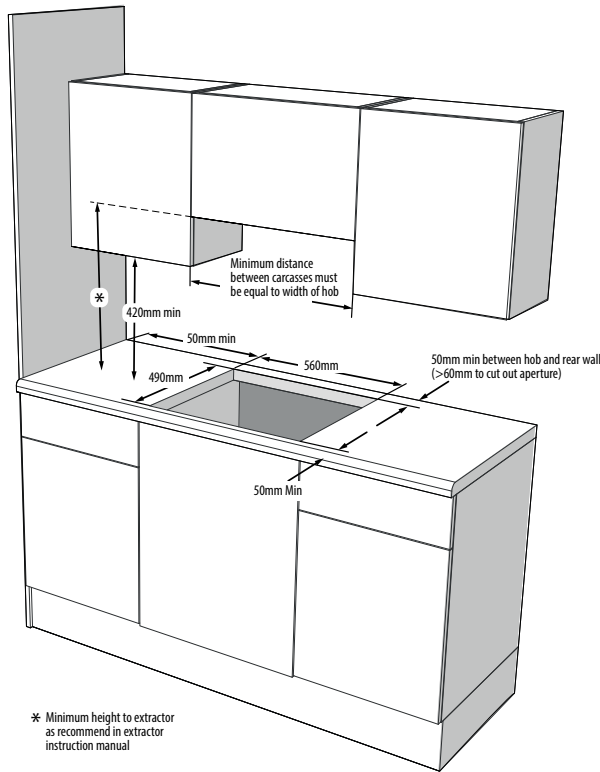

Fitting into worktop

Cut a hole in the work surface to the required size. (560mm x 490mm) as illustrated above.

A clearance of at least 50mm should be maintained between the cutout and any rear or side wall.

The worktop must be of heat-resistant material or covered with heat-resistant material.

Protecting the cut-out

The types of chipboard used for work surfaces swell relatively quickly in contact with humidity.

Apply a suitable sealant to the cut edge to protect it from moisture ingress.

Self Adhesive Seal

Apply the self adhesive seal to the underside edges of the hob glass. For best results, the seal should be adhered along each side in turn, as close to the edge as possible, and trimmed at each corner, taking care to ensure a neat join.

This hob can be installed conventionally (glass above the work top) or recessed into the work top for a flush fit.

Conventional Installation

Install the 4 spire clips shown in fig.1A.

Place the hob in the aperture, checking the hob glass is covering the work top along all four sides.

Set the front edge of the appliance parallel with the front of the work top.

Locate and attach the securing clamps as required, Tighten the screws so that the hob is pulled down firmly against the worktop, thus ensuring a good seal.

Recessed method

Recess the work top to the appropriate depth (Approx 5mm) and shape to fit the hob (add 1mm to overall glass size).

Install the 4 spire clips shown in fig.1A.

Insert the hob into the recess, ensuring that the foam seal is sitting correctly.

Locate and attach the securing clamps to the front and rear underside of the hob, using the screws provided. Tighten the screws so that the hob is pulled down firmly against the worktop, thus ensuring a good seal.

You may want to fill any gap between the hob top glass and the work top surface with silicone sealant.



DO NOT fit silicone sealant under the glass hob instead of foam seal.

CONVENTIONAL INSTALLATION

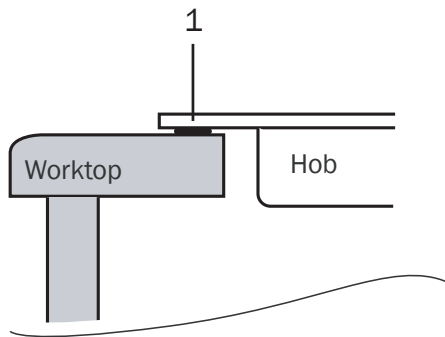

- 1. Self adhesive seal

RECESSED METHOD

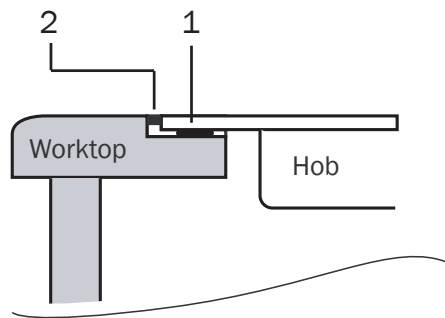

- 1. Self adhesive seal
- 2. Silicone sealant

Fixing brackets



Installation advice :

Depending on the cabinets, the worktop thickness and the hob positioning, it is possible for the hob base and/or the clamp brackets to interfere with parts of the cabinet.

If necessary cut away cabinetry and use appropriate fixing brackets for your installation

Underside of hob
Typical Installation positions

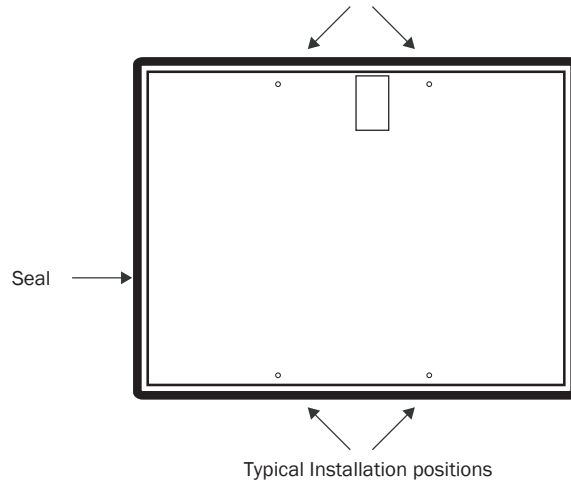

Secure the hob to the worktop by means of the brackets provided, taking the thickness of the worktop into account.

fig.1A.

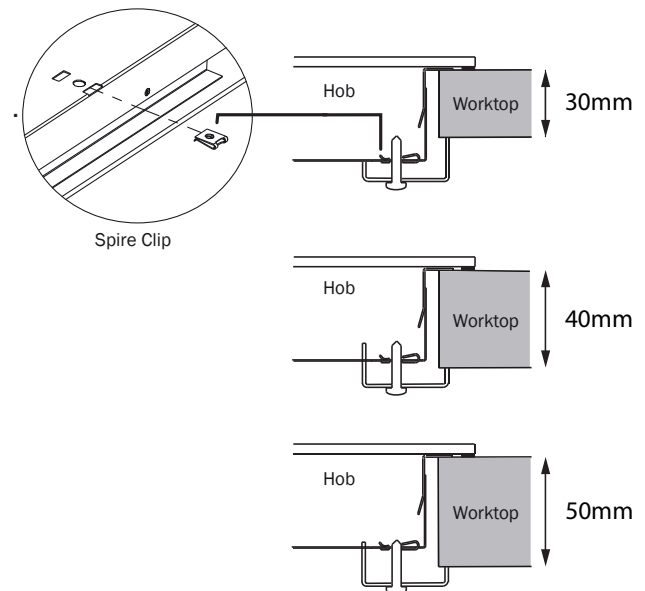

Connect to the electricity Supply



This appliance must be earthed. Only connect to the electrical mains terminal with the power switched off. The electrical mains terminal is live.

Follow the terminal block connection schematic.

Loose and inappropriate connections can make the terminal overheat.

Ensure the cable clamp is fitted correctly and securely.

A device must be provided in the electrical installation which allows the appliance to be disconnected from the mains at all poles with a contact opening of at least 3mm.

We recommend that the appliance is connected by a competent person who is a member of a “Competent Person Scheme” who will comply with the required local regulations.

Connection should be made with a suitable cable.



Ensure that you route all mains electrical cables well away from any adjacent heat source, such as an oven or grill.

Firstly open the terminal block cover using a small flat bladed screwdriver in the door release tabs shown.

Strip the wires & connect to the terminal block as shown in the terminal block schematic.

Fit the cable clamp & secure with the screw provided.

Close the terminal box, ensuring that the cover is closed and all screws are tight and in place.

Note; The cable clamp has a ratchet type mechanism on the right hand side of the retaining arm.

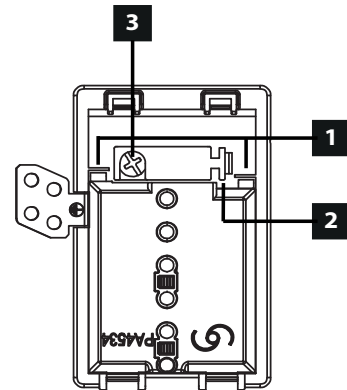

- 1** Door release tab
- 2** Cable clamp ratchet
- 3** Cable clamp screw

Terminal Block Connection Schematic

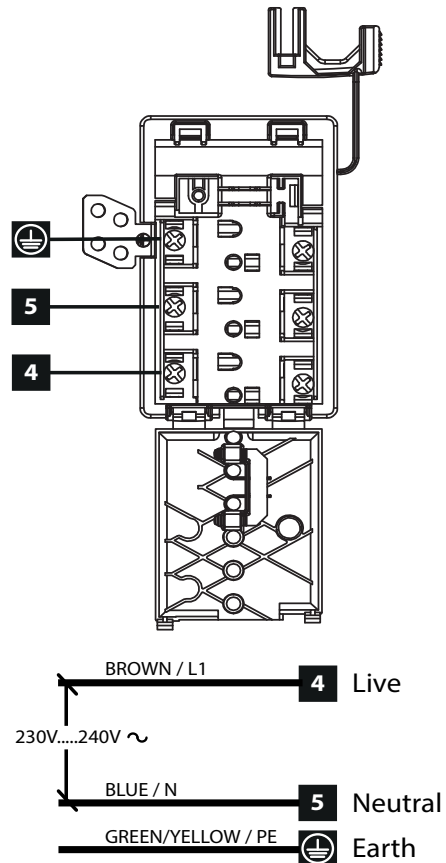

Technical data

Technical Data	
Electrical Supply	220~240V 50Hz
Total Power Rating @ 220 - 240V ~ 50Hz (kW)	5.8 kW
Hob Details	
Cook Zone	Normal Power Rating kW
LH Front	2.1
LH Rear	1.2
RH Rear	1.8
RH Front	1.2
Hob Dimensions (W X D X H) mm	590 x 520
Cut Out Required (W x D) mm	560 x 490
Cable Type	HORR-F5 4.0mm ² , 3 core or equivalent

This appliance conforms to European Directive 2009/125/EC regarding Eco design requirements for energy-related products

07 - Your guarantee

Product Guarantee Details (UK only)

Your appliance has the benefit of a comprehensive manufacturer's guarantee which covers the cost of breakdown repairs. (Details of which are shown on your Proof of Purchase Document).

- Any claim during the period of the guarantee (MUST BE ACCOMPANIED BY THE PROOF OF PURCHASE)
- The product must be correctly installed and operated in accordance with the manufacturer's instructions and used for normal domestic purposes.
- This guarantee does not cover accidental damage, misuse or alternations which are likely to affect the product.
- The guarantee is invalid if the product is tampered with, or repaired by any unauthorised person.

(The guarantee in no way affects your statutory or legal rights)

What to do if you need to report a problem-

Please ensure you have ready:

- **The product's model & serial numbers**
- **Howdens Proof of Purchase document**
- **Your full contact details**



Call the Service Line on 0845 00 60 006

Product Information

Commission Regulation (EU) No 66/2014

LAMONA

Model	LAM1741
Type of hob	Ceramic
No of cooking zones	4
Heating technology ∅	Ceramic FL - 220mm RL - 150mm FR - 150mm RR - 190mm
EC _{electric cooking}	FL - 158 Wh/kg RL - 184 Wh/kg FR - 215.5 Wh/kg RR - 216.5 Wh/kg
EC _{electric hob}	193.5 Wh/kg

 If supplied, please stick your self adhesive product rating plate here, or make a note of the product serial number below in the box below for future reference.

Serial Number :

w

This file was downloaded from the site
mans.io

Instruction manuals and user guides

[Samsung](#)

[Pioneer](#)

[Alpine](#)

[LG](#)

[Dell](#)

[Sharp](#)

[Sony](#)

[Philips](#)

[Epson](#)

[Netgear](#)