Dishwasher

LAM8603



User Guide

LAMONA
Exclusive to Howdens Joinery Co.

Welcome

Dear Customer

Congratulations on your choice of a quality dishwasher which has been designed to give you excellent service.

Please read these instructions before installing the dishwasher and using it for the first time. The information contained herein is provided to avoid accidental risks and/or damage to your appliance

Make sure you understand the controls prior to using your appliance. The dishwasher must only be used for its intended purpose, i.e. the washing of dishes in the home. Failure to observe these instructions may invalidate your right to free service during the guarantee period.

Please keep these instructions in a safe place for your future reference

If you have any questions, or if you are not sure about any information contained in this booklet please contact us - details are on the back cover.

Note

Due to the quality control processes during production, there may be some water left in your machine. This does not cause any damage.

Preparation before use

It is recommended that the dishwasher is operated on the Eco programme with prewash before loading with dishes.

Electrical Safety

The dishwasher should only be operated on the voltage specified. For electrical safety, only earthed plugs and sockets should be used. Always use the fused plug provided with the appliance. The user is responsible for meeting these basic safety requirements. The life of your machine and your safety depend on you using an electrical installation compliant to standards.

Do not use an extension cable.

When disconnecting your machine from the mains supply, always pull from the plug. Never pull the cord itself.

Children's Safety

Never allow your children to play with your dishwasher.

Dishwasher detergents contain irritants and abrasives. These ingredients might have caustic effects in the eyes, mouth and throat.

They can be extremely dangerous if swallowed. Avoid contact with skin and eyes. Check that the detergent receptacle is empty after completion of the wash cycle.

Keep detergents out of children's reach and do not put detergent in the machine until right before you start the washing programme.

The water in your dishwasher is not suitable for drinking, for this reason do not allow your children near your machine when the front door is open.

Never allow your children to play on or sit on the front door when the front door is open.

After unpacking your machine, keep the packing material out of children's reach.

Warning !

Long cutlery, such as ladles and long knives, etc must be placed horizontally on top of the full cutlery basket or on the racks to prevent accidental injury.

General

This dishwasher has been designed to clean your dirty dishes at home.

Never use chemical solvents in your machine; this may lead to explosion risk.

Never use materials other than specially produced softening salts in the salt dispenser of your machine.

Never use materials other than specially produced detergents and rinse-aids in the detergent and rinse aid dispensers of your machine.

Please dispose of the packaging material and old appliances carefully. Please ensure old machines do not become a threat to child safety. It is known that children lock themselves in unused machines. To avoid such a problem it is advised that you cut the mains cable off and break the door latch so it does not lock.

The door of your machine is designed to support the weight of a full basket when the lower basket is pulled all the way out. Never place any other load on the door, otherwise the machine may be damaged.

After using the dishwasher always close the door as an open door can be a hazard.

Do not open the door whilst the appliance is in operation.

Recycling

Please help us to protect our environment. Packing materials and some parts of your machine are produced using recyclable materials. These materials are marked up with recycling symbol and material type information (>PE<, >PS<, >POM< ...). These raw materials should not be mixed with general refuse and should be given to recycling centres. We suggest you contact your local authority for disposal information and facilities available.

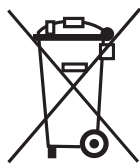

This product bears the selective sorting symbol for waste electrical and electronic equipment (WEEE).

This means that this product must be handled pursuant to European Directive 2002/96/EC in order to be recycled or dismantled to minimize its impact on the environment. For further information, please contact your local or regional authorities.

Electronic products not included in the selective sorting process are potentially dangerous for the environment and

human health due to the presence of hazardous substances.

Energy and water saving

Scrape excess food from the dishes before loading. Start your dishwasher after fully loading the machine. Do not use the pre-wash programme unless required. Make your programme selection as per the programme chart and quick reference guide supplied.

What should not be washed in your dishwasher

Do not wash items soiled with cigarette ash, candle/paint wax, dyes, chemicals etc. since these may damage your machine



Do not wash forks, knives and spoons with wooden or bone handles, items stuck together with adhesives, plastic items not resistant to high temperatures. Copper, tin items and aluminium ware in your dishwasher.



As with hand washing, some “on-glaze” decorated china, aluminum or silver have a tendency to discolour or fade. Also, certain types of glassware and crystals may lose their shine and become opaque in time.

A chemical reaction can occur between silver cutlery and stainless steel cutlery. As a precaution, do not wash together.

Iron and cast iron objects can rust and stain other items.

Pay special attention to whether or not the item you wash in the dishwasher is dishwasher-proof.

If in doubt, contact the manufacturer of the item.

Do not overload your dishwasher or do not load items other than those mentioned in this manual.

TABLE OF CONTENTS

Warning and safety information 2

Electrical Safety	2
Children's Safety	2
General	2
Recycling	3
Energy and water saving	3
What should not be washed in your dishwasher	3

Know your dishwasher 6

Specification	6
---------------	---

Programme Chart 7

Before first use 8

Electrical requirements	8
Warning	8
This appliance must be earthed	8
Important	9
Fitting a different plug	9

How to use 10

Water hardness & regeneration settings	10
Water Hardness Level Adjustment Table	11
Adding Dishwasher Salt	12
Detergent use	12
Filling detergent dispenser	14
Rinse aid	15
Loading the dishwasher	16
Movable Cutlery Basket	17

Operating the dishwasher 18

Hot Air Drying	18
----------------	----

How to clean your machine 19

Upper spray arm	20
Lower spray arm	20

Before calling service / Trouble shooting 21

Guarantee 23

2 Know your dishwasher

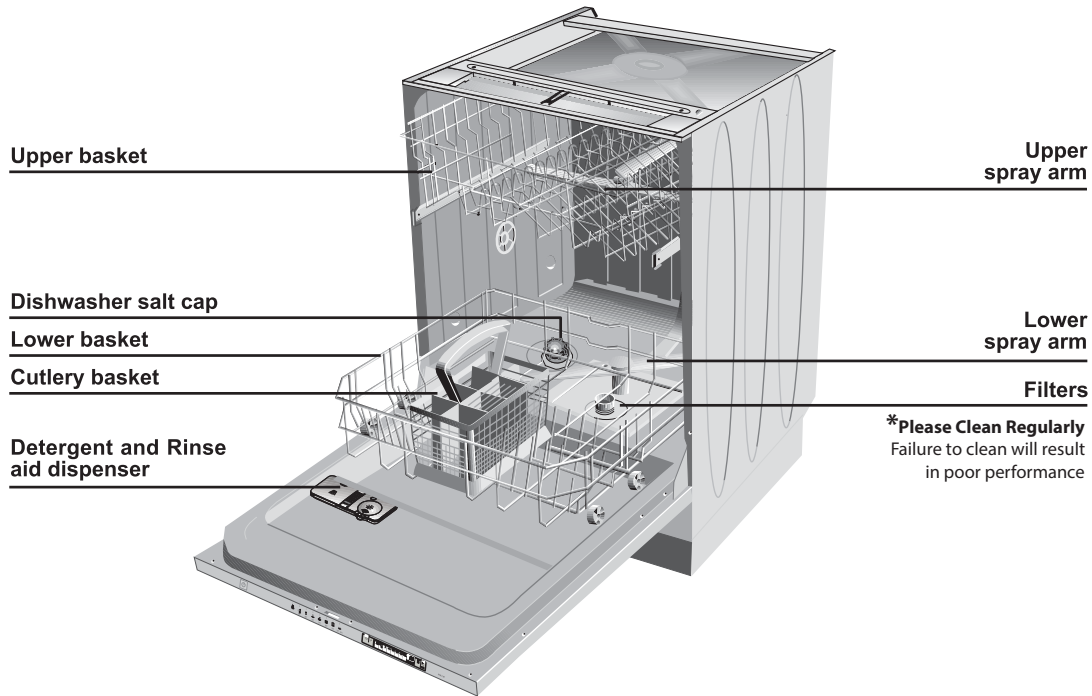

Specification

Load Capacity	: 12 Place settings
Height	: 820 mm
Width	: 598 mm
Depth	: 550 mm
Net weight	: 32 kg
Supply voltage	: 220-240 V ~ 50 Hz
Fuse current	: 13 A
Total power	: 1900-2200 W
Heater power	: 2000 W
Pump powers	: 90/30 W

Because we continually strive to improve our products, we may change our specifications and designs without prior notice.

Note for Testing Institutes

The necessary information for performance testing will be provided upon request. The request can be done by e-mail through:

dishwasher@standardloading.com

Please do not forget to write the model code, stock code and serial number information of the appliance besides your contact information in the e-mail.

The model code, stock code and serial number information can be found on the rating label, which is placed on the side of the door.

3 Programme Chart

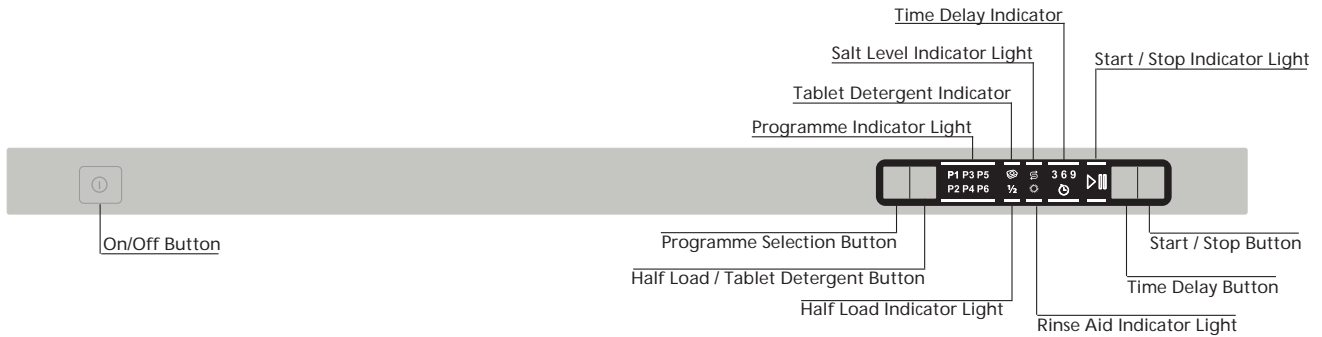

<i>Programmes and temperatures</i>	<i>Cycle Selection Information</i>	<i>Water Consumption (Litres)</i>	<i>Energy Consumption (Kwh)</i>	<i>Running Time (min)</i>
P1 ECO* 50°C	Most economic programme for normally soiled dishes	14	1,02	185
P2 PRE-WASH No Heat	Pre-wash to rinse and loosen food residue awaiting full load - then select a programme	4,2	-	14
P3 RAPID 35°C	Lightly soiled dishes 30 minute programme	11,8	0,79	30
P4 NORMAL 60°C	Normally soiled dishes, A-class cleaning in 58 minutes	11,8	1,32	58
P5 INTENSIVE 70°C	Heavily soiled dishes requiring hot pre-wash	17,5	1,67	115

<i>Plate Size (cm)</i>	
<i>Upper Basket</i>	<i>Lower Basket</i>
20	20

4 Before first use

After unpacking your dishwasher, check the machine for any possible transportation damage. Never install and use damaged machines. If your machine is damaged contact your supplier. Always have your machine installed by qualified electrician/plumber to ensure correct installation.

Any repairs and maintenance work on this dishwasher should be carried out by authorised service staff only. Unauthorised repairs are not only dangerous, but also lead to the cancellation of your guarantee.

Make sure the electricity and water connections of your dishwasher are in compliance with the instructions for installation as stated in the relevant part of this booklet.

It is recommended that the dishwasher is operated on the Economy programme with prewash before loading with dishes.

Before the first wash, **add 1 Litre of water to the salt container of your machine.**

Electrical requirements

Before you insert the plug into the wall socket make sure that the voltage and the frequency shown in the rating label corresponds to your electricity supply.

We recommend that this appliance be connected to the mains supply via a suitable switched and fused socket in a readily accessible position.

If the supply cord or the mains lead is damaged please do not replace it yourself. The supply cord or the mains lead must be replaced by a Lamona Authorized Service Agent or a similarly qualified person.

Warning

This appliance must be earthed

If the fitted moulded plug is not suitable for your socket, then the plug should be cut off and an appropriate plug fitted.

Destroy the old plug, which is cut off as a plug with a bared cord could cause a shock hazard if inserted into a socket elsewhere in the house.

The moulded plug on this appliance incorporates a 13A fuse. Should the fuse need to be replaced an ASTA approved BS1362 fuse of the same rating must be used. Do not forget to refit the fuse cover. In the event of losing the fuse cover, the plug must not be used until a replacement fuse cover has been fitted.

Important

Fitting a different plug

As the colours of the wires in the mains lead of this appliance may not correspond with the coloured markings identifying the terminals on your plug, proceed as follows:

1. Connect the green - yellow or green (earth) wire to the terminal in the plug marked 'E' or with the symbol  or coloured green and yellow or green.
2. Connect the blue (neutral) wire to the terminal in the plug marked 'N' or coloured black.
3. Connect the brown (live) wire to the terminal in the plug marked 'L' or coloured red.

With the alternative plugs a 13A fuse must be fitted either in the plug or adaptor or in the main fuse box. If in doubt contact a qualified electrician.

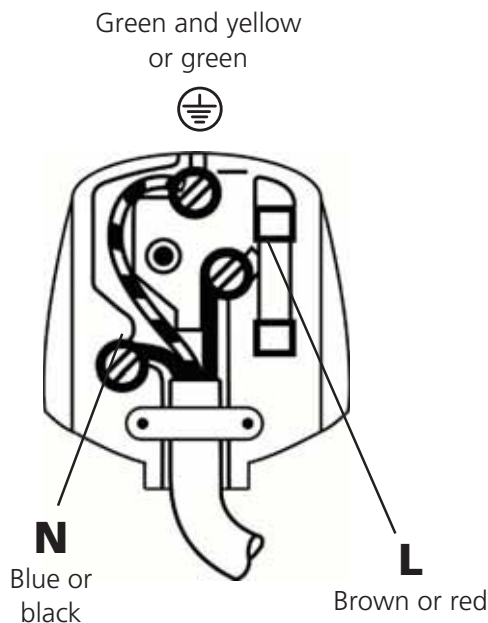

5 How to use



Water hardness & regeneration settings

The dishwasher requires lime free water. Hard water leaves watermarks on your dishes. Your dishwasher has a special water softening system to remove the hardness of the tap water. Setting this system correctly will increase the washing effectiveness.





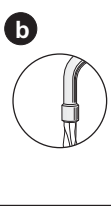

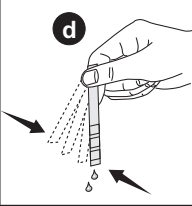
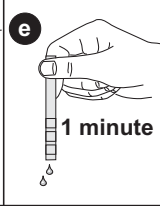
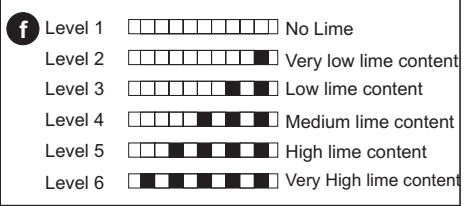
To find out the hardness level of water in your area, contact your local Water Board or determine water hardness level by the help of test strip provided.

If you move to a different location, the level of water hardness will possibly be different. It is essential to reset the water hardness in order to obtain optimum washing efficiency.

Test Strip

					
Remove the test strip from its packing.	Let the water flow from your tap for 1 minute.	Fill a glass with tap water and dip the test strip into water for 1 second.	Take the test strip out of the water and shake it.	Hold for 1 minute.	Set the water hardness level of your dishwasher according to the result shown by the test strip.

Water Hardness Level Adjustment Table

Hardness Level	English Water Hardness °dE	German Water Hardness °dH	French Water Hardness °dF*	Water Hardness Level Indicator
1 st Level 	0-5	0-4	0-8	Press the Programme Selection button to set the water hardness level to P1 position.
2 nd Level 	6-9	5-7	9-13	
3 rd Level 	10-15	8-12	14-22	Press the Programme Selection button to set the water hardness level to P2 position.
4 th Level 	16-19	13-15	23-27	Press the Programme Selection button to set the water hardness level to P3 position.
5 th Level 	20-24	16-19	28-34	Press the Programme Selection button to set the water hardness level to P4 position.
6 th Level 	25-62	20-50	35-90	Press the Programme Selection button to set the water hardness level to P5 position.

! For level 5 and level 6 there is no difference between hardness level settings.

If the hardness of the water you use is more than 80°dF (French Hardness) or if you are using well water, we recommend that you use filters and purifiers.

* If your tap water is below 9F (French hardness), you do not need to use special dishwasher salt in your machine. In this case, salt indicator light will be on continuously.

- Turn on the machine by pressing On / Off key while pressing and holding the Programme Selection key when the machine is in off position. Press and hold the programme key until the water hardness level stored on your machine is displayed in the program indicator.

Start / Pause indicator will start flashing once the stored water hardness setting is displayed.

- By using Programme Selection key, adjust water hardness level according to the hardness of the supply water. See “Water hardness level adjustment table” for correct setting.
- Select the water hardness level suitable to your machine from the Water Hardness Level Adjustment Table by pressing the Delayed Start Key.
- Press «Start/Pause/Cancel» key for once to store the level you have selected.
- Start / Stop icon will light continuously when the new water hardness level is stored.
- Press the On/Off button to turn off your machine.

Adding Dishwasher Salt

Only use special pelletized dishwasher salt in your machine to soften the hard water. Never use other types of salts including table salt, animal feeding salt, sea salt, culinary salt. These types of salt do not dissolve in water easily and will damage your appliance beyond repair.

When you run the dishwasher, the Water softener will be full of water. **Therefore, adding softening salt should always be done immediately before you start the dishwasher.**

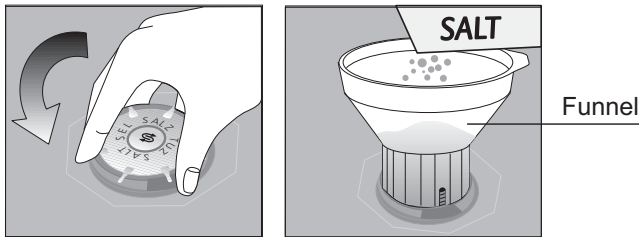

Caution : Only fill with salt just before starting one of the complete washing programmes to prevent any grains of salt causing corrosion. Ensure 1 Litre of water has been added. You can put approximately 2 kg softening salt in the Water softener.

To fill the container with softening salt, remove the lower rack first and unscrew the cap of the water softener turning anti clockwise.

Using the funnel provided will make filling easier.

After you fill the container, screw cap tightly back into place turning clockwise until you hear a click sound.

Detergent use

Any brand of powder, gel and tablet detergents that have been designed for household dishwashers, may be used.

Keep detergents in a cool and dry place and out of the reach of children.

Detergent must be added to the container before each use.

Detergent overdose may cause scratches on your dishes and there may be traces of detergent left in your machine.

Three types of detergent are available

- Phosphate and containing chlorine.
- Phosphate containing no chlorine
- Neither containing phosphate nor chlorine

New compact powders are generally phosphate-free. As phosphates have water softening properties, we suggest you add salt to the salt container even if the hardness of your water is as low as a 6 clarke degrees.

In hard water areas if a phosphate free detergent is used, white marks on the dishes and glasses may be observed. It may be prevented by increasing the amount of detergent.

Detergents without chlorine have less bleaching effect. Coloured stains may not be completely removed. This may be prevented by increasing the amount of detergent, using a programme with a higher wash temperature or using a detergent with chlorine.

Warning!

Two-in-one and three-in-one detergents

You will obtain the best results from your dishwasher if you use separate detergent, rinse aid and water-softening salt.

Detergent manufacturers also produce combined detergents known as 'two-in-one' and 'three-in-one'.

Three-in-one: These products contain detergent, rinse aid and water-softening salt.

Two-in-one: These products contain detergent and either rinse aid or water-softening salt.

In general, you will obtain satisfactory results from combined detergents only under specific usage conditions. These detergents contain predetermined amounts of rinse aid and/or softening salt. This means that you cannot adjust the amount of water-softening salt and rinse aid required to suit the water hardness level in your home.

You should bear the following points in mind when using such detergents:

- Be sure to check the specifications of the product you are using and whether it is a combined product or not.
- Follow the instructions on the packet when using these products.
- The use of these products at the correct appliance settings will ensure economical use of salt and/or rinse aid.
- If the detergent is in tablet form, never place these in the internal section or cutlery basket of the

dishwasher. Always place the tablets in the detergent dispenser of the detergent holder.

Using three-in-one detergent, softening salt and rinse aid.

- These detergents will not give you the same drying performance that you can obtain by using separate detergent, salt and rinse aid. To increase the drying performance:
- Put your appliance's rinse aid setting at "1" and apply rinse aid. When the rinse aid is used up, add more rinse aid to the rinse aid dispenser.
- If you use combined detergents with a rinse aid setting higher than 1, hand contact may leave rainbow-coloured water stains on the washed items and inside the machine.
- If you use combined detergents without adding salt, lime scale may form especially on glasses. To avoid lime scale formation:
- Put your appliance's water softener setting at "1" and add salt. When the salt is used up, add more salt to the water softener.

Using two-in-one detergent: detergent and softening salt

- These detergents do not contain rinse aid so you need to use the rinse aid setting as described in the manual, making sure that there is rinse aid in the rinse aid dispenser with every wash and that you refill the rinse aid dispenser with rinse aid every time it is empty.

Using two-in-one detergent and rinse aid

- These detergents will not give you the same drying performance that you can obtain by using separate detergent, salt and rinse aid. To increase the drying performance:
- Put your appliance's rinse aid setting at "1" and apply rinse aid. When the rinse aid is used up, add more rinse aid to the rinse aid dispenser.
- If you use combined detergents with a rinse aid setting higher than 1, hand contact may leave rainbow-coloured water stains on the washed items and inside the machine.
- These detergents do not contain softening salt so you need to use the softening setting as described in the manual, making sure that there is salt in the water softener with every wash and that you refill the water softener with salt every time it is empty.

Important warning

Should you encounter a problem that has previously never occurred after you start using these detergents, contact the detergent manufacturer directly. You will find contact details on the packet.

If you stop using this kind of detergent:

- Ensure that the salt and rinse aid dispensers are full.
- Put the water hardness setting at the highest level and run a wash cycle with the appliance empty.
- After washing while empty, return the water hardness setting to the correct level for your mains water

hardness shown in the manual.

- Put the rinse aid setting at the correct level.

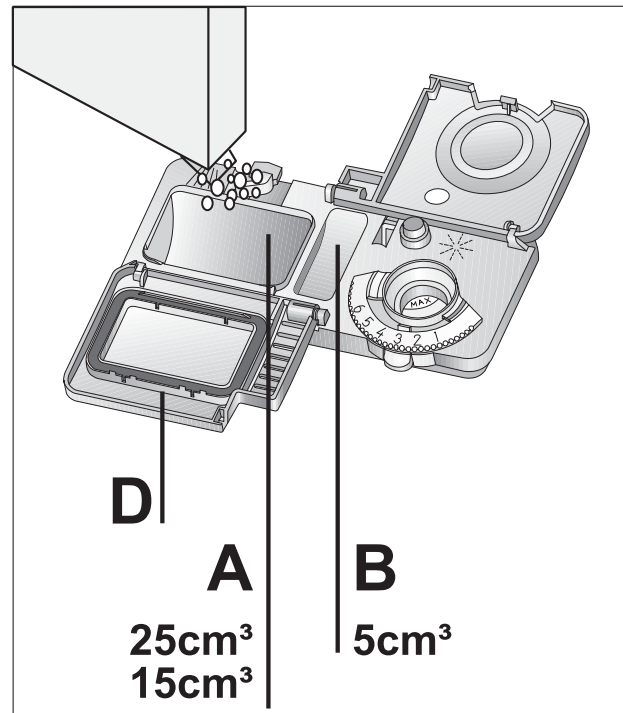

Filling detergent dispenser

If the dishwasher is considerably full and the dishes are relatively dirty, fill the main container (A) up to 25cm³ level. If the dishwasher is not quite full and the dishes are only slightly soiled, fill the main container (A) only up to 15cm³ level.

If your dishes are kept unwashed for a long time and the food particles are stuck on the dishes also fill the small container (B) up to 5cm³. Depending on the degree of soiling and the water hardness in your area it may be necessary to add more detergent.

Powder and gel detergents are poured into the dispenser.

If you are using tablet detergent read the manufacturer's recommendations on the packaging in order to determine

where the tablets should be placed inside the dishwasher (detergent dispenser, cutlery basket, etc.) After you put in the detergent, shut the container lid (D) and ensure you hear the clicking sound.

During the wash programme the detergent will dispense automatically and the lid (D) will remain open when the programme finishes.

Do not use detergent when using the pre-wash programme.

Detergent residues

Regular use of low temperature washes and/or short duration programmes can lead to undissolved detergent residue build up. We recommend to carry out a service wash at the highest temperature possible every 3 - 4 months with the dishwasher empty and without using detergent. It is not recommended to carry it out with auto programme.

Rinse aid

Use only rinse aid intended for household dishwashers.

The rinse aid is specially formulated to be used in the dishwashers for the prevention of watermarks and scale on dishes and to increase the efficiency of the washing and drying processes. Therefore, make sure that there is adequate amount of rinse aid in the rinse aid dispenser of your machine.

You can adjust the amount of rinse aid used during the wash programme by turning the rinse aid dispenser regulator (C).

The dispenser regulator (C) may be set between levels 1 and 6 (6 being the

maximum amount of rinse aid usage). Your machine is pre-set at the factory to level 4.

According to the finish and drying results obtained, adjust the dose of rinse aid by means of the six position selector. (Position 1: minimum dose, Position 6: maximum dose.) Gradually increase the dose if there are drops of water or lime spots on the dishes after washing. Reduce it if there are sticky whitish streaks on the dishes.

Filling the rinse aid dispenser

Open the rinse aid dispenser lid by pressing the button as shown in the diagram.

Fill up with rinse aid until the container is full to level of 'max' mark .

Put the lid (E) on and ensure you hear the clicking sound.

Remember to CLOSE the lid after every refill.

Make sure you clean any rinse aid that you might have spilled.

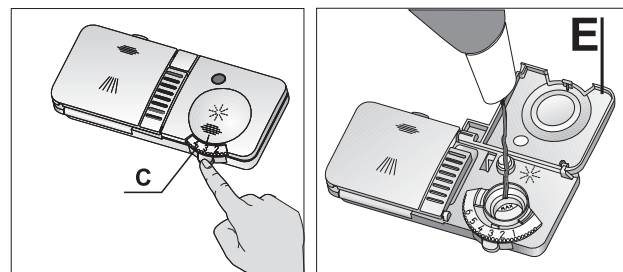

Loading the dishwasher

Loading the dishwasher correctly will increase the washing, drying and energy performance of your machine. Examine the information given in this section and the information stated in the Programme chart and quick reference card given with the manual. Remove any large scraps of food from the dishes before placing in the dishwasher to avoid clogging the filters.

There are three separate baskets, in which you can put your dishes. Place large or heavily soiled items in the lower basket, and small, light or delicate articles in the upper basket. Put forks, small and medium size knives and spoons in the cutlery basket.

Loading the Upper Basket

1. Glasses
2. Saucers
3. Dessert Bowl
4. Cups
5. Tall Glasses
6. Long Utencils

Loading the Lower Basket

7. Pan Lids
8. Side Plates
9. Serving Dish
10. Serving Bowl
11. Cutlery
12. Dessert Bowl
13. Side Plates
14. Pans
15. Dinner Plates
16. Side Plates

Place tall, narrow items in the middle of the racks.

Long-stemmed glasses should lean against the basket, the racks, or the supports not against the dishes.

The shelves on the rack are made height adjustable to accommodate tall items.

When loading your dishwasher please ensure tall glasses (and/or wine glasses) rest against the sides of the upper basket. Do not allow tall glasses to rest against each other since they may be damaged during washing if not properly supported.

Always arrange saucepans, cups and glasses etc. upside down. You can fold the racks in the upper basket when you need more space for larger items.

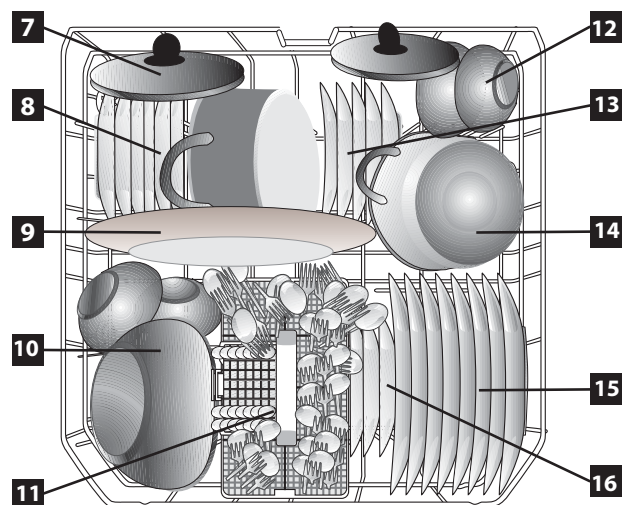
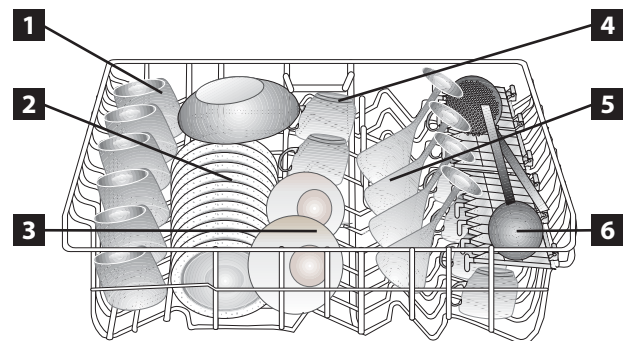

Movable Cutlery Basket

Designed to allow free placement of the dishes according to their size, the movable cutlery basket can slide over the tines to the left (A) and right (B) side.

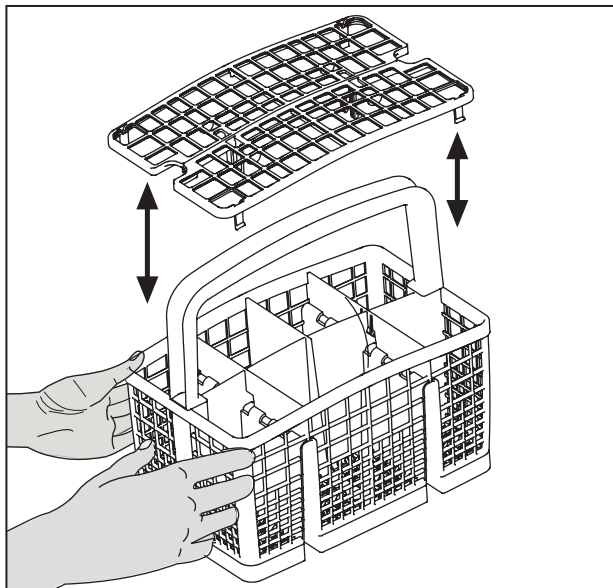
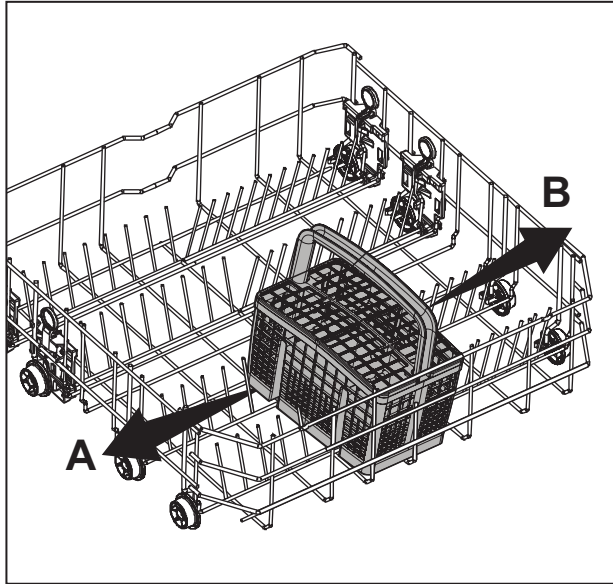

6 Operating the dishwasher

- Turn the water tap on. Open the door of the machine.
 - Check that the upper and lower arms can rotate freely.
 - Add the detergent
 - Push in the on/off button and check that the programme indicator lights come on.
 - Check the salt and rinse aid level indicator lights before you start the machine. If necessary add salt and rinse aid.
 - Select the required programme by referring to the programme chart.
 - Select the desired programme by using the Programme Selection Button. Then select from available options, if required.
 - Press Start/Pause/Cancel button and check that the function indicator light comes on.
 - Close the door then programme starts.
 - An audio signal with an interval of 10 seconds warns you to switch your machine off when the selected washing program ends. This audio signal warns you for a duration of 5 minutes and then turns off.
- Unload the baskets - we recommend to turn off the water tap when not in use

! Just after the dishwasher has started the selected programme, if you find that you want to put in another item to be washed, open the door carefully. Care must be taken if opening the door, as steam and water will escape. Then after putting in the item, close the door. The dishwasher will resume operation.

Hot Air Drying

Hot Air Drying ensures your dishes are dried efficiently.

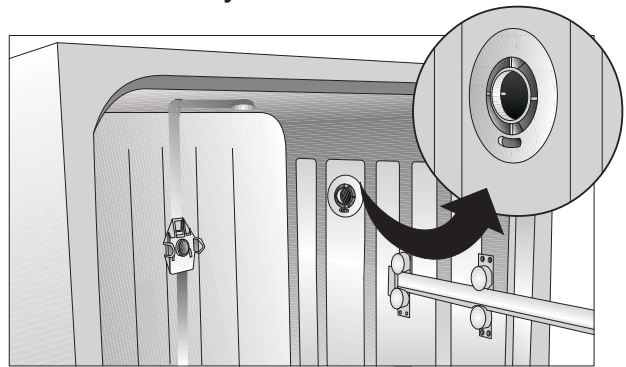

Unloading dishwasher

Dishes should be allowed to cool for about 15 - 30 minutes after the end of the programme.

! Do not open the dishwasher door whilst the appliance is in operation. However, in case the door is opened while the machine is working, then a safety mechanism ensures the machine immediately stops. Water may be very hot, so be careful.

! Care must be taken if opening the door, as steam and water will escape.

- Press the on/off button after the programme is completed. The indicator lights will go off.

You will improve drying results by leaving the dishwasher door ajar for at least 15-30 minutes as soon as the programme finishes.

! Care must be taken when opening the door, as steam will escape.

First unload the lower, then the upper rack. This prevents drops of water from falling onto the full lower basket when the dishes in the upper basket are being removed.

7 How to clean your machine

Cleaning your machine at regular intervals ensures longer product life and reduces the risk of recurring problems. Clean spray arms and in particular filters at least once a week

! Always unplug the appliance and turn off the water supply before cleaning.

To clean the door seal, use a neutral detergent and a damp cloth. To clean the control panel, use only slightly damp cloth.

! Do not use abrasive detergents.

If the appliance is not going to be used for a long period of time, switch off, turn off the water clean and leave the door ajar.

How to clean the filters and spray arms filters
For the efficient operation of your dishwasher, check the filters and the spray arms regularly.

There are three different filters in your machine

Main filter
Coarse filter
Micro filter

To remove the coarse and micro filter assembly to clean, turn it anti clockwise as far as it goes and lift it up. Then press the two tongues inwards and pull out the coarse filter.

Pull the main filter off.

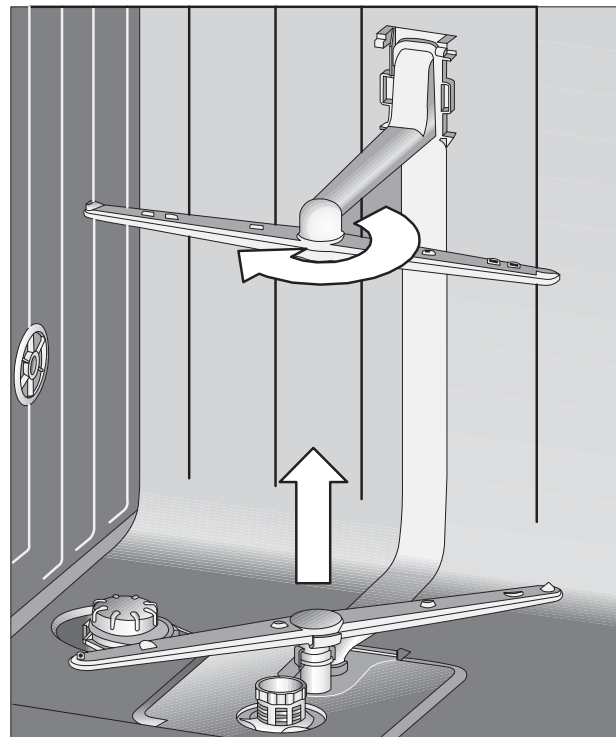
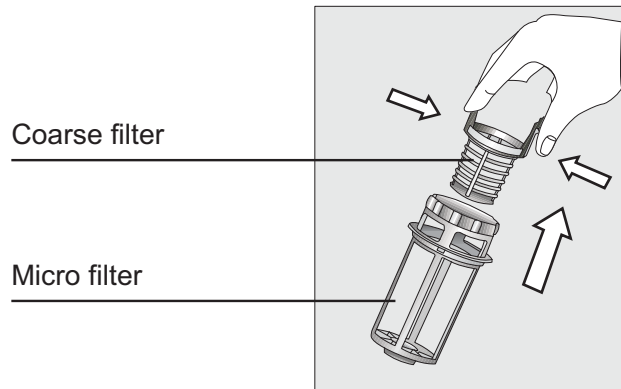
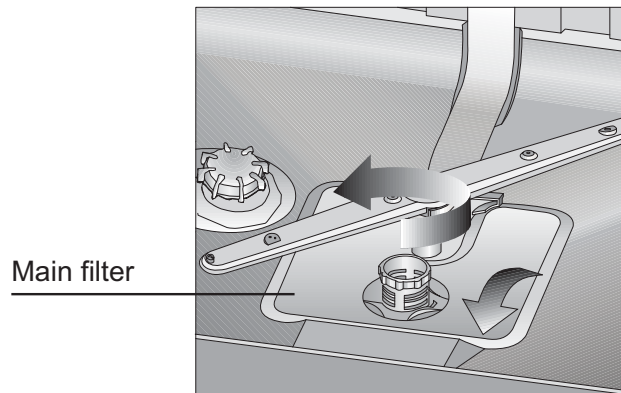

Clean all three filters under running tap water with a brush.

Reinsert the main filter in its place.

Place the coarse filter into the micro filter. Ensure the marks align properly.

Turn the coarse filter clockwise until you hear a clicking sound.

It is important that you fit the filters correctly.

Caution: the dishwasher must not be used without filters.

Incorrect repositioning of the filters will produce poor washing results.

Cleaning of the filters is vital to ensure correct operation of the machine.

Upper spray arm

Turn the nut anti clockwise and remove both the nut and the spray arm.

Flush away food particles under running water.

Put the spray arm back on and screw on the nut turning clockwise until a clicking sound is heard.

Lower spray arm

Remove the spray arm from its slot by releasing the catches and pulling it upwards.

Flush away the food particles under running water.

Reinsert the spray arm back into its original position.

9 Before calling service / Trouble shooting

Before calling service check the following & Trouble shooting guide supplied on the following page.



Is the machine plugged in?



Is the dishwasher door closed firmly?



Does the fuse need replacing ?



Are the filters clogged?



Is the water mains supply fully turned on?



Is the detergent dosage and/or rinse aid sufficient? Is there enough salt in the water softener?



Is the machine switched on?

TROUBLE SHOOTING GUIDE

SYMPTOMS	POSSIBLE CAUSES	SOLUTIONS
Spotting / filming / poor cleaning results	Insufficient amount of detergent	Increase the amount of detergent, especially when washing full loads, or in hard water.
	Hard water.	Increase water softener dosage. Use additional detergent, increase rinse agent dosage.
	Spray arms need cleaning	Check the nozzle holes in the spray arms. They may be blocked with a soil particle. Check and clean them periodically.
	Improper loading.	Follow instructions for use for proper loading procedures. Place dishes so water spray reaches all soiled surfaces. Do not overcrowd the baskets since this will block the water spray.
	Insufficient water fill.	Check mains water pressure
	Filter system needs cleaning.	Remove any accumulated or deposited foods. Check and clean them periodically.
	Oversudsing - Prewashing with a liquid dishwashing detergent.	Rinse items thoroughly before putting them in the dishwasher to remove dishwashing detergent.
Small particles (food or detergent) left on items	Water not reaching surfaces, dishwasher overcrowded.	Check to be sure water action is not blocked by dishes. Check filter system for accumulated or deposited food or detergent. Load dishwasher correctly. Keep filter system clean.
	Insufficient water fill.	Check mains water pressure
	Powder detergent stored too long or under adverse conditions.	Use powder detergent within one to two months after purchase. Open one box at a time. Always close pouring spout after each use. Store in a cool, dry place.
	Rinse aid supply depleted.	Add rinse aid to the dispenser.

Pitting of stainless steel items	Prolonged contact with salty or highly acidic foods or with undissolved or highly concentrated detergent.	Remove spots with silver polish. Rewash. Wash soon after use, or pre-wash items if they will not be washed right away. Do not overload cutlery basket. Avoid spilling or pouring detergent directly on flatware. Make sure dispenser cup is properly closed.
Dishes not dry	Improper loading.	Load so that all items are properly tilted for good drainage. Avoid nesting of dishes and/or silverware.
	Rinse aid supply depleted.	Add liquid rinse aid .
Scratches on glassware	A water or chemical reaction with some glassware. Usually caused by some combination of soft or softened water and alkaline washing solutions reacting with the glassware. Can be accelerated by poor rinsing, overloading and excessive temperature.	The condition may not always be preventable. To minimize the possibility of etching, use minimum amount of detergent.
		Use of the appropriate programme.
		Use of a rinse aid may also help.
Detergent cakes in detergent dispenser.	If using powder detergent, there may be dampness in the dispenser.	Make sure dispenser is dry before adding powder detergent. Start dishwasher immediately.
	If using gel detergent, the detergent may be left in dispenser too long before using.	Start dishwasher soon after adding gel detergent. Do not allow detergent to dry out in dispenser.
	Faulty cover.	Do not overfill. Cover should close tightly. Check cover for fit.
	Improper loading.	Do not place large items in front of dispenser.
	Old detergent.	Use detergent within one to two months of purchase. To assure freshness, buy detergent as needed and no more than one or two at a time. Store in a cool, dry place.
Chipping and breakage of dishes/glasses	Improper loading.	Load with care following the instructions for use. Place glassware so it does not touch the other dishes. Remove from dishwasher carefully.
Odour in dishwasher	Dishes washed only every two or three days.	Use the pre-wash cycle at least once a day until a load accumulates, or hand rinse dishes before loading dishwasher.
	A dirty filter system may contribute to a bad odour.	Clean filter system.

YOUR GUARANTEE

Product Guarantee Details (UK only)

Your appliance has the benefit of a comprehensive manufacturer's guarantee which covers the cost of breakdown repairs. (Details of which are shown on your Proof of Purchase Document).

- Any claim during the period of the guarantee (MUST BE ACCOMPANIED BY THE PROOF OF PURCHASE)
- The product must be correctly installed and operated in accordance with the manufacturer's instructions and used for normal domestic purposes.
- This guarantee does not cover accidental damage, misuse or alterations which are likely to affect the product.
- The guarantee is invalid if the product is tampered with, or repaired by any unauthorised person.

(The guarantee in no way affects your statutory or legal rights)

What to do if you need to report a problem-

Please ensure you have ready:

- The product's model & serial numbers
- Howdens Proof of Purchase document
- Your full contact details.

Call the Lamona Service Line on 0845 00 60 006

Product Fiche

Commission Regulation (EU) No 1059/2010

LAMONA

Model	LAM8603
Place settings	12
Energy Class	A+
A _{Ec}	291 kWh/a
E _t	1.03kWh
P _o	0.08W
P _i	0.42W
A _{Wc}	3920 L
Drying class	A
Standard program	Eco 50°
Program time	165mins
Noise	49dB
Installation	Built In

Printed in Turkey
Part no: 15 0117 01 00
Revision: AA-10/14