

D i s h w a s h e r

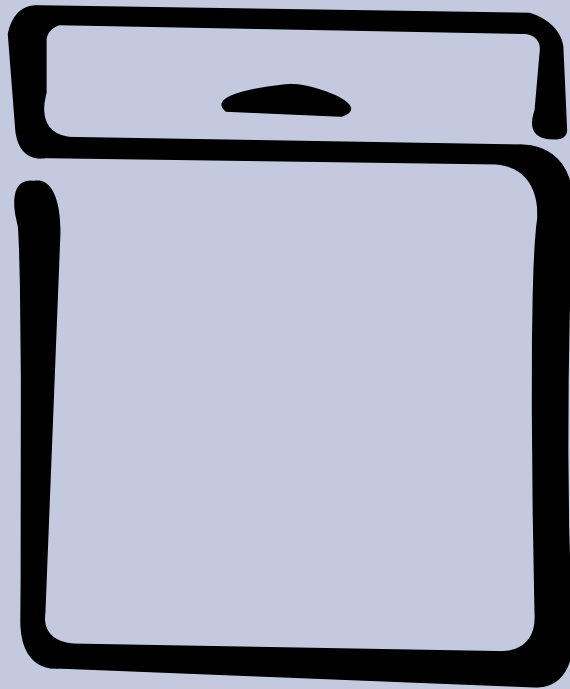

Model ESL 6115

UK Instruction book

 **Electrolux**

 11/04

Contents

Safety instructions	3	Installation instructions	18
Disposal	3	Building-in	18
Economical and ecological dishwashing	3	Levelling	18
Description of the appliance	4	Fixing to adjacent units	18
The control panel	5	Water supply connections	18
Audible signals	5	Water outlet hose connection	19
Prior to using for the first time	6	Electrical connection	19
Setting the water softener	6	Hints for test centres	20
Filling with dishwasher salt	7		
Rinse aid	7		
In daily use	8		
Loading cutlery and dishes	8		
The lower basket	8		
The cutlery basket	8		
The upper basket	9		
Adjusting the height of the upper basket	9		
Use of detergent	9		
Different kinds of detergent	10		
Washing programmes	11		
Starting a washing programme	12		
Maintenance and cleaning	13		
Cleaning the filters	13		
Prolonged periods of non-operation	13		
Frost precautions	13		
Moving the machine	13		
What to do, when...	14		
Service and Spare Parts	16		
Customer Care Department	16		
Guarantee Conditions	17		

Technical specifications

Dimensions	Width	59.6 cm
	Height	81.8 - 87.8 cm
	Max depth	55.5 cm
	Max depth with open door	114 cm
Electrical connection: Voltage Overall power Fuse	Information on the electrical connection is given on the rating plate on the inner edge of the dishwasher's door.	
Water supply pressure	Minimum Maximum	50 kPa (0.5 bar) 800 kPa (8 bar)
Capacity	12 place settings	



This appliance complies with the following E.E.C. Directives:

- 73/23 or 19.2.73 (Low Voltage Directive) and subsequent modifications;

- 89/336 or 3.5.89 (Electromagnetic Compatibility Directive) and subsequent modifications.

Safety instructions

It is most important that this instruction book should be retained with the appliance for future reference. Should the appliance be sold or transferred to another owner, or should you move house and leave the appliance, always ensure that the book is left with the appliance in order that the new owner can get to know the functioning of the appliance and the relevant safety information.

This information has been provided in the interest of your safety. You **MUST** read it carefully before installing or using the appliance.

Installation

- Check your dishwasher for any transport damage. Never connect a damaged machine. If your dishwasher is damaged, you should contact your supplier.
- For safety reasons it is dangerous to alter the specifications or attempt to modify this product in any way.
- Any electrical and plumbing work required to install this appliance should be carried out by a qualified and competent person.
- Care must be taken to ensure that the appliance does not stand on the electrical supply cable.
- The sides of the dishwasher must never be drilled to prevent damage to hydraulic components.

Child safety

- This appliance is designed to be operated by adults.
- Children should not be allowed to tamper with the controls or play with the product.
- Packaging parts may be dangerous for children, who could even be suffocated! You should therefore keep all packaging well away from children.
- The water in your dishwasher is not for drinking. Detergent residues may still be present in your machine. Keep children well away from your dishwasher when the door is open.
- Keep all detergents in a safe place out of children's reach.

Your dishwasher in day-to-day use

- Items that are contaminated by petrol, paint, steel or iron debris, corrosive, acidic or alkaline chemicals must not be washed in this dishwasher.
- Under no circumstances should you open the door whilst the appliance is in operation, especially during the washing phase, hot water may escape. However, if the door is opened, a safety device ensures that the machine stops.
- Only use products (detergent, salt and rinse aid) specifically designed for use in dishwashers.
- Long bladed knives stored in an upright position are a potential hazard.
- Long and/or sharp items of cutlery such as carving knives must be positioned horizontally in the upper basket.
- Ensure that the door of the dishwasher is always closed when it is not being loaded or unloaded. In this way you will avoid anybody tripping over the open door and hurting themselves.
- When finishing loading or unloading close the door, as an open door can be a hazard.
- Do not sit or stand on the open door.
- Isolate the appliance from the power supply and turn off the water supply after use.
- This product should be serviced by an authorised service engineer, and only genuine spare parts should be used.

- Under no circumstances should you attempt to repair the machine yourself. Repairs carried out by inexperienced persons may cause injury or serious malfunctioning. Contact your local Service Force Centre. Always insist on genuine spare parts.

Disposal

Dispose of the dishwasher packaging material correctly. All packaging materials can be recycled.

Plastic parts are marked with standard international abbreviations:

>PE< for polyethylene, e.g. sheet wrapping material.

>PS< for polystyrene, e.g. padding material (always CFC-free).

>POM< for polyoxymethylene, e.g. plastic clips.

Cardboard packaging is manufactured from recycled paper and should be deposited in the waste paper collection for recycling.

As and when you cease to use your dishwasher and withdraw it from service, you should render it unserviceable before having it disposed of.

Warning! Children at play could lock themselves in your dishwasher or otherwise endanger their lives. Therefore cut off the power supply cable and make the door closing device unusable to prevent children from being trapped inside.

For the disposing of the appliance please take it to a recycling centre or to your dealer who may, for a small contribution to the costs, dispose it for you.

Economical and ecological dishwashing

- Ensure that the water softener is correctly adjusted.
- Do not pre-wash under running water.
- Select the wash programme to suit the nature and degree of the soiling on the dishes.
- Do not use more detergent, dishwasher salt and rinse aid than is recommended in these operating instructions and by the manufacturer of the respective product.

Description of the appliance

1. Upper basket stop
2. Water hardness dial
3. Salt container
4. Detergent dispenser
5. Control panel
6. Rating plate
7. Rinse aid dispenser
8. Filters
9. Lower spray arm
10. Upper spray arm
11. Upper basket

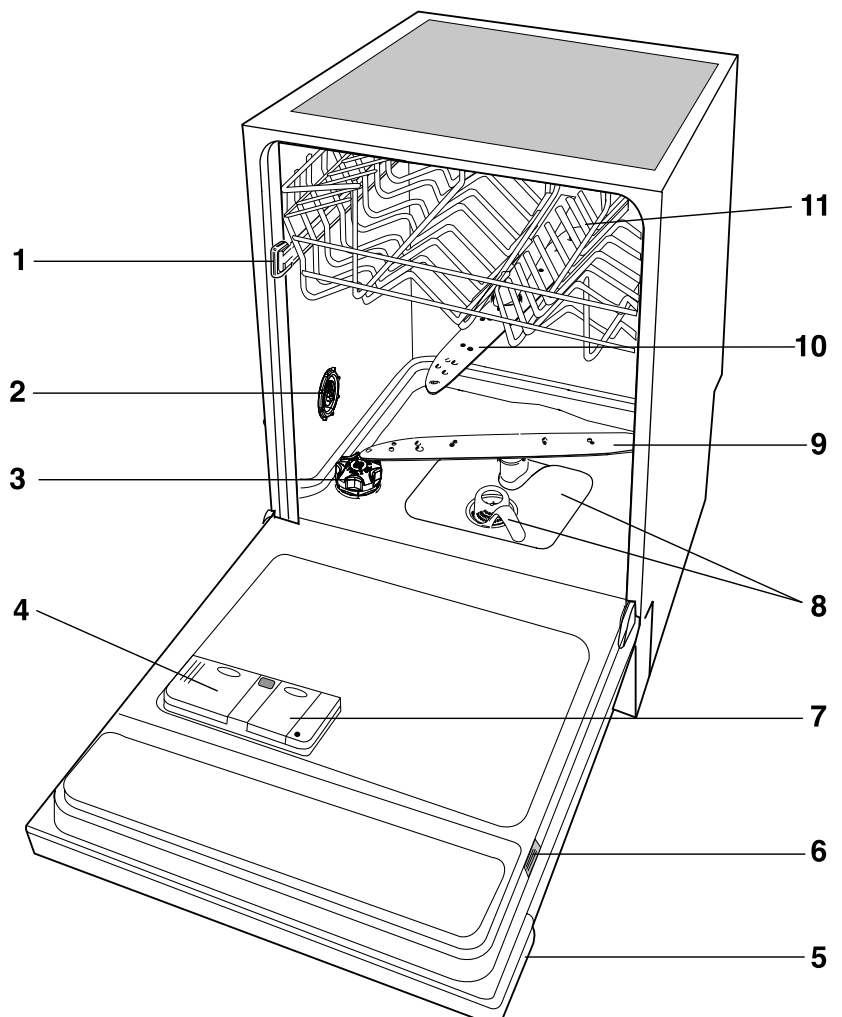

The control panel

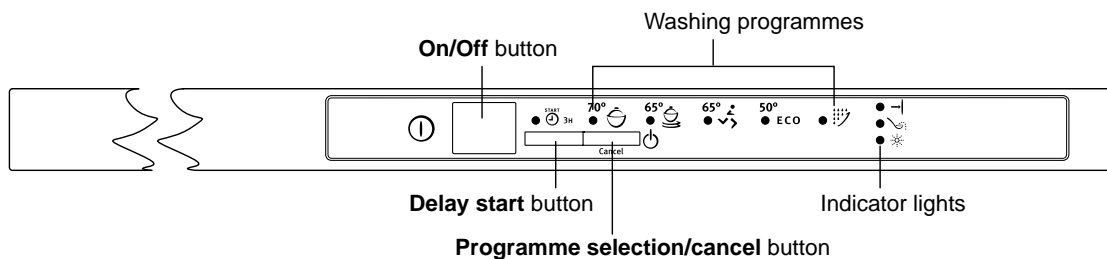

Programme indicator lights

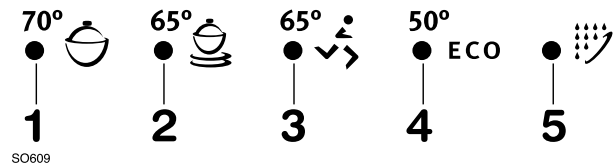

"Programme selection/cancel" button: the selection of a washing programme occurs by the means of this button, press it until the indicator light corresponding to the desired washing programme illuminates (see "Washing programmes" chart). The **end of programme** indicator light flashes.

Once the washing programme has been set, close the dishwasher's door, the programme will start automatically.

With this button it is also possible to:

- cancel a washing programme in progress,
- set the level of the water softener (see specific paragraph),
- deactivate/activate the audible signals.

"Delay start" button: this option allows the start of the washing programme to be delayed by 3 hours; the corresponding indicator light turns on.

Indicator lights: have the following meanings:

End of programme	illuminates when the washing programme has ended. It also has added functions of visual signalling as: - the setting of the water softener, - deactivation/activation of the audible signals, - intervention of an alarm due to the malfunction of the machine.
Salt	refilling indicator light: illuminates when the salt has run out.
Rinse aid	refilling indicator light: illuminates on when the rinse aid has run out.

Audible signals

Audible signals have been introduced to help indicate which operations the dishwasher is performing.

- end of washing programme,
- the setting of the water softener,
- malfunction of the machine.

Deactivation/activation of the audible signals

Factory setting: **audible signals activated.**

1. With the dishwasher switched off, press the On/Off button. The **end of programme** indicator light flashes (setting mode).

In case salt and/or rinse aid refilling is necessary the corresponding indicator lights illuminate.

If one of the washing programme indicator lights is on, this means that a washing programme has been set.

*The setting must be cancelled: press for about 3 seconds the **programme selection/cancel** button; the indicator light of the set programme turns off and the **end of programme** indicator light flashes, indicating that the set programme has been cancelled and that the machine is now in setting mode.*

2. Press and keep pressed the **programme selection/cancel** button until the programme indicator light 1 illuminates and programme indicator light 2 flashes.

Press the **programme selection/cancel** button again, the programme indicator light 1 starts flashing and the programme indicator light 2 turns on with a fixed light to indicate that you have activated the function for the deactivation/activation of the audible signals.

The constant illumination of the **end of programme** indicator light means that the audible signals are activated.

3. To deactivate the audible signals, press the **programme selection/cancel** button again, the **end of programme** indicator light turns off indicating that the audible signals are deactivated.

5. To memorise the operation, switch off the machine by pressing the On/Off button or wait for about 60 seconds, after which the machine will automatically return to setting mode.

To activate again the audible signals simply follow the above operations until the **end of programme** indicator light illuminates.

Prior to using for the first time

Before using your dishwasher for the first time:

1. Ensure that the electrical and water connections comply with the installation instructions
2. Remove all packaging from inside the appliance
3. Set the water softener
4. Pour 1 litre of water inside the salt container and then fill with dishwasher salt
5. Fill the rinse aid dispenser

The water softener

The dishwasher is equipped with a water softener designed to remove minerals and salts from the water supply, which would have a detrimental or adverse effect on the operation of the appliance.

The higher the content of these minerals and salts, the harder your water is.

Water hardness is measured in equivalent scales, Clarke degrees, French degrees (°TH) and mmol/l (millimol per litre - international unit for the hardness of water).

The softener should be set to adjusted according to the hardness of the water in your area. Your local Water Authority can advise you on the hardness of the water in your area.

The water softener must be set in both ways: manually, using the water hardness dial and electronically, by the means of the **programme selection/cancel** button.

a) Setting manually

1. Open the dishwasher door.
2. Remove the lower basket from the dishwasher.
3. Turn the water hardness dial to position 1 or 2 (see table).
4. Replace the lower basket.

The dishwasher is factory set at position 2.

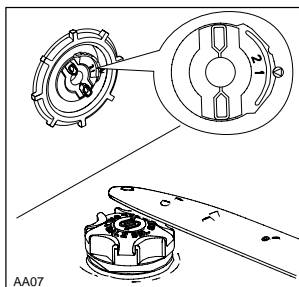

b) Setting electronically

The dishwasher is factory set at level 5.

1. With the dishwasher switched off, press the On/Off button. The **end of programme** indicator light flashes (setting mode).

In case salt and/or rinse aid refilling is necessary the corresponding indicator lights illuminate.

If one of the washing programme indicator lights is on, this means that a washing programme has been set.

*The setting must be cancelled: press for about 3 seconds the **programme selection/cancel** button; the indicator light of the set programme turns off and the **end of programme** indicator light flashes, indicating that the set programme has been cancelled and that the machine is now in setting mode.*

2. Press and keep pressed the **programme selection/cancel** button until the programme indicator light 1 illuminates and programme indicator light 2 flashes, indicating that you have activated the water softener setting function.

After a few seconds the **end of programme** indicator light starts flashing.

The current level is indicated by a sequence of flashes of the **end of programme** indicator light, a sequence of intermittent audible signals and a pause of a few seconds (see chart).

Example: 5 flashes/5 audible signals + pause + 5 flashes/5 audible signals etc...= level 5

3. To change the level, press the **programme selection/cancel** button. Each time the button is pressed the level changes. (For the selection of the new level, see chart).

Examples:

if the current level is 5, by pressing the **programme selection/cancel** button once, level 6 is selected.

if the current level is 10, by pressing the **programme selection/cancel** button once, level 1 is selected.

The **end of programme** indicator light remains off for a few seconds and then starts flashing indicating the new selection is set.

5. To memorise the operation, switch off the machine by pressing the On/Off button or wait for about 60 seconds, after which the machine will automatically return to setting mode.

Water hardness				Adjusting the water hardness setting		Number of flashes of the "end of programme" indicator light and of audible signals	Use of salt
Clarke degrees	°TH	mmol/l	Range	manually	electronically		
64 - 88	91 - 125	9,0 - 12,5	IV	2	level 10	10	yes
53 - 63	76 - 90	7,6 - 8,9	IV	2	level 9	9	yes
46 - 52	65 - 75	6,5 - 7,5	IV	2	level 8	8	yes
36 - 45	51 - 64	5,1 - 6,4	IV	2	level 7	7	yes
28 - 35	40 - 50	4,0 - 5,0	IV	2	level 6	6	yes
23 - 27	33 - 39	3,3 - 3,9	III	2	level 5	5	yes
18 - 22	26 - 32	2,6 - 3,2	III	1	level 4	4	yes
13 - 17	19 - 25	1,9 - 2,5	II	1	level 3	3	yes
5 - 12	7 - 18	0,7 - 1,8	I/II	1	level 2	2	yes
< 5	< 7	< 0,7	I	1	level 1	1	no

Filling with dishwasher salt

Only use salt specifically designed for use in dishwashers.

All other types of salt not specifically designed for use in a dishwasher, especially table salt, will damage the water softener.

Only fill with salt just before starting one of the complete washing programmes.

This will prevent any grains of salt or salty water, which may have been spilt, remaining on the bottom of the machine for any period of time, which may cause corrosion.

To fill:

1. Open the door, remove the lower basket and unscrew the cap of the salt container by turning it anticlockwise.
2. Pour 1 litre of water inside the container (**this is necessary only before filling with salt for the first time**).

3. Using the funnel provided, pour in the salt until the container is full.
4. Replace the cap making sure that there is no trace of salt on the screw thread or on the gasket.
5. Replace on the cap tightly turning it clockwise until it stops with a click.

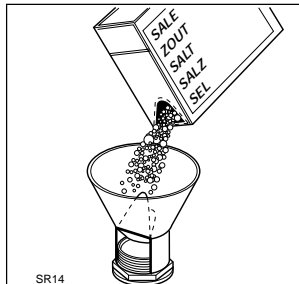

The salt container will require topping up periodically. You are reminded of this by the salt indicator light on the control panel which comes on when the salt has finished.

The salt indicator light on the control panel can remain illuminated for 2-6 hours after the salt has been replenished, assuming the dishwasher remains switched on. If you are using salts that take longer to dissolve then this can take longer. The function of the machine is not affected.

Do not worry if water over flows from the unit when filling with salt, this is quite normal.

Rinse aid

Rinse aid is automatically added during the last rinse, ensuring thorough rinsing, and spot and streak free drying.

The dispenser, which is positioned inside the door, holds about 110 ml of rinse aid, which is sufficient for 16 - 40 dishwashing programmes, depending upon the dosage setting.

Filling with rinse aid

1. Open the container by pressing the release button (A).
2. Add the rinse aid until the container is completely full. The maximum level for filling is indicated by "max".

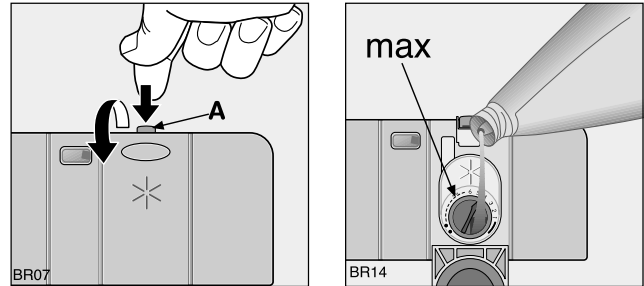

Ensure that the lid is closed after every refill.

Clean up any rinse aid spilt during filling with an absorbent cloth to avoid excess foaming during the next wash.

Only use branded rinse aid for dishwashers. Never fill the rinse aid dispenser with any other substances (e.g. dishwasher cleaning agent, liquid detergent). This would damage the appliance.

Adjusting the dose

According to the finish and drying results obtained, adjust the dose of rinse aid by means of the 6 position selector (position 1 minimum dosage, position 6 maximum dosage).

The dose is factory set in position 4.

Increase the dose if there are drops of water or lime spots on the dishes after washing.

Reduce it if there are sticky whitish streaks on the dishes or a bluish film on glassware or knife blades.

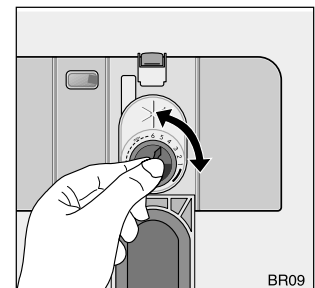

Top up the rinse aid when the indicator light on the control panel illuminates.

In daily use

- Check if it's necessary to refill with dishwasher salt or rinse aid
- Load cutlery and dishes into the dishwasher.
- Fill with dishwasher detergent .
- Select a wash programme suitable for the cutlery and dishes.
- Start the wash programme.

Loading cutlery and dishes

Sponges, household cloths and any object that can absorb water may not be washed in the dishwasher.

- Before loading the dishes, you should:
 - Remove large left-overs.
 - Soften remnants of burnt food in pans
- When loading the dishes and cutlery, please note:
 - Dishes and cutlery must not impede the rotation of the spray arms .
 - Load hollow items such as cups, glasses, pans, etc. with the opening downwards so that water cannot collect in the container or a deep base.
 - Dishes and items of cutlery must not lie inside one another, or cover each other.
 - To avoid damage to glasses, they must not touch.
 - Lay small objects in the cutlery basket.
- **Plastic items and pans with teflon have a tendency to retain water drops; these items will not dry as well as porcelain and steel items.**

For washing in the dishwasher the following cutlery/dishes	
are not suitable:	are of limited suitability:
<ul style="list-style-type: none"> - Cutlery with wooden, horn, china or mother-of-pearl handles - Plastic items that are not heat resistant - Older cutlery with glued parts that is not temperature resistant - Bonded cutlery items or dishes - Pewter or copper items - Lead crystal glass - Steel items subject to rusting - Wooden platters - Items made from synthetic fibres 	<ul style="list-style-type: none"> - Only wash stoneware in the dishwasher if it is specifically marked as being dishwasher-safe by the manufacturer. - Glazed patterns may fade if machine washed frequently - Silver and aluminium parts have a tendency to discolour during washing. Residues, e.g. egg white, egg yolk and mustard often cause discolouring and staining on silver. Therefore always clean left-overs from silver immediately, if it is not to be washed straight after use. - Some types of glass can become dull after a large number of washes

Open the door and slide out the baskets to load the dishes.

The lower basket

The lower basket is designed to take saucepans, lids, plates, salad bowls, cutlery etc.

Serving dishes and large lids should be arranged around the edge of the basket, ensuring that the spray arms can turn freely.

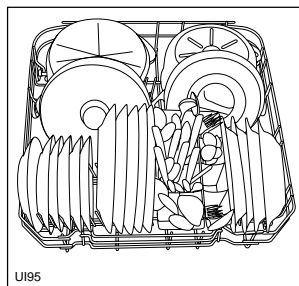
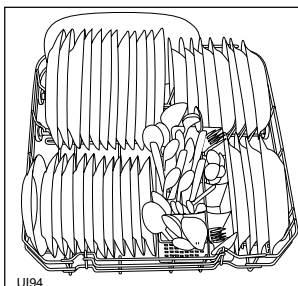

The cutlery basket

Long bladed knives stored in an upright position are a potential hazard.

Long and/or sharp items of cutlery such as carving knives must be positioned horizontally in the upper basket.

Take care when loading or unloading sharp items such as knives.

Forks and spoons should be placed in the removable cutlery basket with the handles facing downwards and the knives with their handles facing upwards.

If the handles protrude from the bottom of the basket, obstructing the lower spray arm, load the cutlery with the handles facing upwards.

Mix spoons with other cutlery to prevent them from sticking together.

For best results we recommend you to use the cutlery grid provided (if the size and dimensions of the cutlery allow it).

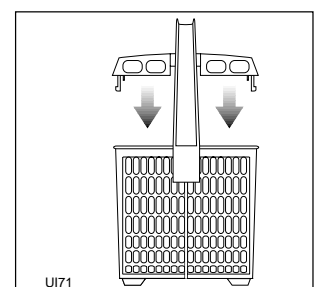

The upper basket

The upper basket is designed for plates (dessert plates, saucers, dinner plates of up to 24 cm in diameter), salad bowls, cups and glasses.

Arrange items on and underneath the cup racks so that water can reach all surfaces.

Glasses with long stems can be placed upside down in the cup racks.

For taller items, the cup racks can be folded upwards. Light items (plastic bowls etc.) must be loaded in the upper basket and arranged so they do not move.

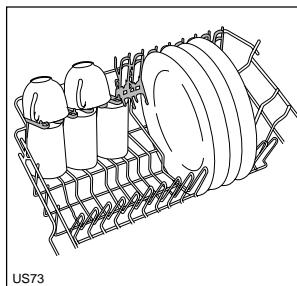
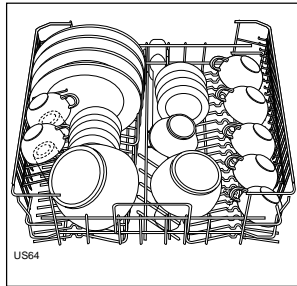

In case that plates are loaded in the upper basket:

load them starting from the rear positions of the basket; tilting them slightly forwards and avoiding the front positions near the door.

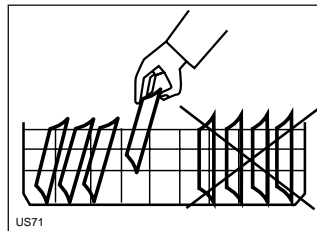

Before closing the door, ensure that the spray arms can rotate freely.

Adjusting the height of the upper basket

If washing very large plates you can load them in the lower basket after moving the upper basket to the higher position.

	Maximum height of the dishes in	
	upper basket	lower basket
With upper basket raised	20 cm	31 cm
With upper basket lowered	24 cm	27 cm

To move to the higher position proceed as follows:

1. Move the front runner stops (A) of the upper basket outwards and slide the basket out.
2. Refit the basket in the higher position and replace the stops (A) in their original position.

When the basket is in the higher position you will not be able to use the cup rack(s).

After loading your machine always close the door, as an open door can be a hazard.

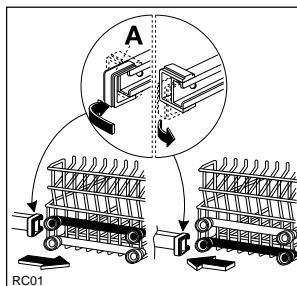

Use of detergent

Only use detergents specifically designed for use in dishwashers.

We recommend the use of Finish detergents.

Using no more than the correct amount of detergent contributes to reducing pollution.

Please observe the manufacturer's dosing and storage recommendations as stated on the detergent packaging.

Fill with detergent

1. If the lid is closed: press release button (1). The lid springs open.
2. Fill the detergent dispenser (2) with detergent. The marking indicates the dosing levels:
20 = approximately 20 g of detergent
30 = approximately 30 g of detergent

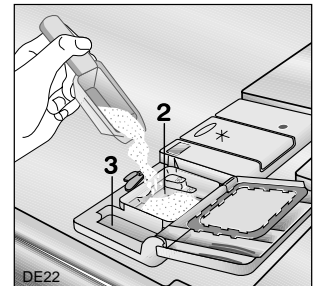
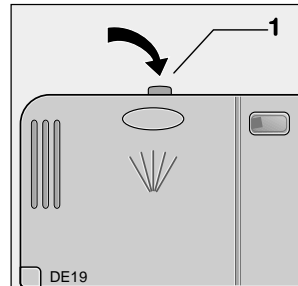

3. All programmes with prewash need an additional detergent dose (5/10 g) that must be placed in the prewash detergent chamber (3). This detergent will take effect during the prewash phase.
4. Close the lid and press until it locks in place.

Different kinds of detergent

Detergent tablets

Detergent tablets of different brands dissolve at different speeds. For this reason some detergent tablets cannot dissolve and develop their full cleaning power during short programmes. Therefore please use long programmes when using detergent tablets, to ensure the complete removal of detergent residuals.

Do not place the tablets in the tub or in the cutlery basket as this will result in poorer wash results. The tablets should be placed in the detergent dispenser.

Concentrated detergent

Based on their chemical composition, dishwasher detergents can be split into two basic types:

- conventional, alkaline detergents with caustic components.
- low alkaline concentrated detergents with natural enzymes.

The use of 50°C washing programmes in conjunction with concentrated detergents reduces pollution and is good for your dishes; these wash programmes are specially matched to the dirt-dissolving properties of the enzymes in the concentrated detergent. For this reason 50°C wash programmes in which concentrated detergents are used can achieve the same results that can otherwise only be achieved using 65°C programmes.

Combi detergents

If you are using dishwasher detergent that includes the rinse aid function, this must be placed in the detergent compartment.

In this case the rinse aid dispenser must be empty, in order to avoid a double dosage.

If in the rinse aid dispenser there is still rinse aid you must wait until it has finished before using these kind of detergents.

Use of "3 in 1" combi detergents

General advice

These products are detergents with integrated and combined detergent/rinse-aid and salt functions.

1. **Before using these products you should first check that the water hardness in your supply is compatible with the use of these products as per the detergent manufacturers (on the product packaging).**
2. These products should be strictly used according to the detergent manufacturers instructions.
3. If you encounter problems when using 3 in 1 products for the first time then please contact the detergent manufacturers care line (the telephone number is given on the product packaging).

Special advice

When using combination 3 in 1 products select the lowest possible setting for water hardness.

If you decide to turn back to the use of the standard detergent system we advise that you:

- Refill both the salt container and rinse aid dispenser.
- Switch the water hardness setting to the highest possible position and run from 1 to 3 normal washing programmes without a load.
- Readjust the water hardness setting again according to the hardness of the water in your area.

NOTE: When using dishwasher detergents with integrated and combined detergent/rinse-aid functions, the refilling of the rinse aid dispenser is no longer necessary.
Special salt for dishwasher **must** still be used.
In this case the rinse aid indicator light will always remain illuminated when the machine is switched on (*not all dishwasher models are foreseen with rinse aid indicator light*).





NOTE: When using dishwasher detergents with integrated and combined detergent/rinse-aid/salt functions, the refilling of the salt container and the rinse aid dispenser are no longer necessary.
In this case the salt and the rinse aid indicator lights will always remain illuminated when the machine is switched on (*not all dishwasher models are foreseen with salt and rinse aid indicator lights*).

For best results we recommend the use of Finish detergents, rinse aid and salt.



DE15

Washing programmes

Programme	Degree of soil and type of load	Cycle description	(3) Consumption values		
			Programme duration (in minutes)	Energy consumption (in kWh)	Water consumption (in litres)
Intensive 70°C 	Heavy soil. Crockery, cutlery, pots and pans	Hot prewash Main wash up to 70°C 2 warm rinses 1 hot rinse Drying	120 - 130	1,7 - 1,9	23 - 25
Normal 65°C 	Normal soil. Crockery and cutlery	Cold prewash Main wash up to 65°C 2 warm rinses 1 hot rinse Drying	108 - 118	1,7 - 1,8	24 - 26
(1) Quick 65°C 	Fresh soil. Crockery and cutlery	Main wash up to 65°C 1 hot rinse	25 - 35	0,7 - 0,8	8
(2) Bio 50°C	Normal soil. Crockery and cutlery	Cold prewash Main wash up to 50°C 1 cold rinse 1 hot rinse Drying	136 - 146	0,95 - 1,05	13 - 15
Rinse and Hold 	Any. Partial load (to be completed later in the day).	1 cold rinse (to avoid food scraps from sticking together). This programme does not require the use of detergent.	12	< 0,1	4

- (1) Ideal for washing crockery and cutlery of breakfast and dinner (**fresh soil**).
This is the perfect daily programme, made to meet the needs of a family of **4 persons** who only wish to load breakfast and dinner crockery and cutlery.
- (2) Testing programme for EN 50242 (see "Hints for Test Centres"). This programme, developed for the use of detergents with enzymes, allows you to achieve, with reduced consumption of energy the same cleaning results that would otherwise be obtained only with the 65°C programmes and conventional detergents. To compensate the lower temperature, the duration of washing and drying have been extended.
- (3) The consumption values are intended as a guide and depends on the pressure and the temperature of the water and also by the variations of the power supply.

With programmes **Intensive 70°C** and **Normal 65°C** the water temperature of the last rinse will be kept above 65°C for at least 10/11 minutes. This allows a greater degree of hygiene of dishes and glasses, or jam jars.

Starting a washing programme

In this fully integrated appliance the controls are located on the top of the door. When selecting a washing programme, the door needs to be slightly open.

1. Check that the baskets have been loaded correctly and that the spray arms can rotate freely

2. Turn on the water tap

3. Setting and starting the washing programme

Press the On/Off button.

The **end of programme** indicator light flashes.

Press the **programme selection/cancel** button and select the desired washing programme. To choose the right washing programme see "Washing programmes" chart). Close the dishwasher's door, the programme will start automatically.

Setting the "delay start" of a washing programme

Once the setting of the desired washing programme has occurred, press the "delay start" button.

The corresponding indicator light turns on.

Close the dishwasher's door, the countdown for the delay start begins automatically.

The opening of the door will not modify or interrupt the countdown.

Once the delay start has elapsed the programme will start automatically.

To cancel a "delay start" in progress

Open the dishwasher's door and press the **delay start** button, the corresponding indicator light turns off. Close the door, the set programme will start automatically.

NOTE: the start of the washing programme or the countdown of the delay start will occur only after the closure of the door. Until that moment you can modify the selection made.

4. To interrupt or cancel a washing programme in progress

Interrupt or cancel a washing programme in progress ONLY if it's absolutely necessary.

Attention! Hot steam may escape when the door is opened. **Open the door carefully.**

To interrupt a washing programme in progress

Open the dishwasher's door; the programme will stop. Close the door; the programme will start from the point at which it was interrupted.

To cancel a washing programme in progress

Open the dishwasher's door. Press the **programme selection/cancel** button for about 3 seconds, until the indicator light of the running programme turns off and the **end of programme** indicator light flashes, indicating that the running programme has been cancelled and that the machine has returned to setting mode.

It is now possible to select another washing programme. *If a new washing programme will be selected, check that there is detergent in the detergent dispenser.*

NOTE: **only** during the drying phase, if the dishwasher's door will be opened and remains open for more than 30 seconds, the running programme will be automatically cancelled and the machine will return to setting mode. This will happen, always **only** during the drying phase, also when the machine is switched off by pressing the On/Off button and remains switched off for more than 30 seconds.

5. End of the washing programme

The dishwasher will automatically stop. An audible signal informs you of the end of the washing programme.

Open the dishwasher's door, the **end of programme** indicator light is on.

The indicator light of the programme just ended is on.

Switch off the dishwasher by pressing the On/Off button.

Wait a few minutes before removing the dishes; in this way they will be cooler and the drying will be improved.

6. Unloading the dishwasher

Hot dishes are sensitive to knocks. The dishes should therefore be allowed to cool down before removing from the appliance.

Empty the lower basket first and then the upper one; this will avoid water dripping from the upper basket onto the dishes in the lower one.

Water may appear on the sides and the door of the dishwasher as the stainless steel will eventually become cooler than the dishes.

When the washing programme has finished, it is recommended that the dishwasher is unplugged and the water tap turned off.

Maintenance and cleaning

Clean the external surfaces of the machine and control panel with a damp soft cloth. If necessary use only neutral detergents. Never use abrasive products, scouring pads or solvent (acetone, trichloroethylene etc....).

Ensure that the seals around the door, the detergent and rinse aid dispensers are cleaned regularly with a damp cloth.

We recommend the use of **Finish Dishwasher Cleaner** every 3 months or run a 65°C wash programme without dishes using detergent.

Regular use of **Finish Dishwasher Cleaner** cleans inaccessible parts, eliminates unpleasant food odours and helps prevent the build-up of limescale.

Cleaning the filters

The filters must be checked and cleaned from time to time. Dirty filters will degrade the washing result.

1. Open the door, remove the lower basket.
2. The dishwasher filter system comprises a coarse filter (A), a microfilter (B) and a flat filter (C).
Unlock the filter system using the handle on the microfilter, and remove.

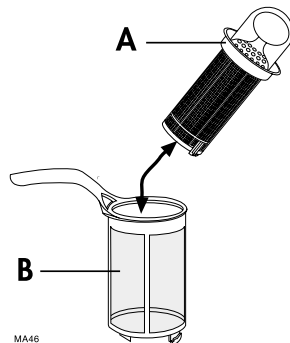

3. Turn the handle about 1/4 a turn anticlockwise and remove.

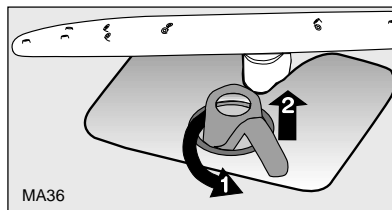

4. Take hold of the coarse filter (A) by the handle with the hole and remove from the microfilter (B).
5. Clean all filters thoroughly under running water.
6. Remove the flat filter (C) from the base of the washing compartment and clean both faces thoroughly.

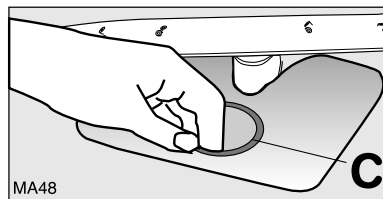

7. Put the flat filter (C) back in the base of the washing compartment.
8. Place the coarse filter (A) in the microfilter (B) and press together.
9. Put the filter combination in place and lock by turning the handle clockwise to the stop. During this process ensure that the flat filter does not protrude above the base of the washing compartment.

Attention!

Under no circumstances may the dishwasher be used without filters.

Incorrect repositioning and fitting of the filters will produce poor washing results.

NEVER try to remove the upper spray arm.

If residues of soil have clogged the holes in the upper spray arm, remove them with a toothpick.

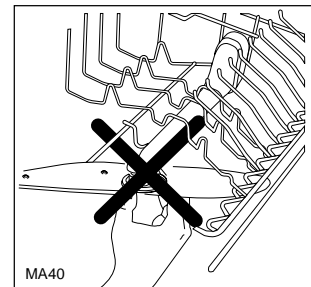

Prolonged periods of non-operation

If you are not using the machine for any period of time you are advised to:

1. Unplug the appliance and then turn off the water.
2. Leave the door ajar to prevent the formation of any unpleasant smells.
3. Leave the inside of the machine clean.

Frost precautions

Avoid placing the machine in a location where the temperature is below 0°C. If this is unavoidable, empty the machine, close the appliance door, disconnect the water inlet pipe and empty it.

Moving the machine

If you have to move the machine (moving house etc....):

1. Unplug it.
2. Turn the water tap off.
3. Remove the water inlet and discharge hoses.
4. Pull the machine out together with the hoses.

Avoid over tilting the machine during transportation.

What to do, when...

Certain problems are due to the lack of simple maintenance or oversights, which can be solved with the help of the instructions given here, without calling out an engineer.

...a fault code appears

The dishwasher will not start or stops during operation.

Open the dishwasher's door.

The intervention of an alarm is indicated by:

- continuous flashing of the indicator light of the running programme,
- a combination of flashes and pauses of the **end of programme** indicator light and by intermittent audible signals (as described in the chart).

Carry out the following suggested corrective actions.

Important: If you call out an engineer to a fault listed below or to repair a fault caused by incorrect use or installation a charge will be made, even if the appliance is in guarantee.

Fault code / malfunction	Possible cause	Solutions
continuous flashing of the indicator light of the running programme 1 intermittent audible signal 1 flash of the "end of programme" indicator light The machine does not fill with water.	The water tap is blocked or furred with limescale.	Clean the water tap.
	The water tap is turned off.	Turn the water tap on.
	The filter (where present) in the threaded hose fitting at the water inlet valve is blocked.	Clean the filter in the threaded hose fitting.
	The water inlet hose has not been correctly laid or it is bent or squashed.	Check the water inlet hose connection.
continuous flashing of the indicator light of the running programme 2 intermittent audible signals 2 flashes of the "end of programme" indicator light The dishwasher will not drain.	The sink spigot is blocked.	Clean out the sink spigot.
	The water drain hose has not been correctly laid or it is bent or squashed.	Check the water drain hose connection.

Once the checks have been carried out, press the **programme selection/cancel** button and close the dishwasher's door. The programme will continue from the point at which it was interrupted. If the fault code reappears contact our local Service Force Centre.

For other combinations of fault codes not described in the above chart, please contact your local Service Force Centre.

...there are problems when operating the dishwasher

Malfunction	Possible cause	Solutions
The programme does not start	The dishwasher door has not been properly closed.	Close the door.
	The main plug is not plugged in.	Insert the mains plug.
	The fuse has blown in the household fuse box.	Replace the fuse.
	For dishwasher models with delay start option: Delay start has been selected.	If dishes are to be washed immediately, cancel the delay start.
There is a whistling noise during washing	The whistling is not a cause for concern.	Use a different brand of detergent.

...the wash results are not satisfactory

The dishes are not clean

- The wrong washing programme has been selected.
- The dishes were arranged in such a way as to stop water reaching all parts of the surface. The baskets must not be overloaded.
- The spray arms do not rotate freely due to wrong arrangement of the load.
- The filters in the base of the washing compartment are dirty or incorrectly positioned.
- Too little or no detergent has been used.
- Where there are limescale deposits on the dishes; the salt container is empty or the wrong level of the water softener has been selected.
- The drain hose connection is not correct.
- The salt container cap is not properly closed.

The dishes are wet and dull

- Rinse aid was not used.
- The rinse aid dispenser is empty.

There are streaks, milky spots or a bluish coating on glasses and dishes

- Decrease rinse aid dosing.

Water drops have dried onto glasses and dishes

- Increase rinse aid dosing.
- The detergent may be the cause. Contact the detergent manufacturer's consumer care line.

If after all these checks, the problem persists, contact your local Service Force Centre, quoting the model (Mod.), product number (PNC) and serial number (S.N.).

This information can be found on the rating plate located on the side of the dishwasher door (see picture).

So that you always have these numbers at hand, we recommend you to make a note of them here:

Mod. :

PNC :

S.N. :

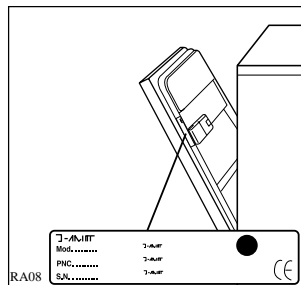

This product should be serviced by an authorised service engineer, and only genuine spare parts should be used. Under no circumstances should you attempt to repair the machine yourself.

Repairs carried out by inexperienced persons may cause injury or serious malfunctioning. Contact your local Service Force Centre.

Always insist on genuine spare parts.

Service and Spare Parts



In the event of your appliance requiring service, or if you wish to purchase spare parts please contact your local Service Force Centre by telephoning:

08705 929929

Your telephone call will be automatically routed to the Service Force Centre covering your post code area.

For the address of your local Service Force Centre and further information about Service Force, please visit the website at www.serviceforce.co.uk

Before calling out an engineer, please ensure you read the details under the heading "What to do, when...".

When you contact the Service Force Centre you will need to give the following details:

1. Your name, address and post code
2. Your telephone number
3. Clear and concise details of the fault
4. The model and serial number of the appliance (found on the rating plate)
5. The purchase date

Please note that a valid purchase receipt or guarantee documentation is required for in-guarantee service calls.

For Customer Service in The Republic of Ireland please contact us at the address below:

Electrolux Group (Irl) Ltd
Long Mile Road
Dublin 12
Republic of Ireland
Tel: + 353 (0)1 4090751
Email: service.eid@electrolux.ie

Customer Care Department

For general enquiries concerning your Electrolux appliance or for further information on Electrolux products, please contact our Customer Care Department by letter or telephone at the address below or visit our website at:

www.electrolux.co.uk

Customer Care Department
Electrolux
55-77 High Street
Slough
Berkshire
SL1 1DZ
Tel: 08705 950950 (*)

** calls to this number may be recorded for training purposes*

Guarantee Conditions

Standard Guarantee Conditions

We, Electrolux, undertake that if within 12 months of the date of purchase this **Electrolux** appliance or any part thereof is proved to be defective by reason only of faulty workmanship or materials, we will, at our option repair or replace the same **FREE OF CHARGE** for labour, materials or carriage on condition that:

- The appliance has been correctly installed and used only on the electricity supply stated on the rating plate.
- The appliance has been used for normal domestic purposes only, and in accordance with the manufacturer's instructions.
- The appliance has not been serviced, maintained repaired, taken apart or tampered with by any person not authorised by us.
- All service work under this guarantee must be undertaken by a Service Force Centre.
- Any appliance or defective part replaced shall become the Company's property.
- This guarantee is in addition to your statutory and other legal rights.

Home visits are made between **8.30am** and **5.30pm** Monday to Friday. Visits may be available outside these hours in which case a **premium** will be charged.

Exclusions

This guarantee does not cover:

- Damage or calls resulting from transportation, improper use or neglect, the replacement of any light bulbs or removable parts of glass or plastic.
- Costs incurred for calls to put right an appliance which is improperly installed or calls to appliances outside the United Kingdom.
- Appliances found to be in use within a commercial environment, plus those which are subject to rental agreements.
- Products of Electrolux manufacture which are not marketed by Electrolux.

European Guarantee

If you should move to another country within Europe then your guarantee moves with you to your new home subject to the following qualifications:

- The guarantee starts from the date you first purchased your product.
- The guarantee is for the same period and to the same extent for labour and parts as exists in the new country of use for this brand or range of products.
- This guarantee relates to you and cannot be transferred to another user.
- Your new home is within the European Community (EC) or European Free Trade Area.
- The product is installed and used in accordance with our instructions and is only used domestically, i.e. a normal household.
- The product is installed taking into account regulations in your new country.

Before you move please contact your nearest Customer Care centre, listed below, to give them details of your new home. They will then ensure that the local Service Organisation is aware of your move and able to look after you and your appliance.

France	Senlis	+33 (0) 344 62 20 13
Germany	Nuremberg	+49 (0) 800 234 7378
Italy	Pordenone	+39 (0) 800 11 7511
Sweden	Stockholm	+46 (0) 20 78 77 50
UK	Slough	+44 (0) 1753 219898
Ireland	Dublin	+353 (0)1 4090753

Installation instructions

Any electrical and/or plumbing work required to install this appliance should be carried out by a qualified electrician and/or plumber or competent person.

Remove all packaging before positioning the machine.

If possible, position the machine next to a water tap and a drain.

Building-in

This dishwasher is designed to be fitted under a kitchen counter or worksurface.

Attention!

Carefully follow the instructions on the enclosed template for building in the dishwasher and fitting the furniture panel.

No further openings for the venting of the dishwasher are required, but only to let the water fill and drain hose and power supply cable pass through.

The dishwasher incorporates adjustable feet to allow the adjustment of the height.

During all operations that involve accessibility to internal components the dishwasher has to be unplugged.

When inserting the machine, ensure that the water inlet hose, the drain hose and the supply cable are not kinked or squashed.

Levelling

Good levelling is essential for correct closure and sealing of the door.

When the appliance is correctly levelled, the door will not catch on either side of the cabinet.

If the door does not close correctly, loosen or tighten the adjustable feet until the machine is perfectly level.

Fixing to the adjacent units

The dishwasher must be secured against tilting. Therefore make sure that the counter it is fixed under, is suitably secured to a fixed structure (adjacent kitchen units cabinets, wall).

Water supply connections

This dishwasher must be plumbed into a cold water supply.

For making the connection itself, the coupling nut fitted to the machine's supply hose is designed to screw onto a 3/4" inch gas thread spout.

The water pressure must be within the limits given in the "Technical specifications". Your local Water Authority will advise you on the average mains pressure in your area.

The water inlet hose must not be kinked, crushed, or entangled when it is being connected up.

The inlet hose must hang down vertically from the supply tap.

The dishwasher features fill and drain hoses which can be turned either to the left or the right to suit the installation by means of the locknut. **The locknut must be correctly fitted to avoid water leaks.** (*Attention! NOT all models of dishwashers have fill and drain hoses provided with locknut. In this case, this kind of facility is not possible.*)

If the machine is connected to new pipes or pipes which have not been used for a long time, you should run the water for a few minutes before connecting the inlet hose.

Do not use, for connection, old hoses which have been used in another appliance.

The dishwasher is fitted with safety devices that prevent the wash water returning into the drinking water system and comply with the applicable plumbing regulations.

Water outlet hose connection

The end of the drain hose can be connected in the following ways:

1. To the sink outlet spigot, securing it to the underside of the work surface. This will prevent waste water from the sink running into the machine.
2. Hooked over the edge of the sink using the special curved plastic guide (if provided with the machine).
3. To a stand pipe provided with vent-hole, minimum internal diameter 4 cm.

The waste connection must be at a height of between 30 cm (minimum) and 100 cm (maximum) from the bottom of the dishwasher.

The drain hose can face either to the right or left of the dishwasher

Ensure the hose is not bent or squashed as this could prevent or slow down the discharge of water.

The sink plug must not be in place when the machine is draining as this could cause the water to syphon back into the machine.

If you use a drain hose extension it must be no longer than 2 metres and its internal diameter must be no smaller than the diameter of the hose provided.

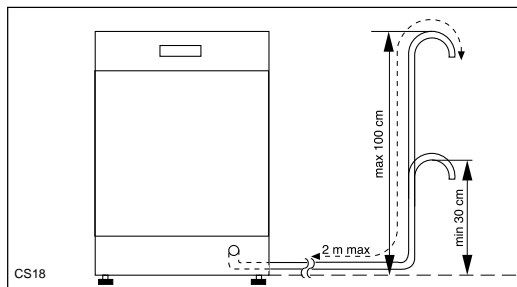

Likewise the internal diameter of the couplings used for connections to the waste outlet must be no smaller than the diameter of the hose provided.

Attention!

Our appliances are supplied with a security device to protect against the return of dirty water back into the machine. If the spigot of your sink has a "no return valve" incorporated this can prevent the correct draining of your dishwasher. We advise you therefore to remove it.

Electrical connection

This appliance must be earthed.

The manufacturer declines any responsibility should this safety measure not be observed.

If the plug that is fitted to your appliance is not suitable for the socket, it must be cut off and the appropriate plug fitted.

Important

The wires on the mains lead are coloured in accordance with the following code:

Green and Yellow - Earth

Blue - Neutral

Brown - Live

If you fit your own plug, the colours of the wires in the mains lead of your appliance may not correspond with the markings identifying the terminals in your plug.

Proceed as follows:

1. Connect the Green and Yellow (earth) wire to the terminal in the plug which is marked with the letter "E" or the earth symbol \oplus or coloured green and yellow.
2. Connect the Blue (neutral) wire to the terminal in the plug which is marked with the letter "N" or coloured black.
3. Connect the Brown (live) wire to the terminal in the plug which is marked with the letter "L" or coloured red.

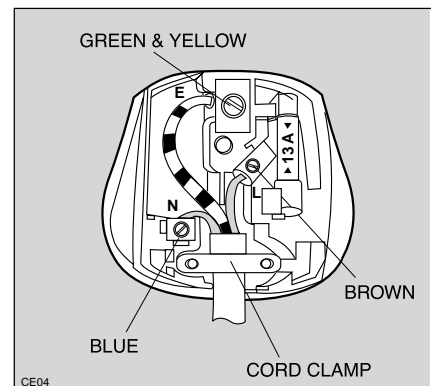

The plug moulded onto the lead incorporates a 13amp BSI362 fuse. Only ASTA or BSI fuses should be used.

The plug must not be used if the fuse cover/carrier is lost. The cover/carrier is indicated by the coloured insert at the base of the plug.

A replacement cover/carrier must be obtained from your local Service Force Centre.

To isolate the dishwasher from mains, remove the mains plug.



Important!

The plug must still be accessible after the appliance has been installed.

The appliance should not be connected to the electrical supply by means of an extension cable.

In case that the electrical cable has to be replaced, please contact your local Service Force Centre.

Hints for test centres

Testing in accordance with **EN 60704** must be carried out with appliance fully loaded and using the test programme (see "Washing programmes" chart).

Test in accordance with **EN 50242** must be carried out when the salt dispenser and rinse aid container have been filled with salt and rinse aid respectively and using the test programme (see "Washing programmes" chart).

Load:	12 standard place settings
Rinse aid setting:	position 4 (Type III)
Detergent dosage :	5 g + 25 g (Type B)



Arrangement upper basket

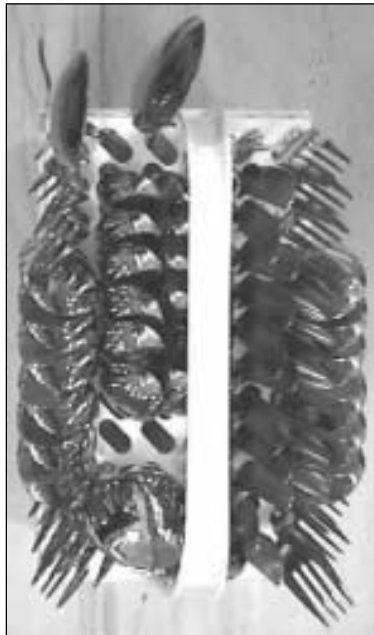

Arrangement cutlery basket



Arrangement lower basket

 **The Electrolux Group. The World's No.1 choice.**

The Electrolux Group is the world's largest producer of powered appliances for kitchen, cleaning and outdoor use. More than 55 million Electrolux Group products (such as refrigerators, cookers, vacuum cleaners, chain saws and lawn mowers) are sold each year to a value of approx. 14 billion USD in more than 150 countries around the world.

