

Your questions answered

- Q. Where can I fit *MagnaClean Micro*?
- A. *MagnaClean Micro* can be fitted anywhere on the main circuit. In order to achieve the best protection for the boiler, it is recommended that *MagnaClean Micro* is fitted between the last radiator and the boiler. In determining a suitable location for installation, it is important to ensure you allow adequate access for servicing.
- Q. Which connection on the *MagnaClean Micro* canister is the flow and which is the return?
- A. The bottom inlet is the flow, with the arrow pointing into the canister. The top is the return with the arrow pointing away from the canister. There is no flow restriction.
- Q. Can I fit *MagnaClean Micro* horizontally?
- A. *MagnaClean Micro* is designed to be fitted vertically. Each isolation valve can rotate through 360°. The copper pipe provided makes it possible to fit vertically on any pipe configuration. Please refer to the Installation and Servicing Instructions.
- Q. How often do I service *MagnaClean Micro*?
- A. Service *MagnaClean Micro* once a year in line with the annual boiler service. If *MagnaClean Micro* is installed on a larger system, the filter should be serviced twice in the first year to maintain optimum system protection.
- Q. Can I use chemicals with *MagnaClean Micro*?
- A. Yes, as part of ADEY's Best Practice™ approach, we recommend using our advanced chemical range for the maintenance and protection of central heating systems. Developed by the industry's only UKAS accredited laboratory, the MC range has been specially designed to enhance the performance of ADEY's award winning *MagnaClean* filter, offering exceptional system protection.
- Q. What is the lifespan of *MagnaClean Micro*?
- A. *MagnaClean Micro* has been designed to last for the lifetime of the boiler, normally ten years. It provides continuous protection and comes with a two year warranty. Registering your warranty is straight forward and can be done online at adey.com/warranty
- Q. How do I isolate the valves?
- A. Simply turn the valves to the marked OFF position using the small, black spanner provided. The valves rotate 360 degrees in either direction.
IMPORTANT: Remember to switch off the electrical supply to the boiler when servicing *MagnaClean Micro*.
- Q. I have a pacemaker, will *MagnaClean Micro* affect me?
- A. As with all magnetic products, if you have a pacemaker, caution should be taken when handling *MagnaClean Micro* at all times. When *MagnaClean Micro* is installed, the magnetic field outside the canister is approximately one tenth of an average fridge magnet.
- Q. How do I install *MagnaClean Micro* on plastic pipework?
- A. *MagnaClean Micro* has been designed to be used with any pipework. When installing on plastic pipework we would suggest converting to copper pipes allowing 200mm on each side and pipe clipping into place.

MagnaClean[®]
Micro

MagnaClean[®]
Micro

MagnaClean[®]
Micro

Installation and servicing instructions

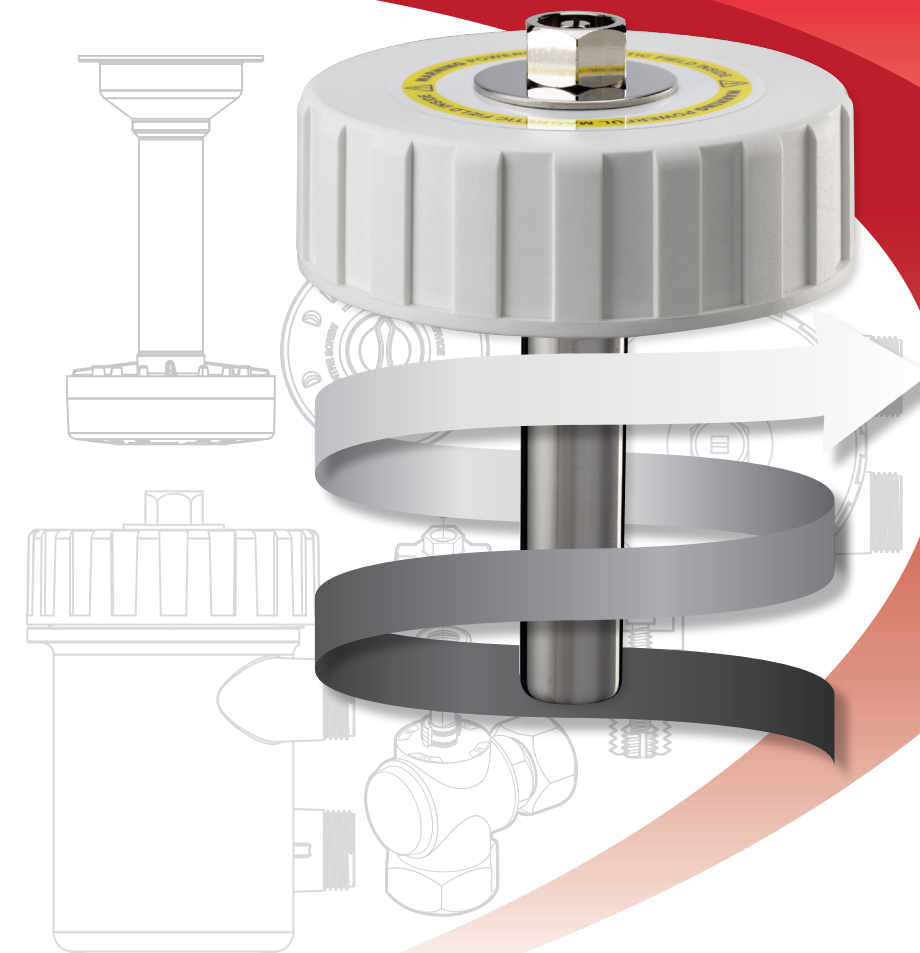

IMPORTANT

Always follow the Standard Electrical Best Practice guidelines when installing *MagnaClean Micro*.

A copy of these guidelines can be found at www.hse.gov.uk/electricity.

The bottom inlet is the flow, with the arrow pointing into the canister. The top is the return with the arrow pointing away from the canister. There is no flow restriction.

Following installation, don't forget to register for your two-year ADEY warranty. Visit adey.com/warranty

ADEY[®]

Telephone: 01242 546717 Email: info@adey.com
adey.com



Produced from recycled material

ADEY[®]

M07642

M1-INSL

Installation

MagnaClean® Micro has been developed to deliver effective central heating system protection against the damaging effects of black iron oxide. It is designed to remove magnetic and non-magnetic debris and is suitable for smaller domestic central heating systems, especially where space is limited.

The filter can be fitted anywhere on the main circuit. However, in order to achieve the best protection for the boiler, it is recommended that *MagnaClean Micro* is fitted after the last radiator and before the boiler.

In determining a suitable location, it is important to allow adequate access for servicing.

The following instructions are designed to assist engineers in the safe and effective installation and servicing of *MagnaClean Micro* and should be followed at all times. ADEY recommends using the powder-free vinyl gloves provided.

Any queries should be directed to your supervisor or ADEY direct on **01242 546717**.

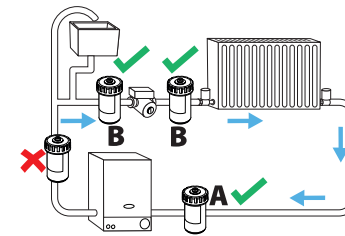

Open vented system

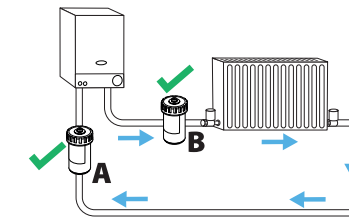

Combi/Sealed system

In both diagrams, position **A** is best practice while **B** is suitable.

N.B. We firmly recommend *MagnaClean Micro* is installed and serviced by a qualified heating engineer.

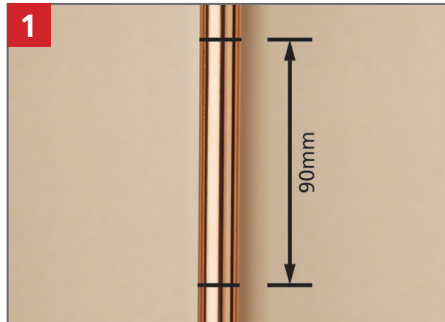

1 Drain the central heating system or plug-off feed and expansion tank and release the system pressure. Measure and mark a 90mm section when making the connections with elbows supplied, as shown in step 3 below. When installing below a boiler or other object, allow 170mm clearance from the top of the canister to beneath the object, to enable the lid assembly to be removed when servicing.

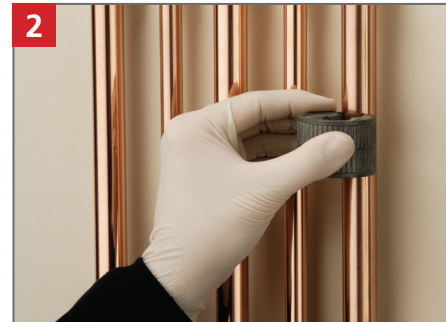

2 Using a suitable cutter, carefully remove the marked section of pipe work to create the correct opening.

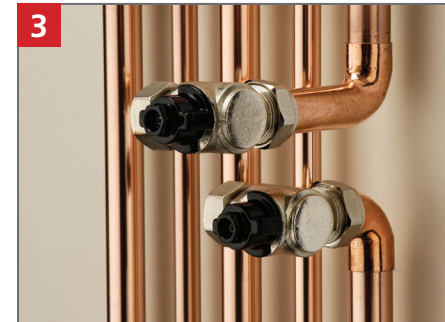

3 Prepare the pipe and fittings accordingly. Lubricate the olives and assemble the valves on the pipe. Hand tighten.



4 Loosely secure the *MagnaClean Micro* canister to the valves, following the flow direction indicated on the canister. Grip the canister and tighten the compression fittings being careful not to over tighten.



5 Loosen off the valve flange nuts and insert the rubber washers provided. Thoroughly tighten the flange nuts. Do not over tighten. Refill the heating system.



6 Run the central heating system while checking for leaks. Attach the completed self-adhesive *MagnaClean* label to the boiler. Always service the filter before leaving the premises. The lid and valve spanner can be left with the customer.

Servicing



1 Important – Before commencing any servicing work, turn off electrical supply to the boiler. Ensure the water is not too hot to undertake work on the system. Turn off both isolation valves to the marked OFF position. Loosen the air vent to release internal pressure. When venting, protect the surface below the canister with a dust sheet or container to capture any drops of water.



2 Using the *MagnaClean Micro* lid spanner, carefully unscrew the lid.



3 Remove the complete lid assembly from the *MagnaClean Micro*. Turn the lid assembly upside down in order that the underside of the lid acts as a drip tray.



4 Wrap paper towelling around the build-up of sludge on the plastic sheath. Place lid assembly over a bucket and remove the plastic sheath from the magnet, remove the sludge then rinse clean.

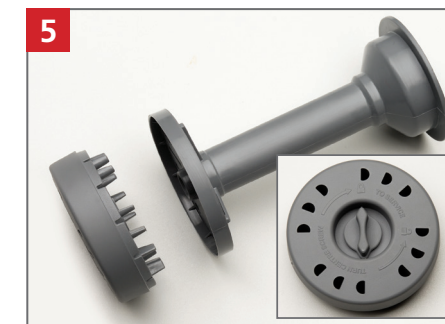

5 Unlock the bayonet screw on the base of the sheath and remove the debris collector. Rinse until all the non magnetic debris has been removed. Replace and lock the bayonet screw onto the sheath and place the sheath into the canister. Insert the magnet lid assembly and tighten until sealed.



6 Open the isolation valves to the marked ON position and vent/bleed through the Pro-Fill air vent. Protect the surface below the canister with a dust sheet or container to capture any drops of water. Run the central heating system while checking for leaks. Repeat steps 1 - 6 if required. Ensure the filter is thoroughly clean before leaving the premises.