



User Manual

USER MANUAL

Tumble Dryer

ZDC8202P

ZANUSSI

Contents

Safety information.....	2	Before First Use.....	8
Safety instructions.....	3	Daily Use.....	8
Product Description.....	4	Hints and tips.....	9
Control Panel.....	5	Care and cleaning.....	9
Programme table.....	5	Troubleshooting.....	11
Options.....	6	Technical Data.....	12
Settings.....	7		

Subject to change without notice.

Safety information

Before the installation and use of the appliance, carefully read the supplied instructions. The manufacturer is not responsible if an incorrect installation and use causes injuries and damages. Always keep the instructions with the appliance for future reference.

General Safety

- Do not change the specification of this appliance.
- If the tumble dryer is put on top of a washing machine, use the stacking kit. The stacking kit, available from your authorized vendor, can be used only with the appliance specified in the instructions, supplied with the accessory. Read it carefully before installation (Refer to the Installation leaflet).
- The appliance can be installed as freestanding or below the kitchen counter with correct space (Refer to the Installation leaflet).
- Do not install the appliance behind a lockable door, a sliding door or a door with a hinge on the opposite side, where the appliance door can not be fully opened.
- The ventilation openings in the base (if applicable) must not be obstructed by a carpet.
- Connect the mains plug to the mains socket only at the end of the installation. Make sure that there is access to the mains plug after the installation.
- Ensure you have good ventilation in the installation room to avoid the back flow of gases into the room from appliances burning other fuels, including open fires.
- Exhaust air must not be discharged into a flue which is used for exhausting fumes from appliances burning gas or other fuels. (if applicable)
- If the supply cord is damaged, it must be replaced by the manufacturer, its Authorised Service Centre or similarly qualified persons in order to avoid a hazard.
- **Obey the maximum load volume of 8kg (refer to the “Programme chart” chapter).**
 - Do not use the appliance if industrial chemicals have been used for cleaning.
 - Wipe away lint that has accumulated around the appliance.
 - Do not run the appliance without a filter. Clean the lint filter before or after each use.

- Do not dry unwashed items in the tumble dryer.
- Items that have been soiled with substances such as cooking oil, acetone, alcohol, petrol, kerosene, spot removers, turpentine, waxes and wax removers should be washed in hot water with an extra amount of detergent before being dried in the tumble dryer.
- Items such as foam rubber (latex foam), shower caps, waterproof textiles, rubber backed articles and clothes or pillows fitted with foam rubber pads should not be dried in the tumble dryer.
- Fabric softeners, or similar products, should be used as specified by the fabric softener instructions.
- Remove all objects from pockets such as lighters and matches.
- Never stop a tumble dryer before the end of the drying cycle unless all items are quickly removed and spread out so that the heat is dissipated.
- The final part of a tumble dryer cycle occurs without heat (cool down cycle) to ensure that the items are left at a temperature that ensures that the items will not be damaged.
- Before maintenance, deactivate the appliance and disconnect the mains plug from the mains socket.

Children and vulnerable people safety



WARNING!

Risk of suffocation, injury or permanent disability.

- This appliance can be used by children aged from 8 years and above and persons with reduced physical, sensory or mental capabilities or lack of experience and knowledge if they have been given supervision or instruction concerning use of the appliance in a safe way and understand the hazards involved.
- Do not let children play with the appliance.
- Children of less than 3 years should be kept away unless continuously supervised.
- Keep all packaging away from children.
- Keep all detergents away from children.
- Keep children and pets away from the appliance door when it is open.
- If the appliance has a child safety device, we recommend you activate it.
- Cleaning and user maintenance shall not be made by children without supervision.

Safety instructions

Installation

- Remove all the packaging.
- Do not install or use a damaged appliance.
- Obey the installation instruction supplied with the appliance.
- Always be careful when you move the appliance because it is heavy. Always wear safety gloves.
- Do not install or use the appliance where the temperature is less than 5°C or higher than 35°C.
- Make sure that the floor where you install the appliance is flat, stable, heat resistant and clean.
- Make sure that there is air circulation between the appliance and the floor.
- Always move the appliance vertically.
- The rear surface of the appliance must be put against the wall.

- When the appliance is put in its permanent position, check if it is fully level with the aid of a spirit level. If it is not, adjust the feet until it is.

Electrical connection

Risk of fire and electrical shock.

- The appliance must be earthed.
- Make sure that the electrical information on the rating plate agrees with the power supply. If not, contact an electrician.
- Always use a correctly installed shockproof socket.
- Do not use multi-plug adapters and extension cables.
- Do not pull the mains cable to disconnect the appliance. Always pull the mains plug.
- Do not touch the mains cable or the mains plug with wet hands.

- Only for UK and Ireland. The appliance has a 13 amp mains plug. If it is necessary to change the fuse in the mains plug, use a 13 amp ASTA (BS 1362) fuse.
- This appliance complies with the E.E.C. Directives.

Use

Risk of injury, electrical shock, fire, burns or damage to the appliance.

- Use this appliance in a household only.
- Do not dry the damaged items which contain padding or fillings.
- Only dry fabrics which are applicable to dry in the tumble dryer. Follow the instructions on the fabric label.
- If you have washed your laundry with a stain remover start an extra rinse cycle before you start the dryer.
- Do not drink or prepare food with the condensed water/distilled water. It can cause health problems to people and pets.

Product Description

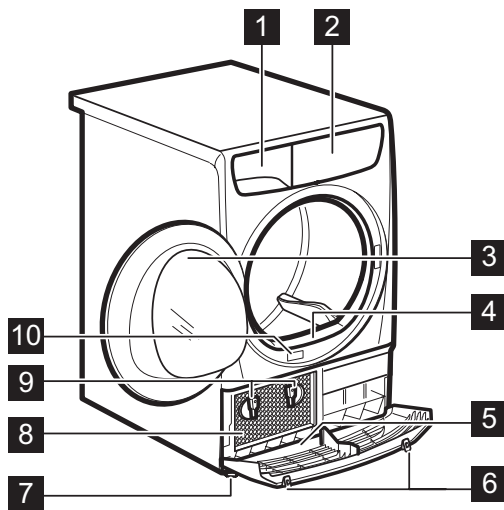

The load door can be installed by the user in the opposite side. It can help to easily put and remove the laundry or if

- Do not sit or stand on the open door.
- Do not dry dripping wet clothes in the tumble dryer.

Care and cleaning

Risk of injury or damage to the appliance.

- Do not use water spray and steam to clean the appliance.
- Clean the appliance with a moist soft cloth. Only use neutral detergents. Do not use abrasive products, abrasive cleaning pads, solvents or metal objects.

Disposal

Risk of injury or suffocation.

- Disconnect the appliance from the mains supply.
- Cut off the mains cable and discard it.
- Remove the door catch to prevent children and pets to get closed in the appliance.

- 1 Water container
- 2 Control panel
- 3 Appliance door
- 4 Primary Filter
- 5 Bottom cover with the airflow slots



WARNING!

Do not put any object on the bottom cover

- 6 Buttons to open the bottom cover
- 7 Adjustable feet
- 8 Condenser door
- 9 Locks for condenser door
- 10 Rating plate

there is a limit to install the appliance (see separate leaflet).

Control Panel

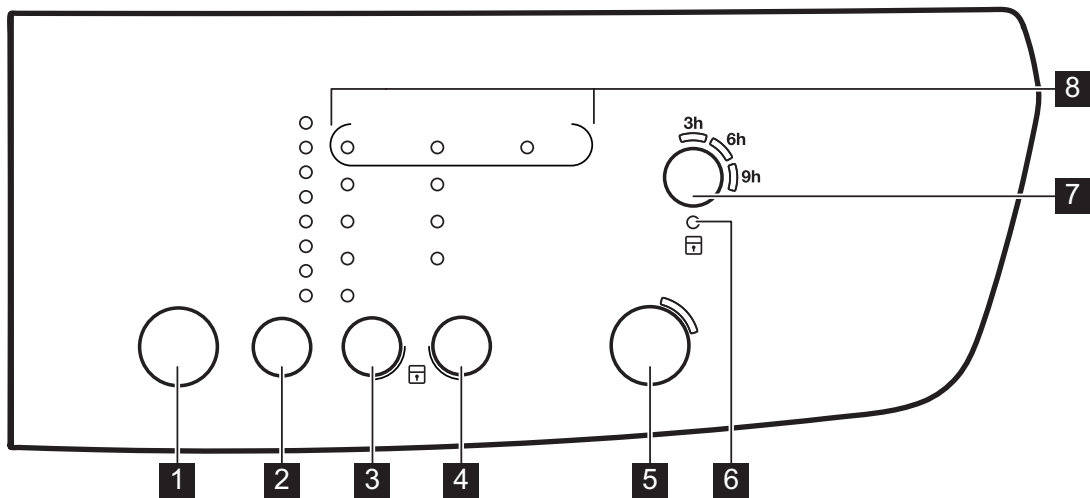



- 1** On / Off button
- 2** Programme selection touchpad **P**
- 3** Dryness selection touchpad
- 4** Options selection touchpad
- 5** Start/Pause touchpad
- 6** Child lock indicator
- 7** Delay touchpad

- 8** Indicators: Filter , Condenser , Tank

Touch the touchpads with your finger in the area with the symbol or name of the option. Do not wear gloves when you operate with the control panel. Make sure that the control panel is always clean and dry.

Programme table

Programmes	Type of load	Load (max.) ¹⁾ / Fabric mark
Cottons	Drying level: Extra Dry, Strong Dry, Cupboard Dry ²⁾³⁾ , Iron Dry ³⁾	8kg/
Synthetics	Drying level: Extra Dry, Cupboard Dry ³⁾ , Iron Dry	3,5
Mix	Cotton and synthetic fabrics. Low temperature programme. Delicate programme with warm air.	3kg/
Easy Iron	Easy care fabrics for which a minimum of ironing is necessary. The drying results can be different from one type of fabric to the other. Shake the items before you put them in the appliance. When the programme is completed, Immediately remove the items and put them on a hanger.	1kg (or 5 shirts)/

Programmes	Type of load	Load (max.) ¹⁾ / Fabric mark
Wool ⁴⁾	Wool fabrics. Gentle drying washable woollens. Remove immediately the items when the programme is completed.  WOOLMARK APPAREL CARE	1kg
Duvet	To dry one or two duvet and pillows (with feather, down or synthetic fillings).	3kg/ 
Refresh	Refreshing a textiles that were in storage.	1kg
Time 30 min	Time programme to dry individual items of laundry.	8kg/ 

1) The maximum weight refers to dry items.

2) The  Cottons Cupboard Dry programme is the "Standard cotton programme" and it is suitable to dry normal wet cotton laundry and it is the most efficient programme in terms of energy consumption for drying wet cotton laundry.





3) **For test institutes only:** Standard programmes for tests are specified in the EN 61121 document.

4) The wool drying cycle of this machine has been approved by The **Woolmark** Company for the drying of machine washable wool products provided that the products are washed and dried according to the instructions on the garment label and those issued by the manufacturer of this machine. **M1221**. In UK, Eire, Hong Kong and India the **Woolmark** symbol is a certification trademark.

Options

Dryness

This function helps to get the laundry more dried. There are 4 possible selections:

-  Extra Dry
-  Strong Dry (for Cotton only)
-  Cupboard Dry
-  Iron Dry

Antcrease 90 min

Extends of 60 minutes the standard antcrease phase (30 minutes) at the end of the drying

cycle. This function prevents the laundry from creases. The laundry can be removed during the antcrease phase.

Time 60 min

Extends of 30 minutes the Time 30 min programme.

Delicate

With this option you can set a delicate drying programme that has a low temperature. Use this option with a fabrics that have the symbol  on the fabric label (e.g. acrylic, viscose).

Options table

Programmes	☀				☑		
	☀	☀	☀	☀	Anti-crease 90 min	Time 60 min	Delicate
Cottons	■	■	■	■	■		■
Synthetics	■		■	■	■		■
Mix			■		■		
Easy Iron				■			■
Wool			■				■
Duvet			■				■
Refresh					■		
Time 30 min					■	■	■

Settings

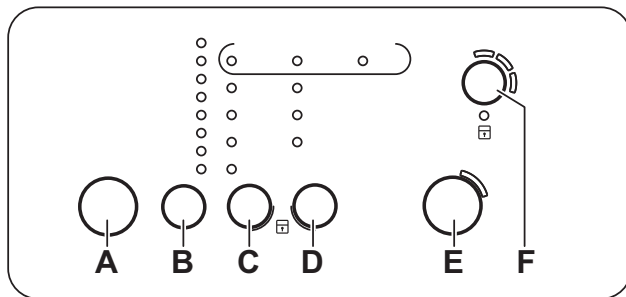

- A)** On / Off button ①
- B)** Programme selection touchpad **P**
- C)** Dryness selection touchpad ☀
- D)** Options selection touchpad ☑
- E)** Start/Pause touchpad ▶||
- F)** Delay touchpad ⌚

Child lock function

This option prevents children to play with the appliance while a programme operates. The programme knob and the touchpads are locked.

Only the on/off button is unlocked.

Activating the child lock option:

- 1.** Press the on/off button to activate the appliance.
- 2.** Wait approximately 8 seconds.
- 3.** Press and hold touchpads **(C)** and **(D)** at the same time. The child lock indicator comes on.

The child lock indicator comes on.

- i** It is possible to deactivate the child lock option while a programme operates. Press and hold the same touchpads until the child lock indicator goes off.

Buzzer on/off



To deactivate or activate the acoustic signals, press and hold for approximately 2 seconds touchpads **(B)** and **(C)** at the same time.

Adjustment of the remaining laundry moisture degree

To change the default degree of the remaining moisture of the laundry:

1. Press the on/off button to activate the appliance.
2. Wait approximately 8 seconds.
3. Press and hold buttons **(B)** and **(D)** at the same time.

One of the these indicators comes on:

- Filter  - the maximum dry laundry
- Condenser  - the more dry laundry
- Tank  - the standard dry laundry

4. Press the button **(E)** again and again until the indicator of the correct level comes on.
5. To confirm the adjustment, press and hold buttons **(B)** and **(D)** at the same time for approximately 2 seconds.

Before First Use

Before you use the appliance for the first time do these operations:

- Clean the tumble dryer drum with a moist cloth.

- Start a short programme (e.g. 30 minutes) with moist laundry.

Daily Use

Start a programme without delay start

1. Prepare the laundry and load the appliance. Make sure that when you close the door, the laundry does not catch between the appliance door and the rubber seal.
2. Press the on/off button to activate the appliance.
3. Set the correct programme and options for the type of load.
4. Press the Start/Pause touchpad.
The programme starts.

Starting the programme with delay start

1. Set the correct programme and options for the type of load.
2. Press the delay start button again and again as necessary.



You can delay the start of a programme by 3, 6 or 9 hours.

3. Press the Start/Pause button.
The LEDs (9H, 6H, 3H) change on each 3 hours.

Change a programme

1. Press the on/off button to deactivate appliance
2. Press the on/off button to activate the appliance.
3. Set the programme.

At the end of the programme

When the programme is completed:

- An intermittent acoustic signal operates.
- The indicators Filter and Condenser comes on.
- The Start/Pause indicator is on.

The appliance continues to operate with the crease guard phase for approximately other 30 minutes.

The crease guard phase removes creases from your laundry.

You can remove the laundry before the crease guard phase is completed. We recommend, for better results, that you remove the laundry when the phase is almost completed or completed.

When the crease guard phase is completed:

- The indicators Filter and Condenser comes on.
- Start/Pause indicator goes off.

1. Press the on/off button to deactivate the appliance.
2. Open the appliance door.
3. Remove the laundry.
4. Close the appliance door.

Always clean the filter and empty the water container when a programme is completed.

Stand-by function

To decrease the energy consumption, this function automatically deactivates the appliance:





- After 5 minutes if you do not start the programme.

- After 5 minutes from the end of the programme.

Hints and tips

Preparing the laundry

- Close the zippers.
 - Close the fasteners of the duvet covers.
 - Do not keep ties or ribbons loose (e.g. apron ribbons). Tie them before you start a programme.
 - Remove all items from the pockets.
 - If an item has the internal layer made of cotton, turn it inside out. Make sure that the cotton layer is always external
 - We recommend that you set the correct programme applicable for the type of fabrics that are in the appliance.
- Do not put fabrics with strong colours together with fabrics with light colours. Strong colours can bleed.
 - Use an applicable programme for cotton jersey and knitwear to prevent the items to shrink.
 - Make sure that the laundry weight is not more than the maximum weight that is in the programme table.
 - Dry only the laundry that is applicable for tumble dryer. Refer to the fabric label on the items.

Fabric label	Description
	Laundry that is applicable for tumble dryer.
	Laundry that is applicable for tumble dryer. Set the programme with standard temperature.
	Laundry that is applicable for tumble dryer. Set the programme with low temperature.
	Laundry that is not applicable for tumble dryer.

Care and cleaning

Cleaning the filter

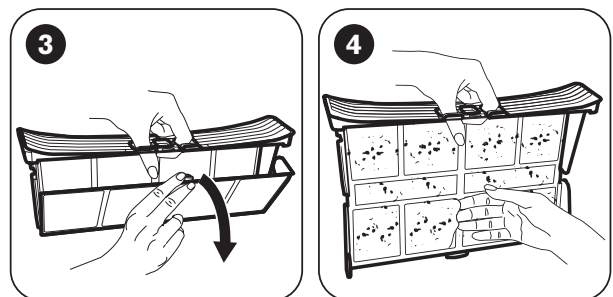
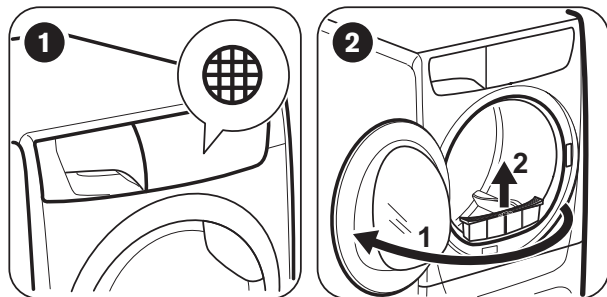

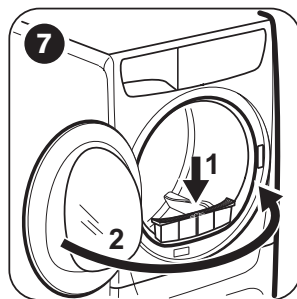
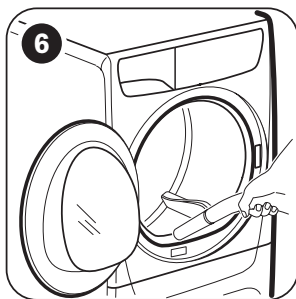
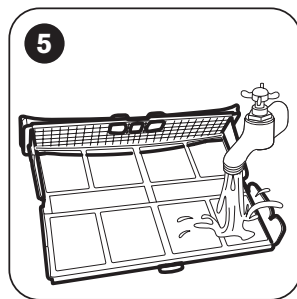

Draining the water container

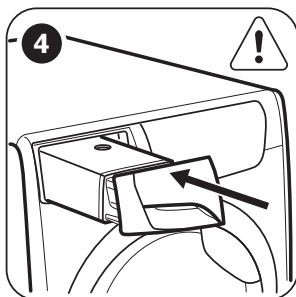
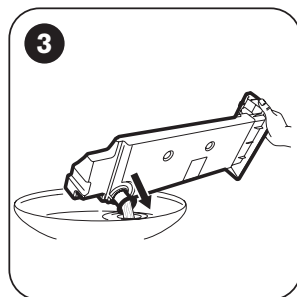
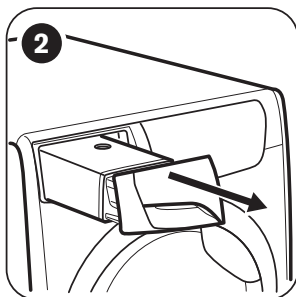
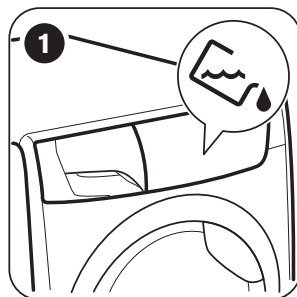

You can use the water from the water container as an alternative to distilled water (e.g. for steam ironing). Before you use the water, remove dirt residues with a filter.

Cleaning the condenser

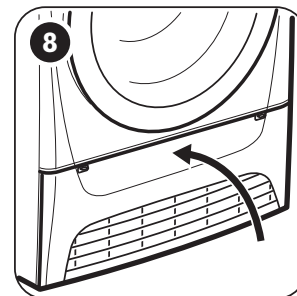
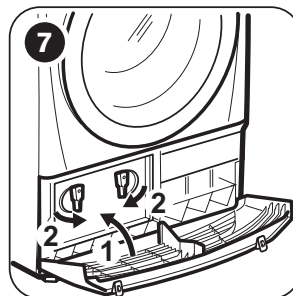
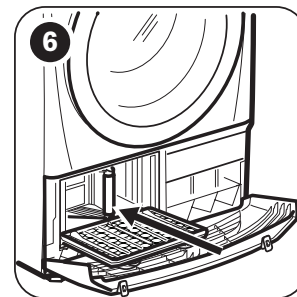
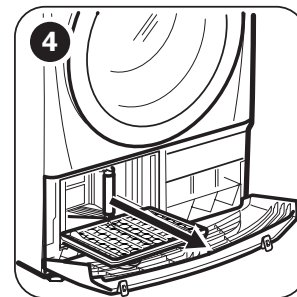
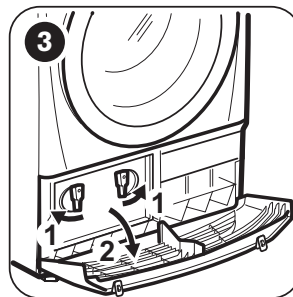
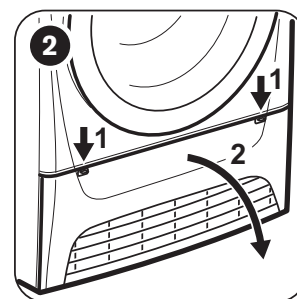
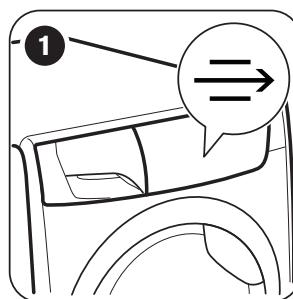

Cleaning the drum



WARNING!

Disconnect the appliance before you clean it.

Use a standard neutral soap detergent to clean the inner surface of the drum and drum ribs. Dry the cleaned surfaces with a soft cloth.



CAUTION!

Do not use abrasive materials or steel wool to clean the drum.

Cleaning the control panel and housing

Use a standard neutral soap detergent to clean the control panel and housing.

Use a moist cloth to clean. Dry the cleaned surfaces with a soft cloth.



CAUTION!

Do not use furniture cleaning agents or cleaning agents which can cause corrosion to clean the appliance.

Cleaning the airflow slots

Use a vacuum cleaner to remove the fluff from the airflow slots.

Troubleshooting

Problem	Possible solution
You cannot activate the appliance.	Make sure that the mains plug is connected to the mains socket. Check fuse in fuse box (domestic installation).
The programme does not start.	Press Start/Pause. Make sure that the appliance door is closed.
The appliance door does not close.	Make sure that the installation of the filter is correct. Make sure that the laundry does not catch between the appliance door and the rubber seal.
The appliance stops during operation.	Make sure that the water container is empty. Press Start/Pause to start the programme again.
Drying cycle lasts an unusually long time. ¹⁾	Make sure that the weight of the laundry is applicable to the duration of the programme. Make sure that the filter is clean. The laundry is too wet. Spin the laundry in the washing machine again. Make sure that the room temperature is not too warm.
Drying cycle ends shortly after programme starts.	Set the Time Drying or the Extra Dry programme.

¹⁾ After maximum 5 hours, the programme ends automatically

If the drying results are not satisfactory

- The set programme was incorrect.
- The filter is clogged.
- The condenser is clogged.
- There was too much laundry in the appliance.
- The drum is dirty.
- Incorrect setting of the conductivity sensor.
- The airflow slots are clogged.

Technical Data

Height x Width x Depth	850 x 600 x 600 mm (maximal 680 mm)
Max. depth with the appliance door open	1090 mm
Max. width with the appliance door open	950 mm
Adjustable height	850 mm (+ 15 mm - feet regulation)
Drum volume	118 l
Maximum load volume	8 kg
Voltage	230-240 V
Frequency	50 Hz
Necessary fuse	13 A
Total power	2800 W
Energy efficiency class	B
Energy consumption ¹⁾	4,82 kWh
Annual energy consumption ²⁾	560 kWh
Left—on mode power absorption	0,55 W
Off mode power absorption	0,55 W
Type of use	Household
Permitted ambient temperature	+ 5°C to + 35°C
Level of protection against ingress of solid particles and moisture ensured by the protective cover, except where the low voltage equipment has no protection against moisture	

1) With reference to EN 61121. 8kg of cotton centrifuged at 1000 rpm.



2) Energy consumption per year in kWh, based on 160 drying cycles of the standard cotton programme at full and partial load, and the consumption of the low-power modes. Actual energy consumption per cycle will depend on how the appliance is used (REGULATION (EU) No 392/2012).

Consumption Data

Programme	Spun at / residual humidity	Drying time	Energy consumption
Cottons 8 kg			
Cupboard Dry	1400 rpm / 50%	123 min.	4,23 kWh
	1000 rpm / 60%	138 min.	4,82 kWh
Iron Dry	1400 rpm / 50%	107 min.	3,46 kWh
	1000 rpm / 60%	118 min.	3,95 kWh

Programme	Spun at / residual humidity	Drying time	Energy consumption
Synthetics 3,5 kg			
Cupboard Dry	1200 rpm / 40%	50 min.	1,47 kWh
	800 rpm / 50%	57 min.	1,68 kWh

ENVIRONMENTAL CONCERNS

Recycle the materials with the symbol . Put the packaging in applicable containers to recycle it. Help protect the environment and human health and to recycle waste of electrical and electronic appliances. Do not dispose appliances marked with the symbol  with the household waste. Return the product to your local recycling facility or contact your municipal office.



www.zanussi.com/shop



136931290-A-142014