

Basic information about your Smoke Alarm

A Smoke Alarm is an early warning device. Used correctly it can give you and your family valuable extra time to escape.

Note:-

When the battery is first connected the Alarm may sound for 2-3 seconds - this is normal.
A Smoke Alarm does not prevent fires.
Install correctly, in the center of the ceiling if possible.
Test weekly.
Replace battery yearly or when it beeps once a minute.
Plan your escape route.
Proper protection may require more than one Smoke Alarm.
If you have any doubt or query about Smoke Alarms consult the supplier or your local Fire Brigade.
Nuisance alarms can be quickly silenced by fanning with a newspaper or similar to help remove smoke from the unit.

Locating your Smoke Alarm

Sufficient smoke must enter your Smoke Alarm before it will respond. Your Smoke Alarm needs to be within 10 paces (23 feet) of the fire to respond quickly. It also needs to be in a position where its alarm can be heard throughout your home, so it can wake you and your family in time for you all to escape. A single Smoke Alarm will give some protection if it is properly installed, but most homes will require two or more to ensure that a reliable early warning is given. For maximum protection you should put individual Smoke Alarms in all the rooms where fire is most likely to break out.

Your first Smoke Alarm should be located between the sleeping area and the most likely sources of fire (living room or kitchen for example). But it should not be more than 10 paces (seven metres) from the door to any room where a fire might start and block your escape from the house.

(a) Single Storey Dwelling.

If your Home is on one level (a bungalow or mobile home for example) you should put your first Smoke Alarm in a corridor or hallway between the sleeping and living areas. Place it as near to the living area as possible, but make sure you can hear it loudly enough to wake you in the bedroom. (for example, see figure 1)

If your bungalow is very large and the corridor or hallway is more than say 22 paces (15 metres) long, one Smoke Alarm will not be sufficient. This is because no matter where it is located it will be more than 7.5 metres from potential fires.

In houses with more than one sleeping area, Smoke Alarms should be placed between each sleeping area and the living area (for example, see figure 2).

2

Figure 1: Single Storey Dwelling

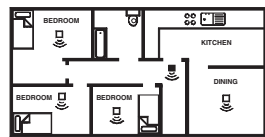

Figure 2: Single Storey Dwelling with separate sleeping areas

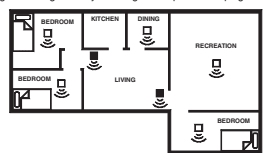

Figure 3: Two Storey Dwelling



Recommended protection, Figures 1, 2 & 3

- Minimum protection each storey each sleeping area every 7.5 metres (25ft) of hallways and rooms
- Maximum protection All rooms (except bathrooms & kitchens)

(b) Multi Storey Dwellings.

If your home is on more than one level you will require a smoke alarm on each storey (see figure 3).

3

This is because an upstairs smoke alarm is unlikely to detect a fire on lower floors in sufficient time to ensure an adequate escape.

(c) Maximum Protection.

For maximum protection you should put individual Smoke Alarms in all the rooms where fire is most likely to break out (apart from the locations to avoid, mentioned on page 5). The living room is the most likely place for a fire to start at night, followed by the kitchen and then the dining room. You should also consider putting Smoke Alarms in any bedrooms where fires might occur, for instance, where there is an electrical appliance such as an electric blanket or heater, or where the occupant is a smoker. You could also consider putting Smoke Alarms in any rooms where the occupant is unable to respond very well to a fire starting in the room, such as an elderly or sick person or a very young child.

(d) Checking you can hear your Smoke Alarm.

With the Smoke Alarm sounding in its intended location, check you are able to hear it in each bedroom with the door closed, above the sound of your radio. The radio should be set to a reasonably loud conversation level. If you can't hear it over your radio the chances are that it wouldn't wake you.

If a Smoke Alarm is too far away for it to wake you, it is best to link it to another Smoke Alarm near the bedroom. The Interconnect Smoke Alarm

EI 100C is designed for this - when one alarm senses smoke, all connected alarms respond. (see page 9 for further details).

Positioning your Smoke Alarm

Figure 4: IDEAL IN CENTRE OF CEILING

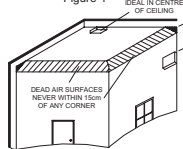
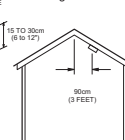

Figure 5



(a) Ceiling Mounting.

Hot smoke rises and spreads out, so a central ceiling position is the preferred location. The air is "dead" and does not move in corners, therefore Smoke Alarms must be mounted away from corners. Place the unit at least 30cm (12 inches) from any light fitting or decorative object which might obstruct smoke entering

4

the Smoke Alarm. Keep at least 15 cm (6 inches) away from walls and corners. See figure 4.

(b) Wall Mounting.

When a ceiling position is not practical (for example on a ceiling having exposed beams or joists, or built-in radiant heating) put the top edge of your Smoke Alarm between 15 and 30 cm (6 and 12 inches) below the ceiling. Keep at least 15cm (6 inches) from corners. (see figure 4).

(c) On a sloping Ceiling.

In areas with sloping or peaked ceilings install your Smoke Alarm 90 cm (3 feet) from the highest point measured horizontally (see figure 5), because "dead air" at the apex may prevent smoke from reaching the unit.

(d) Locations to Avoid.

Don't place your Smoke Alarm in any of the following areas:

Bathrooms, kitchens, shower rooms, garages or other rooms where the smoke alarm may be triggered by steam, condensation, normal smoke or fumes. Keep at least 6 metres (20 feet) away from sources of smoke - wall mounting if necessary.

Attics or other places where extremes of temperature may occur (below 4 C/34 F or above 40 C/104 F).

Near a decorative object, door, light fitting, window molding etc., that may prevent smoke from entering the Smoke Alarm. Surfaces that are normally warmer or colder than the rest of the room (for example attic hatches, uninsulated exterior walls etc). Temperature differences might stop smoke from reaching the unit.

Next to or directly above heaters or air conditioning vents, windows, wall vents etc. that can change the direction of air flow.

In very high or awkward areas where it may be difficult to reach the alarm (for testing, battery replacement etc).

(e) Nuisance/False Alarms.

If, when the alarm goes off, there is no sign of smoke heat or noise to indicate that there is a fire, you should get your family into a safe place, before you start investigating.

Check the house carefully in case there is a small fire smoldering somewhere.

Check whether there is some source of smoke or fumes, for example cooking fumes being drawn past the Smoke Alarm by an extractor.

If there are frequent nuisance/false alarms it may be necessary to re-locate the device away from the source of the fumes.

The Silencer Smoke Alarm EI 100S is designed for more difficult areas, as you can silence the alarm for 8 minutes. This gives time for smoke or fumes to clear, (see page 10 for more details).

5

Installing your Smoke Alarm

(a) Attaching to Ceiling or Wall.
(NB: for wiring the EI 100C Interconnect model see page 9)
The Smoke Alarm is battery operated and needs no wiring. (EI 100C excepted). Use figure 6 below, as a help in mounting.

Figure 6

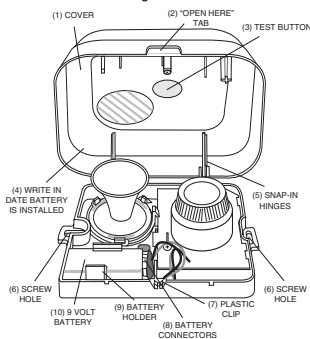

1. Pull Cover open at Tab (2). Remove Cover from Base by separating at rear Snap-in Hinges (5).
 2. Place the Base on ceiling or wall exactly where you want to mount the unit. With a pencil, mark the location of the Screw Holes (6).
 3. Taking care to avoid any electrical wiring in the ceiling or wall, drill a hole through the centers of the marked locations. Push the plastic Screw Anchors provided into the drilled holes. Screw in firmly.
- (b) Connecting the battery.**
With a pencil, write the date of Battery installation on the inside of the Cover to remind you when to replace the battery (4).
Lift Battery from Battery holder, and snap Battery Connectors to Battery. They fit together only one way (Figure 7).
Gently push Battery into Battery Holder (9).

To close the cover match up Snap-in Hinges (5) and gently press together until Base and Cover snap together.

6

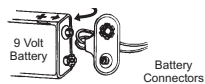

Figure 7

NOTE: You may hear a loud chirp when attaching the Battery Connectors to the Battery. N.B. The emergency light Smoke Alarm needs 2 batteries (see page 9 for details). Test the installed Smoke Alarm - see section 5(a) below.

(c) Battery Missing Indicator

Some models will be fitted with a warning flag which pops up when the battery is removed. This prevents the cover from closing when there is no battery in the unit. When the battery is being installed or changed, this flag must be held down while gently pushing the Battery into the Battery Holder. (Figure 8).

Figure 8

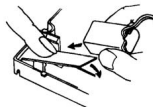

Looking after your Smoke Alarm

(a) Testing your Smoke Alarm

It is recommended that you test your Smoke Alarm once a week to be sure the unit is working. It will also help you and your family to become familiar with the sound of the Alarm.

When you press the Test Button it simulates the effect of smoke during a real fire. So, there is no need to test the Alarm with smoke.

Press and hold the Test Button until the Alarm sounds (it may take up to 10 seconds), (Figure 9). The alarm will stop sounding shortly after the Button is released. If the alarm fails to sound, follow this checklist.

1. Check Battery Connectors to be sure they are firmly snapped to the Battery.

Figure 9



7

2. Replace the Battery. (Check the date marked on the Cover when you last replaced the Battery).
3. Refer to "Cleaning Your Smoke Alarm" 5 (c) below.

WARNING: DO NOT TEST WITH FLAME.

This can set fire to the Alarm and damage the house.

We do not recommend testing with smoke or heat as the results can be misleading unless special apparatus is used.

(b) Replacing the Battery(ies)

Test the alarm for correct operation using the test button whenever the battery(ies) is/are replaced.

A fresh Battery should last about one year. When Battery power is low and replacement is necessary, the Alarm will "beep" about once per minute for at least 30 days. The battery must then be replaced. Replace battery if the alarm does not sound when the Test Button is pressed. For maximum reliability, replace battery at least once a year.

On Smoke Alarms with a Power Indicator flashing light, if the light ceases flashing replace the battery. Be sure to replace the Battery as soon as possible to ensure proper operation and to avoid a leaking Battery. Leakage could cause damage to the Alarm, furniture, and carpeting.

For replacement batteries, refer to the information inside Smoke Alarm Cover.

WARNING: Use of any other battery may be detrimental to the operation of the Smoke Alarm.

(c) Cleaning your Smoke Alarm.

Clean your Smoke Alarm regularly. Use a soft bristle brush or the brush attachment of your vacuum cleaner to remove dust from the sides and cover slots where the smoke enters. Keep Cover closed while cleaning. Do not vacuum or brush inside the Smoke Alarm. To clean the Cover, remove it completely and use only mild soap and water. Dry cover thoroughly before replacing it. **WARNING:** Do not paint your Smoke Alarm.

Other than the maintenance and cleaning described in this leaflet, no other customer servicing of this product is required. Repairs, when needed, must be performed by the manufacturer.

Smoke Alarms with Additional Features

A range of Smoke Alarms are produced which are optimized for different locations and/or uses.

(a) Power Indicator Light.

A number of Smoke Alarms have a Power Indicator Light which flashes once a minute through the test button to show the Smoke Alarm is powered. Replace the battery if the flashing

8

stops.

(b) Emergency Light Smoke Alarm EI 100L

When the smoke alarm senses smoke, the bright emergency light turns on to help identify and light the escape route. The Smoke Alarm should therefore be located where it will light the escape route - in a hallway, above a stairs or near the exit.

Connection and Replacement of Batteries.

The smoke alarm uses two different types of standard 9 volt batteries, an alkaline battery and a general purpose battery.

1. Connect an alkaline battery (use only Duracell MN1604 or Eveready 522) to the **blue** battery connector to power the light. This battery when fresh will normally last 1 year in the stand by mode and provide over 15 minutes of light when in alarm. The Smoke Alarm is normally shipped with the alkaline battery connected to facilitate the customer - this does not deplete the battery.

2. Connect the general purpose battery to the **black** battery connector to power the smoke alarm. This battery when fresh will normally last over one year before it needs replacement.

Replace both batteries when the smoke alarm gives a short chirp every minute or when the light looks dim during a button test.

Use only batteries specified on the Smoke Alarm, the use of other batteries could have a detrimental effect on smoke alarm operation or light output.

Bulb Replacement.

The bulb is designed to operate for 15 hours continuous operation and should not need replacement during the life of the product. If, when the button is pressed with two fresh batteries, only the horn sounds, the bulb must be replaced.

The bulb can be removed by pulling it straight out (do not twist). Replace with a bulb type GE 149.

If you have difficulty in finding a suitable replacement contact "Consumer Assistance" at the nearest address given in this booklet, or on the Smoke Alarm.

Use only the bulb specified. Use of any different bulb could have a detrimental effect on light or Smoke Alarm performance.

(c) Interconnect Model EI 100C

A maximum of 12 interconnect EI 100C or EI 105C Smoke Alarms may be wired together such that when one unit senses smoke all other units sound a warning. This helps ensure smoke alarms will be heard.

9

Warning: Do not interconnect to any other Smoke Alarms.

A maximum of 250 metres (820ft) of 18 AWG (0.82mm) wire can be used, (maximum resistance between detectors 50 ohm). The units are interconnected by wiring all the terminals marked 1 together, and all the terminals marked 2 together, as shown in Figure 10. An opening should be made in the label covering the wiring hole in the base, and the wires routed into the unit as shown. Note that the wiring inside the unit must be kept clear of the test button contacts, but must not impede the air flow. Drafts from wiring openings, conduit, or mounting boxes/holes, may blow smoke away from the sensing chamber, making it insensitive. It is essential that all such openings be closed by silicone sealant or similar.

You must press in and hold the test button for at least 4 to 5 seconds, as there is a time delay on some units.

Figure 10

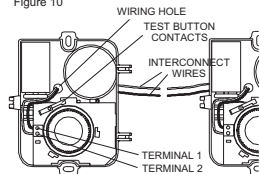

After wiring together the Interconnect Smoke Alarms, test the first unit by pressing the button. All the detectors should alarm and the test button on the first unit will flash about once every 2 seconds. Check all the other units similarly.

These Smoke Alarms should be interconnected only within the confines of a single family living unit. If they are connected between different units there may be excessive nuisance alarms. Everybody may not be aware that they are being tested or that it is a nuisance alarm caused by cooking etc.

(d) Silencer Smoke Alarm EI 100S

This model has a special false alarm silencer feature to help you control nuisance false alarms.

1. To cancel a false alarm, press the Silencer Button located on the lower right-hand corner. The Alarm will automatically switch to a reduced sensitivity condition. This condition allows unwanted alarms to be silenced for a period of approximately 8 minutes. The unit will continue to "chirp" about every 40 seconds during this time to let you know the unit has been silenced.

2. The unit will reset to normal sensitivity at the end of the silenced period. If additional silenced time is required, simply push the Silencer Button again.

3. To quickly return to normal non-silenced operation, simply push the Test Button; the alarm will sound briefly and return to its normal, sensitive alarm mode.

4. After installation, your Smoke Alarm may chirp approximately every 40 seconds. This indicates it is in the Silencer mode. To put it into normal operating mode, push and hold Test Button until alarm sounds.

5. If the cause of the alarm is not clear, it should be assumed that it is due to an actual fire and the dwelling should be evacuated immediately.

If usage/layout is such that there are an unacceptable level of nuisance alarms, even with the Silencer Smoke Alarm, re-locate the Smoke Alarm farther away from the kitchen where it will be less affected by cooking fumes.

The Silencer Smoke Alarm model number EI 100S is also suitable for use in touring caravans.

Important Safeguards

When using household protective devices, basic safety precautions should always be followed, including those listed below:

Please read all instructions. Rehearse emergency escape plans so everyone at home knows what to do in case the alarm sounds. For replacement batteries, refer to the information inside smoke alarm.

NOTE: Constant exposure to high or freezing temperatures or high humidity may reduce the life of the batteries.

Do not disconnect battery to stop alarm sounding. (Fanning vigorously with a newspaper or similar will remove nuisance smoke from the Smoke Alarm and stop it sounding.)

Do not attempt to recharge or burn batteries, as they may explode. Wrap in paper and discard normally.

When removing battery, handle carefully to avoid possible eye damage or skin irritation if battery has leaked or corroded.

To maintain sensitivity to smoke, do not paint or cover smoke alarm in any manner; do not permit any accumulation of cobwebs, dust or grease.

The chamber located in the center of the Smoke Alarm contains a small amount of radioactive material. Do not tamper with the chamber. You may safely change the battery and clean the Smoke Alarm following instructions in this leaflet. In the United Kingdom Ionisation Smoke Alarms can be disposed of in normal household refuse, but due to the tiny amount of radioactive material contained in the unit, no more than one alarm per dustbin.

In the Republic of Ireland Ionisation smoke alarms should be returned for disposal to the nearest address at the end of this leaflet.

If unit has been damaged in any way or does not function properly, do not attempt a repair. Return Smoke Alarm (see Getting your Smoke Alarm Serviced page 14.)

This appliance is intended for household use ONLY and not for commercial or industrial use.

This is not a portable product. It must be mounted following the instructions in this Use & Care leaflet.

Smoke Alarms are not a substitute for insurance. The supplier or manufacturer is not your insurer.

(b) Limitations of Smoke Alarms.

Smoke Alarms have significantly helped to reduce the number of fire fatalities in countries where they are widely installed.

However independent authorities have stated that they may be ineffective in up to 35% of all fires. There are a number of reasons for this:

Smoke Alarms will not work if the batteries are depleted or if they are not connected, or if the wrong type of battery is used. Test regularly and replace batteries at least yearly or when depleted.

Smoke Alarms will not detect fire if sufficient smoke does not reach the alarm. Smoke may be prevented from reaching the Alarm if the fire is too far away, for example, if the fire is on another floor, behind a closed door, in a chimney, in a wall cavity, or if the prevailing air drafts carry the smoke away. Installing smoke alarms on both sides of closed doors and installing more than one smoke alarm as recommended in this leaflet very significantly improve the probability of early detection.

The Smoke Alarm may not be heard.

A smoke alarm may not wake a person who has taken drugs or alcohol.

Smoke Alarms may not detect every type of fire to give sufficient early warning. They are particularly ineffective with: fires caused by smoking in bed, escaping gas, violent explosions, poor storage of flammable rags and/or liquids, (for example petrol, paint, spirits etc), overloaded electrical circuits, arson, children playing with matches.

Smoke Alarms don't last indefinitely. The manufacturer recommends replacement after 10 years as a precaution.

Planning your Escape for when the Alarm goes off

Use the Smoke Alarm Test Button to familiarize your family with the Alarm sound and to practice fire drills regularly with all family members. Draw up a floor plan that will show each member at least 2 escape routes from each room in the house. Children tend to hide when they don't know what to do. Teach children how to escape, open windows, and use roll up fire ladders and stools without adult help. Make sure they know what to do if the alarm goes off - see next page.

1. Check room doors for heat or smoke. Do not open a hot door. Use an alternate escape route. Close doors behind you as you leave.



2. If smoke is heavy, crawl out, staying close to floor. Take short breaths, if possible, through a wet cloth or hold your breath. More people die from smoke inhalation than from flames.



3. Get out as fast as you can. Do not stop for packing. Have a prearranged meeting place outside for all family members. Check everybody is there.



4. Call the Fire Brigade from a neighbour's house. Remember to give your name and address.



5. NEVER re-enter a burning house.



(b) FIRE SAFETY HINTS.

Store petrol and other flammable materials in proper containers.

Discard oily or flammable rags.

Always use a metal fireplace screen and have chimneys cleaned regularly.

Replace worn receptacles, switches, home wiring and cracked or frayed electrical cords and plugs.

Do not overload electrical circuits.

Keep matches away from children.

Never smoke in bed. In rooms where you do smoke, always check under cushions for smoldering cigarettes and ashes.

Service furnaces and heating systems regularly.

Be sure all electrical appliances and tools have a recognized approval label.

This device cannot protect all persons at all times. It may not protect against the three most common causes of fatal fires:

1. Smoking in bed.
2. Leaving children at home alone.
3. Cleaning with flammable liquids, such as petrol.

Further information can be obtained from the Home Office Publication entitled "Smoke Detectors in the Home" (FB2) or from your local fire prevention officer.

Getting your Smoke Alarm Serviced

If your Smoke Alarm fails to work after you have read the sections on "Connecting the battery" and "Looking after your Smoke Alarm" contact Customer Assistance at the nearest address given at the end of this leaflet. If it needs to be returned for repair or replacement put it in a padded box (battery disconnected) and send it to "Customer Assistance and Information" at the nearest address given on the Smoke Alarm or in this leaflet. State the nature of the fault, where the Smoke Alarm was purchased and the date of purchase.

Five Year Product Guarantee (excluding battery)

EI Co. Ltd. guarantees this product (excluding battery) against any defects that are due to faulty material or workmanship for a five year period after the original date of consumer purchase or receipt as a gift. This guarantee does not include damage to the product resulting from accident or misuse. It also excludes incidental and consequential damages. If the product should become defective within the warranty period, we will replace it free of charge. (see "Getting Your Smoke Alarm Serviced")

Do not interfere with the product or attempt to tamper with it. This will invalidate the guarantee.

EI Electronics

9 Grundy Street, Liverpool L5-9SG, U.K.
or Shannon, Co. Clare, Ireland.

IMPORTANT NOTICE

WHEN THE BATTERY IS FIRST CONNECTED THE ALARM MAY SOUND FOR 2-3 SECONDS.

THIS IS NORMAL.

IT MEANS THE BATTERY IS CONNECTED CORRECTLY.

© EI Electronics. 2001

P/N B10277-7

9 VOLT IONISATION



INSTRUCTION LEAFLET (for all Models)
Contains vital information on unit operation and installation. Read and retain carefully. If you are just installing this unit this leaflet **MUST** be given to the householder.

MODELS: EI 100B STANDARD
EI 100C INTERCONNECT
EI 100L EMERGENCY LIGHT
EI 100S SILENCER