



Operating instructions

Capriz 2

24c

28c

GB, IE

Contents

Contents	6	Care and maintenance	13
1 Safety	3	6.1 Maintenance	13
1.1 Action-related warnings	3	6.2 Caring for the product	14
1.2 Intended use	3	6.3 Checking the condensate drain pipework and tundish.....	14
1.3 General safety information.....	4	7 Decommissioning.....	14
2 Notes on the documentation	7	7.1 Temporarily decommissioning the product.....	14
2.1 Observing other applicable documents	7	7.2 Permanently decommissioning the product.....	14
2.2 Storing documents.....	7	8 Recycling and disposal.....	14
2.3 Applicability of the instructions.....	7	9 Guarantee and customer service	14
3 Product description.....	7	9.1 Guarantee.....	14
3.1 CE label	7	9.2 Customer service.....	14
3.2 Serial number	7	Appendix	15
3.3 Information on the identification plate	7	A Operator level – overview	15
3.4 Product design.....	8	B Troubleshooting	15
3.5 Overview of the operator control elements	8		
3.6 Description of the display.....	9		
3.7 Description of button functions	9		
3.8 Timer.....	10		
3.9 Operating levels.....	10		
4 Operation.....	10		
4.1 Starting up the product	10		
4.2 Basic display.....	10		
4.3 Checking the heating system pressure.....	10		
4.4 Filling the heating installation.....	11		
4.5 Selecting the operating mode.....	11		
4.6 Setting the hot water temperature	11		
4.7 Setting the heating flow temperature	12		
4.8 Product settings	12		
4.9 Setting the timer.....	12		
4.10 Switching the product to standby mode	12		
4.11 Frost protection.....	13		
5 Troubleshooting	13		
5.1 Detecting and rectifying faults.....	13		
5.2 Fault codes in the display	13		

1 Safety

1.1 Action-related warnings

Classification of action-related warnings

The action-related warnings are classified in accordance with the severity of the possible danger using the following warning signs and signal words:

Warning symbols and signal words



Danger!

Imminent danger to life or risk of severe personal injury



Danger!

Risk of death from electric shock



Warning.

Risk of minor personal injury



Caution.

Risk of material or environmental damage

1.2 Intended use

There is a risk of injury or death to the user or others, or of damage to the product and other property in the event of improper use or use for which it is not intended.

The product is intended as a heat generator for closed cent-

ral heating installations and for hot water generation.

Intended use includes the following:

- observance of the operating instructions included for the product and any other system components
- compliance with all inspection and maintenance conditions listed in the instructions.

This product can be used by children aged from 8 years and above and persons with reduced physical, sensory or mental capabilities or lack of experience and knowledge if they have been given supervision or instruction concerning use of the product in a safe way and understand the hazards involved. Children shall not play with the product. Cleaning and user maintenance shall not be made by children without supervision. Children must not play with the product. Cleaning and user maintenance work must not be carried out by children unless they are supervised.

Any other use that is not specified in these instructions, or use beyond that specified in this document shall be considered improper use. Any direct com-

1 Safety

mercial or industrial use is also deemed to be improper.

Caution.

Improper use of any kind is prohibited.

1.3 General safety information

1.3.1 Installation by skilled tradesmen only

The installation, inspection, maintenance and repair of the product, as well as the gas ratio settings, must only be carried out by a competent person.

1.3.2 Danger caused by improper operation

Improper operation may present a danger to you and others, and cause material damage.

- ▶ Carefully read the enclosed instructions and all other applicable documents, particularly the "Safety" section and the warnings.

1.3.3 Risk of death from escaping gas

What to do if you smell gas in the building:

- ▶ Avoid rooms that smell of gas.
- ▶ If possible, open doors and windows fully and ensure adequate ventilation.

- ▶ Do not use naked flames (e.g. lighters, matches).
- ▶ Do not smoke.
- ▶ Do not use any electrical switches, mains plugs, doorbells, telephones or other communication systems in the building.
- ▶ If it is safe to do so, close the emergency control valve or the main isolator.
- ▶ If possible, close the gas isolator cock on the product.
- ▶ Warn other occupants in the building by yelling or banging on doors or walls.
- ▶ Leave the building immediately and ensure that others do not enter the building.
- ▶ Notify the gas supply company or National Grid Transco +44 (0) 800 111999 by telephone from outside of the building.

1.3.4 Risk of death due to a blocked or leaking flue gas pipe

What to do if you smell flue gas in the property:

- ▶ Open all accessible doors and windows fully to provide ventilation.
- ▶ Switch off the product.
- ▶ Inform a competent person.



1.3.5 Risk of death from escaping flue gas

If you operate the product with an empty condensate siphon, flue gas may escape into the room air.

- ▶ In order to operate the product, ensure that the condensate siphon is always full.

1.3.6 Risk of death due to explosive and flammable materials

- ▶ Do not use or store explosive or flammable materials (e.g. petrol, paper, paint) in the installation room of the product.

1.3.7 Risk of death due to lack of safety devices

A lack of safety devices (e.g. expansion relief valve, expansion vessel) can lead to potentially fatal scalding and other injuries, e.g. due to explosions.

- ▶ Ask a competent person to explain how the safety devices work and where they are located.

1.3.8 Risk of death due to changes to the product or the product environment

- ▶ Never remove, bridge or block the safety devices.

- ▶ Do not alter the safety devices in any way.
- ▶ Do not damage or remove any seals on components.
- ▶ Do not make any changes:
 - The product itself
 - to the gas, air, water and electricity supplies
 - to the entire flue gas installation
 - to the entire condensate drain system
 - to the expansion relief valve
 - to the drain lines
 - to constructional conditions that may affect the operational reliability of the product

1.3.9 Risk of injury and material damage due to maintenance and repairs carried out incorrectly or not carried out at all

- ▶ Never attempt to carry out maintenance work or repairs on your product yourself.
- ▶ Faults and damage should be immediately rectified by a competent person.
- ▶ Adhere to the maintenance intervals specified.



1 Safety

1.3.10 Risk of corrosion damage due to unsuitable combustion and room air

Sprays, solvents, chlorinated cleaning agents, paint, adhesives, ammonia compounds, dust or similar substances may lead to corrosion on the product and in the air/flue pipe.

- ▶ Ensure that the supply of combustion air is always free of fluorine, chlorine, sulphur, dust, etc.
- ▶ Ensure that no chemical substances are stored at the installation site.

1.3.11 Risk of material damage caused by frost

- ▶ Ensure that the heating installation always remains in operation during freezing conditions and that all rooms are sufficiently heated.
- ▶ If you cannot ensure the operation, have a competent person drain the heating installation.



Notes on the documentation 2

2 Notes on the documentation

2.1 Observing other applicable documents

- ▶ You must observe all operating instructions enclosed with the system components.

2.2 Storing documents

- ▶ Keep this manual and all other applicable documents safe for future use.

2.3 Applicability of the instructions

These instructions apply only to:

Product article number

	Article number	Gas Council Number
Capriz 2 24c	0010016127	47-157-27
Capriz 2 28c	0010016129	47-157-28

These products are only designed for natural gas systems.

3 Product description

3.1 CE label



The CE label shows that the products comply with the basic requirements of the applicable directives as stated on the identification plate.

The declaration of conformity can be viewed at the manufacturer's site.

3.2 Serial number

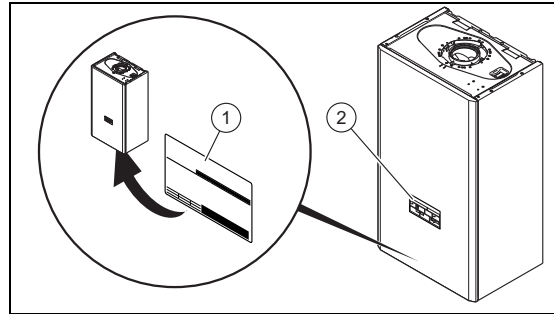

The serial number is located on the identification plate (1) and in the short operating instructions (2) (→ Page 7).





3.3 Information on the identification plate

The identification plate is mounted on the underside of the product in the factory.

The identification plate keeps record of the country in which the product is to be installed.

Information on the identification plate	Meaning
	Barcode with serial number
Serial number	For quality control purposes; 3rd and 4th digits = year of production For quality control purposes; 5th and 6th digits = week of production For identification purposes; 7th to 16th digits = product article number For quality control purposes; 17th to 20th digits = place of manufacture
Capriz 2	Product description
2H, G20 – 20 mbar (2 kPa)	Factory setting for type of gas and gas connection pressure
Cat.	Approved gas category

3 Product description

Information on the identification plate	Meaning
Condensing technology	Efficiency class of the boiler in accordance with EC Directive 92/42/EEC
Type: Xx3(x)	Permissible flue gas connections
PMS	Maximum water pressure in heating mode
PMW	Maximum water pressure in hot water handling mode
V/Hz	Electric connection
W	Max. electrical power consumption
IP	Level of protection
	Heating mode
	Hot water generation
Pn	Nominal heat output range in heating mode
P	Nominal heat output range in hot water handling mode
Qn	Nominal heating load range in heating mode
Qnw	Nominal heating load range in hot water handling mode
T _{max.}	Max. flow temperature
NOx	NOx class for the product
Code (DSN)	Specific product code
	→ "CE label" section
	Read the instructions.
	→ "Recycling and disposal" section
GC no.	Gas council number



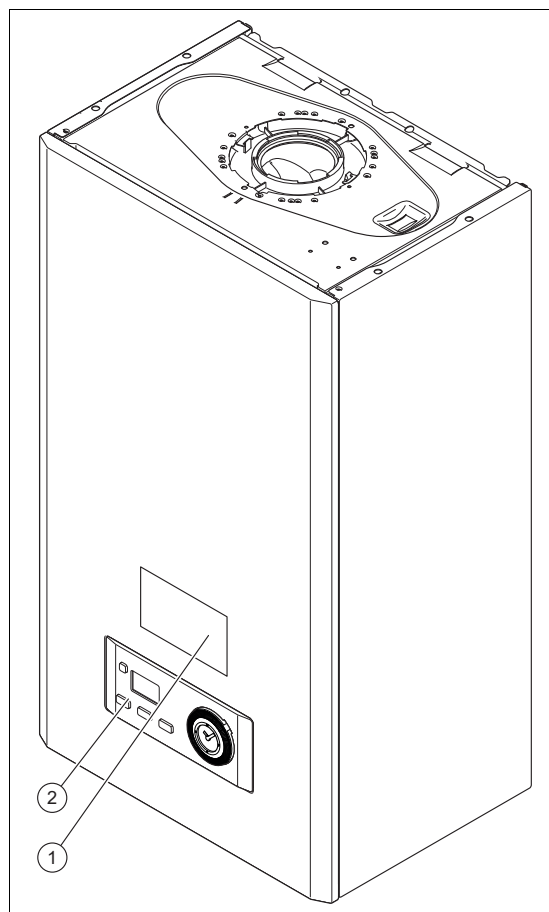

3.4 Product design

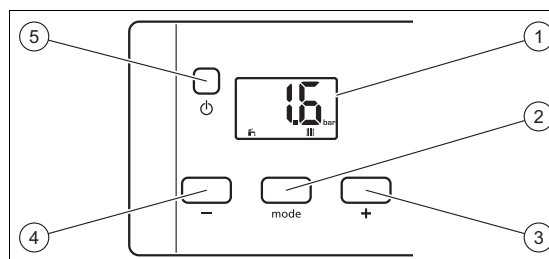

- 1 Magnetic brief operating instructions with type designation and serial number
- 2 Control elements

3.5 Overview of the operator control elements



- 1 Display
- 2  button
- 3  button
- 4  button
- 5  button

Product description 3

3.6 Description of the display

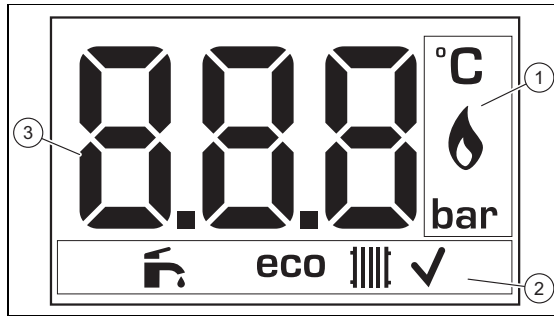

- | | |
|--|---|
| <p>1 Operating information</p> <p>2 Active operating mode, selecting and confirming the operating mode</p> | <p>3 Display showing the current heating flow temperature, the filling pressure in the heating installation, the operating mode or a fault code</p> |
|--|---|

Symbol	Meaning
	Burner operating correctly – Burner on
	Heating installation filling pressure – Permanently on: Filling pressure in the permitted range. – Flashing display: Filling pressure is outside of the permissible range or the purging function has been activated.
	DHW mode – Permanently on: Hot water activated – Flashing: Burner on in draw-off mode
eco	Hot water saving mode – Hot water temperature < 50 °C – Normal operating temperature

Symbol	Meaning
	Heating mode – Permanently on: Heating mode activated – Flashing: Burner on in heating mode
	Display flashing: – Switching on the product – Fault
	Setting confirmed
F.XX / Err	Fault in the product – Appears instead of the basic display.
OFF	– Appears when the product goes into standby mode.

3.7 Description of button functions

Button	Meaning
	– Selecting the operating mode – Confirm the operating mode – Confirm setting – Increase the display contrast
	– Setting the hot water temperature – Setting the heating flow temperature – Increase or decrease the selected setting – Increase the display contrast
	– Activate the product: On/off (standby) – Reset the product

Adjustable values flash on the display. You must confirm any change to a value. Only then is the new setting saved.

If you do not press any buttons for five seconds, the displays switches back to the basic display.

If you do not press any buttons for one minute, the display contrast decreases.

4 Operation

3.8 Timer

You can control the heating mode using the timer.

Position for the selection switch	Functionality
0	Heating mode permanently switched off
⏪	Heating mode intervals in accordance with the timer
I	Heating mode permanently switched on

► Set the timer. (→ Page 12)

3.9 Operating levels

The product has two operating levels:

- The operator level shows the most important information and offers set-up options which do not require any special prior knowledge.
- Specialised knowledge is required in order to use the installer level (access for competent persons). This is therefore protected by an access code.

Operator level – overview (→ Page 15)

4 Operation

4.1 Starting up the product

4.1.1 Opening the isolator devices

Conditions: The competent person who installed the unit will explain where the isolator devices are and how to handle them.

- Ensure that the gas isolator cock is fully open.
- Ensure that the stop cocks in the heating installation's flow and return are open.
- Ensure that the cold water stop cock is open.

4.1.2 Starting up the product

Applicability: Heatline

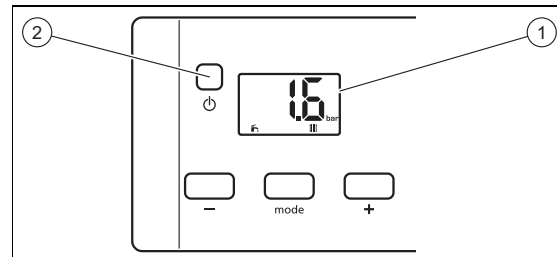

► Press the (2) button.

- ◁ When the unit is switched on, the "Basic display" is shown in the display (1).

4.2 Basic display

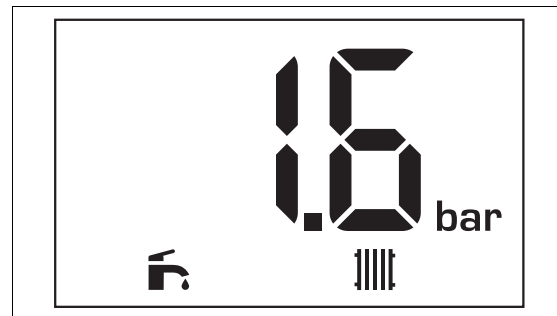

The filling pressure in the heating installation and the operating mode are shown in the display's basic display.

To return to the basic display:

- Wait more than five seconds without pressing any buttons.

If a fault message is present, the basic display switches to the fault code.

4.3 Checking the heating system pressure

1. Once a month, check that the pressure in the central heating system, which is displayed on the user interface, is between 0.1 MPa and 0.15 MPa (1.0 bar and 1.5 bar).
 - ◁ If the filling pressure is correct, no action needs to be taken.

- ▽ If the filling pressure is too low, add more water to the heating installation.



Note

If the heating flow temperature is shown in the display, press and hold the and buttons at the same time for longer than five seconds, or temporarily deactivate heating mode in order to display the pressure.

2. Fill the heating installation. (→ Page 11)

4.4 Filling the heating installation



Caution.

Risk of material damage due to heating water that is extremely calciferous or corrosive or contaminated by chemicals.

Unsuitable tap water damages the seals and diaphragms, blocks components in the product and heating installation through which the water flows and causes noise.

- ▶ Only fill the heating installation with suitable heating water.
- ▶ In case of doubt, ask a competent person for details.



Note

The competent person is responsible for filling the heating installation the first time, any subsequent top-ups and the water quality.

The operator alone is responsible for topping up the water in the heating installation.

1. Open all radiator valves (thermostatic radiator valves) of the heating installation.
2. Slowly open the filling cock, as shown to you by the competent person.
3. Fill with water until the required filling pressure is reached.
4. Check the filling pressure in the display.
5. Close the filling cock after filling.

4.5 Selecting the operating mode



Note

The unit is always activated with the preselected operating mode.

- ▶ Press repeatedly until the display shows the required operating mode.

Symbol	Operating mode
	Heating + hot water
	Heating only
	Hot water only
–	No requirement

4.6 Setting the hot water temperature

Conditions: The temperature is controlled by the boiler

- ▶ Set the hot water temperature on the boiler (→ Page 12).

Conditions: The temperature is controlled by the controller

- ▶ Set the hot water temperature on the controller.



Note

If you press the or button, the display shows the symbol.

4 Operation

4.7 Setting the heating flow temperature

Conditions: Temperature controlled by the boiler, with heating mode activated

- ▶ Set the heating flow temperature on the boiler (→ Page 12).



Note

The competent person may have adjusted the maximum possible temperature.

Conditions: Temperature controlled by the controller, with heating mode activated

- ▶ Set the maximum heating flow temperature on the boiler (→ Page 12).
- ▶ Set the room temperature on the controller.
 - ◁ The actual heating flow temperature is set automatically by the controller.

Conditions: Outside temperature sensor connected to the boiler, with heating mode activated

- ▶ When you press the **mode**, **-** or **+** button.
 - ◁ The display shows the heating flow temperature calculated by the boiler.
 - ◁ The actual heating flow temperature is set automatically by the boiler.

4.8 Product settings



Note

The sequence in which the available settings are shown depends on the operating mode selected. If the **Domestic hot water + Heating** operating mode is selected, the hot water temperature must be confirmed in order to set the flow temperature of the heating.

1. Press the **-** or **+** button to set the temperature.
2. Press the **mode** button to confirm.

4.9 Setting the timer

Applicability: Timer, Great Britain

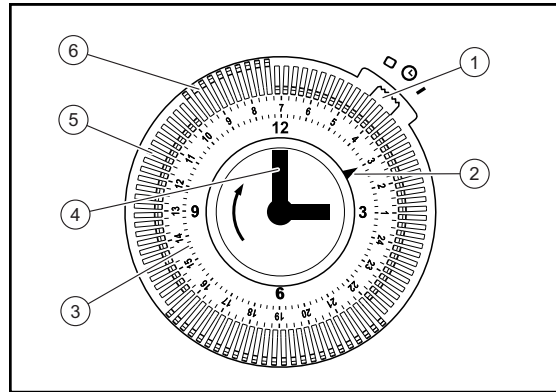

1. Turn the minute hand **(4)** clockwise until the arrow **(2)** points to the current time on the 24-hour dial **(3)**.
2. Slide the pin for the time interval, in which the heating mode should be switched on, outwards **(6)**.
3. Slide the pin for the time interval, in which the heating mode should be switched off, inwards **(5)**.
4. Set the selection switch **(1)** to the mid-position **(⊙)**.

4.10 Switching the product to standby mode

- ▶ Press the **⏻** button for less than three seconds.
 - ◁ Once the requirement currently in use has finished, the display will show **OFF** and go out.
 - ◁ The product is now in standby mode.
 - ◁ The product's frost protection function is activated.
 - ◁ The main power supply is not interrupted. The product continues to be supplied with power.

4.11 Frost protection

4.11.1 The product's frost protection function

The frost protection function switches on the boiler and the pump as soon as the protection temperature in the heating circuit is reached.

- Protection temperature: 12 °C

The pump stops once the minimum water temperature in the heating circuit is reached.

- Minimum water temperature: 15 °C

If the burner ignition temperature in the heating circuit is reached, the burner switch is switched on and continues to operate until the burner anti-cycling temperature is reached.

- Burner ignition temperature: 7 °C
- Burner anti-cycling temperature: 35 °C

The hot water circuit (cold and hot water) is not protected by the boiler.

Frost protection for the system can only be guaranteed by the boiler.

A controller is required to control the temperature of the system.

4.11.2 Frost protection for the system



Note

Ensure that the product's power and gas supply are working correctly.

Conditions: If you are away from home for several days, Without controller

- ▶ Switch the product to standby mode. (→ Page 12)

Conditions: If you are away from home for several days, With controller

- ▶ Program the number of days you will be away in the controller to activate the frost protection devices.

Conditions: If you are away from home for a prolonged period

- ▶ Contact a qualified competent person, who can completely drain the system or protect the heating circuit by adding a special frost protection agent for heating installations.

5 Troubleshooting

5.1 Detecting and rectifying faults

- ▶ If problems occur whilst operating the product, you can carry out certain self-checks with the aid of the table in the appendix.
Troubleshooting (→ Page 15)
- ▶ If the product still does not function without problems after the checks have been carried out using the table, contact your competent person to rectify the problem.

5.2 Fault codes in the display

Fault codes have priority over all other displays. If several faults occur at the same time, the corresponding codes are displayed alternately for two seconds each.

- ▶ If your product displays a fault code (F.xx), contact a competent person.

6 Care and maintenance

6.1 Maintenance

An annual inspection and biennial maintenance of the product carried out by a competent person is a prerequisite for ensuring that the product is permanently ready and safe for operation, reliable, and has a long working life.

7 Decommissioning

6.2 Caring for the product



Caution.

Risk of material damage caused by unsuitable cleaning agents.

- ▶ Do not use sprays, scouring agents, detergents, solvents or cleaning agents that contain chlorine.

- ▶ Clean the casing with a damp cloth and a little solvent-free soap.

6.3 Checking the condensate drain pipework and tundish

The condensate drain pipework and tundish must always be penetrable.

- ▶ Regularly check the condensate drain pipework and tundish for faults and, particularly, for blockages.

You must not be able to see or feel any obstructions in the condensate drain pipework and tundish.

- ▶ If you notice a fault, have it rectified by a competent person.

7 Decommissioning

7.1 Temporarily decommissioning the product

- ▶ Temporarily decommission the product only if there is no risk of frost.
- ▶ Switch off the product via the main switch provided on-site.
 - ◁ The display goes out.
- ▶ When decommissioning for an extended period (e.g. holiday), you should also close the gas isolator cock and the cold water stop cock.

7.2 Permanently decommissioning the product

- ▶ Have a competent person permanently decommission the product.

8 Recycling and disposal

- ▶ The competent person who installed your product is responsible for the disposal of the packaging.



If the product is identified with this symbol:

- ▶ In this case, do not dispose of the product with the household waste.
- ▶ Instead, hand in the product to a collection centre for old electrical or electronic appliances.



If the product contains batteries that are marked with this symbol, these batteries may contain substances that are hazardous to human health and the environment.

- ▶ In this case, dispose of the batteries at a collection point for batteries.

9 Guarantee and customer service

9.1 Guarantee

For information on the manufacturer's guarantee, you can write to the contact address that is provided on the back page.

9.2 Customer service

For contact details for our customer service department, you can write to the address that is provided on the back page, or you can visit www.heatline.co.uk.

Appendix

A Operator level – overview

Setting level	Values		Unit	Increment, select	Default setting
	Min.	Max.			
Heating installation					
Pressure in the heating installation	Current value		bar	0.1	
	1	1.5			
Heating flow temperature	Current value		°C	1	60
	10	Preset in the system			
Hot water generation					
Hot water temperature	Current value		°C	1	55
	35	60			
Eco hot water temperature	Current value		°C	1	
	35	50			

B Troubleshooting

Fault	Cause	Measure
Product does not start up: – No hot water – Heating does not heat up	The gas isolator cock installed on-site and/or the gas isolator cock on the product is closed.	Open both gas isolator cocks.
	The cold water stop cock is closed.	Open the cold water stop cock.
	The power supply in the building is disconnected.	Check the fuse in the building. The product automatically switches on after the power supply is restored.
	The product is switched off.	Switch on the product (→ "Switching on the product" section).
	The heating flow temperature or hot water temperature has been set too low.	Set the heating flow temperature and hot water temperature (→ "Setting the heating flow temperature" section/→ "Setting the hot water temperature" section).
	The system pressure is insufficient. Low water pressure in the heating installation (fault code: F.22).	Fill the heating installation (→ "Filling the heating installation" section). If the pressure drops frequently, contact your competent person about this.

Appendix

Fault	Cause	Measure
Product does not start up: – No hot water – Heating does not heat up	The system pressure is too high.	Purge a radiator in order to reduce the pressure in the heating installation, or contact your competent person about this.
	There is air in the heating installation.	Purging the radiators If the problem occurs again: Inform the competent person
	After three successive failed ignition attempts, the system switches to fault mode (fault code: F.28).	Press the  button. The product carries out a new ignition attempt. If the ignition problem is not rectified after three fault clearance attempts, contact a competent person.
Hot water generation functioning correctly; heating does not start up.	The external controller is not set correctly.	Set the external controller correctly (→ Controller operating instructions).

Publisher/manufacturer

Heatline

Nottingham Road – Belper – DE56 1JT
Sales 01773 596611 – Fax 01773 828123
info@heatline.co.uk



{}0020206382_02 - 27.08.2015 11:31:14

© These instructions, or parts thereof, are protected by copyright and may be reproduced or distributed only with the manufacturer's written consent.

