



**MAINS POWERED  
CARBON MONOXIDE ALARMS  
WITH RECHARGEABLE LITHIUM CELL BACK-UP**



**Model Ei261ENRC**

**Model Ei261DENRC  
WITH DIGITAL DISPLAY**

Read and retain carefully for as long as the product is being used. Contains vital information on the operation and installation. This leaflet should be regarded as part of the product.

If you are just installing the unit, **this leaflet must be given to the householder**. This leaflet is to be given to any subsequent user.

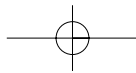
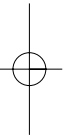
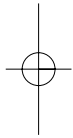
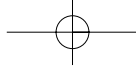

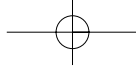

# CONTENTS

	Page
<b>1 IMPORTANT INFORMATION</b>	<b>4</b>
<b>2 CARBON MONOXIDE - THE SILENT KILLER</b>	<b>6</b>
<b>3 ALARM POSITIONING</b>	<b>10</b>
<b>4 INSTALLATION</b>	<b>15</b>
<b>5 TESTING</b>	<b>20</b>
<b>6 HOW TO DISTINGUISH BETWEEN CO ALARM &amp; SMOKE ALARM WARNINGS</b>	<b>22</b>
<b>7 MAINTENANCE</b>	<b>22</b>
<b>8 LIMITATIONS OF CO ALARMS</b>	<b>24</b>
<b>9 HOW TO PROTECT YOUR FAMILY</b>	<b>25</b>
<b>10 GETTING YOUR CO ALARM SERVICED</b>	<b>27</b>
<b>11 FIVE YEAR GUARANTEE</b>	<b>27</b>
<b>12 TECHNICAL SPECIFICATIONS</b>	<b>28</b>
<b>13 TROUBLESHOOTING</b>	<b>30</b>
<b>14 ACCESSORIES</b>	<b>32</b>

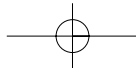

## 1. IMPORTANT INFORMATION

**WARNING:** The Alarm should be permanently wired to the mains by a qualified electrician in accordance with IEE wiring regulations (BS7671).

- Install a Carbon Monoxide (CO) Alarm in every room that contains a fuel burning appliance, particularly rooms where people spend a lot of time e.g. bedrooms, kitchens and sitting rooms.
- In rooms with an appliance, install (preferably) on the ceiling (300mm from walls and between 1m to 3m horizontally from appliance). In rooms remote from the appliance install at breathing level, where the light indicators can be seen.
- Regularly check that the green power light is on, so that rechargeable back-up cells will remain fully charged. **Important:** The CO Alarm will not work if the mains supply is off and the rechargeable cells are depleted.
- Test the unit weekly by pressing and holding the Test/Hush button. The horn will sound.
- Replace sensor module after 5 years operation (see page 23).

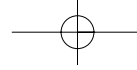



**?** **WHAT TO DO WHEN THE ALARM SOUNDS:**

- (1) Open the doors and windows to ventilate the area.
- (2) Turn off all fuel appliances where possible. (The alarm can be silenced immediately by pushing the Test/Hush button).
- (3) Evacuate the property leaving the doors and windows open.
- (4) Get medical help immediately for anyone suffering the effects of Carbon Monoxide poisoning (headache, nausea), and advise that Carbon Monoxide poisoning is suspected.
- (5) Ring your gas or other fuel supplier on their emergency number. Keep the number in a prominent place.
- (6) Do not re-enter the property until the alarm has stopped. (If the alarm has been silenced by pressing the Test/Hush button, wait at least 5 minutes. The alarm will then check that the CO has cleared).
- (7) Do not use the fuel appliances again until they have been checked by an expert. In the case of gas appliances this must be a Registered Gas Installer.

**?** When the CO Alarm detects abnormal levels of CO (above 50ppm CO) the **red light** starts to flash and the horn will sound within 90 minutes. At higher levels of CO the alarm will turn on sooner (see Table B - page 8).

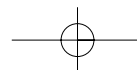
**?** The CO Alarm will automatically reset once the CO has cleared. Pressing the Test/Hush button will silence the CO Alarm immediately (below 300ppm CO). If CO is still present the red light and horn will turn on again after about 4 minutes.



 The CO Alarm is no substitute for keeping chimneys and flues clear and in good condition, and all of your appliances serviced regularly according to the manufacturer's instructions.

 Do not fit alarm until all building work is completed to avoid contamination.

## 2. CARBON MONOXIDE - THE SILENT KILLER

### 2.1 WHAT IS CARBON MONOXIDE ?

Congratulations on becoming the owner of an Ei Carbon Monoxide Alarm. This will help protect you and your household from the dangerous effects of Carbon Monoxide - The Silent Killer. Many are killed each year, and many more suffer ill health from Carbon Monoxide (CO) poisoning (CO is the chemical symbol, indicating the molecule has one carbon atom and one oxygen atom). CO is an invisible, odourless, tasteless and extremely toxic gas. It is produced by appliances and vehicles burning fuels, such as coal, oil, natural/bottled gas, paraffin, wood, petrol, diesel, charcoal etc. CO is absorbed by red blood cells in the lungs in preference to oxygen - this results in rapid damage to the heart and brain from oxygen starvation.

#### **High levels of CO in a house can be caused by:**

- Incorrectly or poorly installed fuel-burning appliances.
- Blocked or cracked chimneys/flues.
- Blocked vents or draught-proofing which makes areas with fuel burning appliances or fireplaces airtight.
- Engines of cars, lawnmowers etc. left running in confined spaces.
- Portable paraffin or gas heaters in badly ventilated rooms.

### 2.2 SYMPTOMS OF CARBON MONOXIDE POISONING

Most people know that high levels of CO are harmful, however the period of exposure is also important.

A low level for a long period (e.g. 150 ppm for 90 minutes) can cause the same symptoms (a slight headache) as a high level of CO for a short period (e.g. 350 ppm CO for 30 minutes). Table A shows how exposure to different concentrations of CO generally affects people.

Many cases of reported Carbon Monoxide poisoning indicate that while victims are aware they are not well, they become so disorientated they are unable to save themselves by either leaving the building or calling for assistance. Young children and household pets may be the first affected.

**Table A: Effects of Carbon Monoxide Poisoning**

Concentration of CO in Air ppm <sup>▲</sup>	Inhalation Time (approx) and Symptoms Developed
<b>35</b>	The maximum allowable concentration for continuous exposure in any 8 hour period according to OSHA *.
<b>150</b>	Slight headache after 1.5 hours.
<b>200</b>	Slight headache, fatigue, dizziness, nausea after 2-3 hours.
<b>400</b>	Frontal headaches within 1-2 hours, life threatening after 3 hours, also maximum parts per million in flue gas (on an air free basis) according to US Environmental Protection Agency.
<b>800</b>	Dizziness, nausea and convulsions within 45 minutes. Unconsciousness within 2 hours. Death within 2-3 hours.
<b>1,600</b>	Headache, dizziness and nausea within 20 minutes. Death within 1 hour.
<b>3,200</b>	Headache, dizziness and nausea within 5-10 minutes. Death within 25-30 minutes.
<b>6,400</b>	Headache, dizziness and nausea within 1-2 minutes. Death within 10-15 minutes.
<b>12,800</b>	Death within 1-3 minutes.

▲ ppm = parts per million

\*OSHA = Occupational Safety & Health Association

### 2.3 WHAT HAPPENS WHEN YOUR CO ALARM DETECTS CARBON MONOXIDE ?

When the Alarm detects potentially dangerous levels of CO, it flashes the red alarm light and then sounds a loud alarm if the CO persists. The digital display (Model Ei261DENRC only) indicates the CO level in parts per million (ppm) CO.

Table B below shows how the CO Alarm reacts to different levels of CO gas and exposure time. At higher levels of CO the alarm turns on sooner. The rate of flashing of the red light indicates the level of CO.

**Table B: CO Alarm Response**

CO Level (ppm)	Red Alarm Light	Horn sounds within
0	Off *	Off
50	1 Flash / 2 Seconds	60 to 90 minutes
100	2 Flashes / Second	10 to 40 minutes
300	4 Flashes / Second	3 minutes

\* unless it has been in alarm (see 2.4 CO Alarm Memory overleaf)

**If your CO Alarm sounds follow the instructions on page 5.**

When ventilation is provided by leaving windows and doors open, the CO build up may have dissipated by the time help arrives and the alarm may have stopped sounding. Although your problem may appear temporarily solved, it is crucial that the source of the CO is determined and appropriate repairs made.



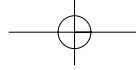

## NEVER IGNORE THE ALARM

**Pre-Alarm:** When the alarm detects over 50ppm CO the red light flashes every 2 seconds. This helps locate CO leaks as the unit gives an indication straight away (without this feature the CO level would need to be at 50ppm CO for 90 minutes for the horn to sound). Note the Pre-Alarm signal may be triggered by CO coming for example, from cooking with gas, from car engines or from nearby barbecues. This is usually not a concern unless the Pre-Alarm signal persists until the alarm sounds and the CO source is unknown.

**Note:** The CO Alarm may sound if cigarette smoke is blown into it, or aerosols are released nearby.

### 2.4 CO ALARM MEMORY

When the Test button is pressed the horn will sound, and the red light will only flash if the unit has previously detected CO and been in alarm. The flash rate indicates the level of CO detected as below:-

- **Red light is Off** – No CO detected since reset or power up.
- **Red light flashes 2 times** (in 2 seconds) every 40 seconds - 50 ppm CO detected for approximately 90 minutes since reset or power-up.
- **Red light flashes 4 times** (in 2 seconds) every 40 seconds - 100 ppm CO detected for approximately 40 minutes since reset or power-up.
- **Red light flashes 8 times** (in 2 seconds) every 40 seconds - 300 ppm CO detected for approximately 3 minutes.

When the Test button is held, the digital display on the Ei261DENRC model shows the previous peak reading. This tells you if the unit has detected CO in your absence and helps to detect and locate leaks, monitor premises etc.

**Reset Memory** by holding down the Test button for over 20 seconds until the red light stops flashing. Cover the horn with a cloth to muffle the alarm during this time.

Please note that the memory will also be reset when the unit is removed from the mounting plate.

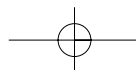

### 3. ALARM POSITIONING

#### 3.1 IDEALLY A CARBON MONOXIDE (CO) ALARM SHOULD BE INSTALLED IN:

- Every room containing a fuel burning appliance
- Remote rooms where occupants spend a considerable amount of time
- Every bedroom

However if the number of CO Alarms is limited, the following points should be considered when deciding where best to fit the alarm(s)

- If there is an appliance in a room where people sleep, place a CO Alarm in this room
- Locate a CO Alarm in a room containing a flueless or open-flued appliance
- Locate a CO Alarm in a room where the occupant(s) spend most of their time (e.g. living room)
- In a bedsit, the CO Alarm should be placed as far away from the cooking appliance as possible, but near to where the occupant sleeps
- If the appliance is in a room not normally used (such as a boiler room) the CO Alarm should be placed just outside the room so that the alarm will be heard more easily

#### 3.2 UNSUITABLE LOCATIONS

**Do not** place the CO Alarm in any of the following areas

- In the immediate vicinity of a cooking appliance
- Outside the building

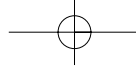

- In an enclosed space (e.g. in or below a cupboard)
- In a damp or humid area
- Directly above a sink or cooker
- Next to a door, window, air vent or anywhere that it would be affected by draughts
- Next to an extractor fan
- Where it would be obstructed, e.g. by curtains or furniture
- In an area where the temperature could drop below  $-10^{\circ}\text{C}$  or rise above  $40^{\circ}\text{C}$
- Where dirt or dust could block the sensor
- Where it could be easily knocked or damaged, or where it could be accidentally turned off or removed
- In a bathroom or other areas where the CO Alarm may be exposed to water splashes, dripping or condensation (e.g. above an electric kettle)
- Near paint, thinners, solvent fumes or air fresheners

### **3.3 IF LOCATING THE CO ALARM IN A ROOM WITH A FUEL BURNING APPLIANCE** (see *Figure 1*)

- If it is mounted on a wall, it should be located at a height greater than the height of any door or window but still be at least 150mm from the ceiling
- If it is mounted on the ceiling it should be at least 300mm from any wall or light fitting
- The CO alarm should be a horizontal distance of between 1m and 3m from the potential CO source

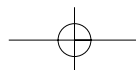

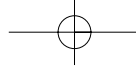

- If there is a partition in the room, the CO Alarm should be located on the same side of the partition as the potential source
- In rooms with sloped ceilings, the CO Alarm should be located at the high side of the room (see *Figure 3*)

### **3.4 IF LOCATING THE CO ALARM IN A BEDROOM OR IN ROOMS REMOTE FROM A FUEL BURNING APPLIANCE (see *Figure 3*)**

- Mount the CO alarm relatively close to the breathing zone of the occupants

Whatever position is chosen make sure it is possible to view the three light indicators, when in the vicinity of the alarm.

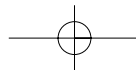
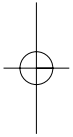
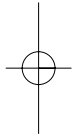

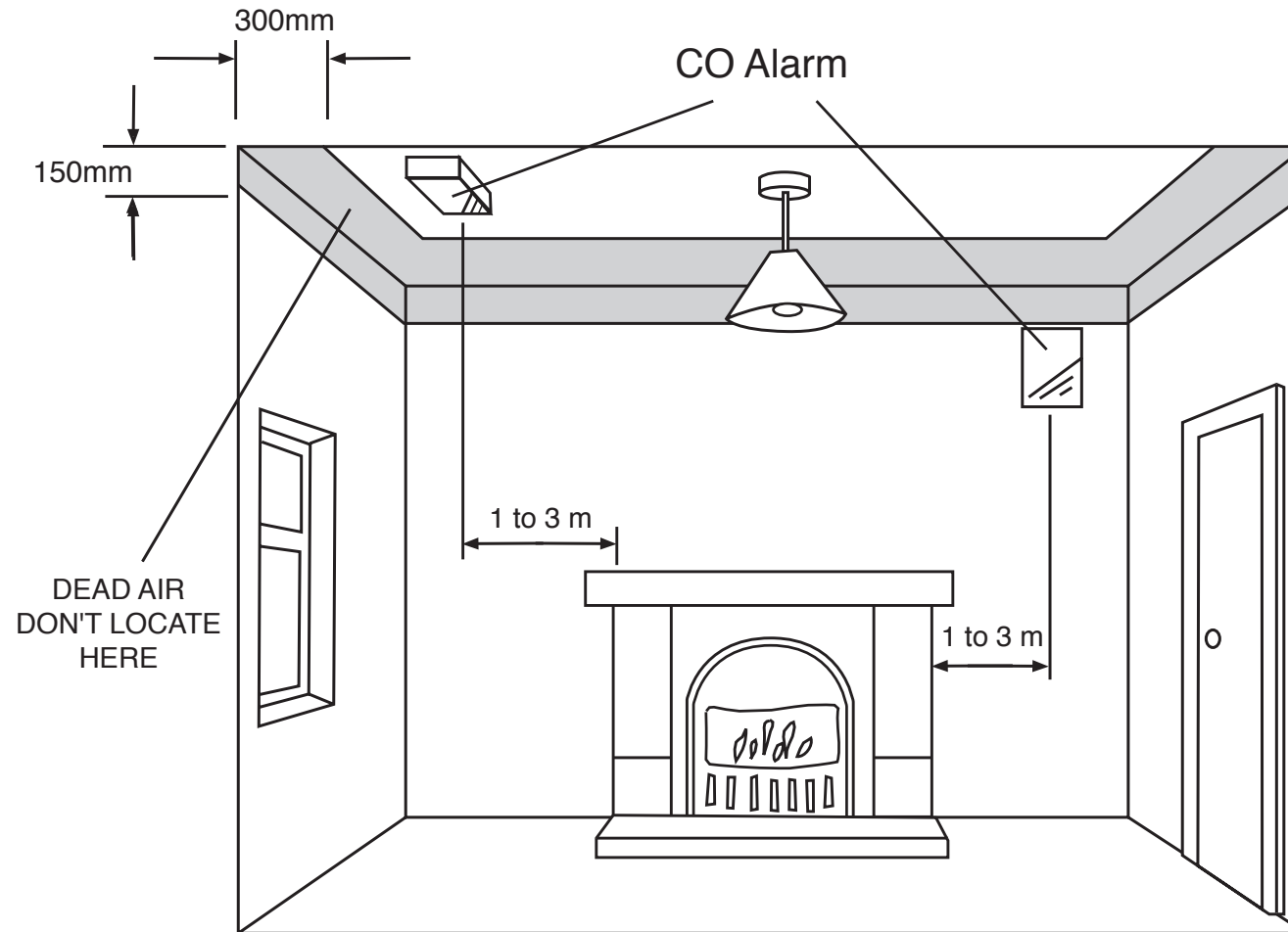

**Figure 1.** Location in room with a fuel burning appliance

- 1 to 3m from appliance
- Ceiling 300mm (min) from walls
- Wall 150mm vertically down from ceiling

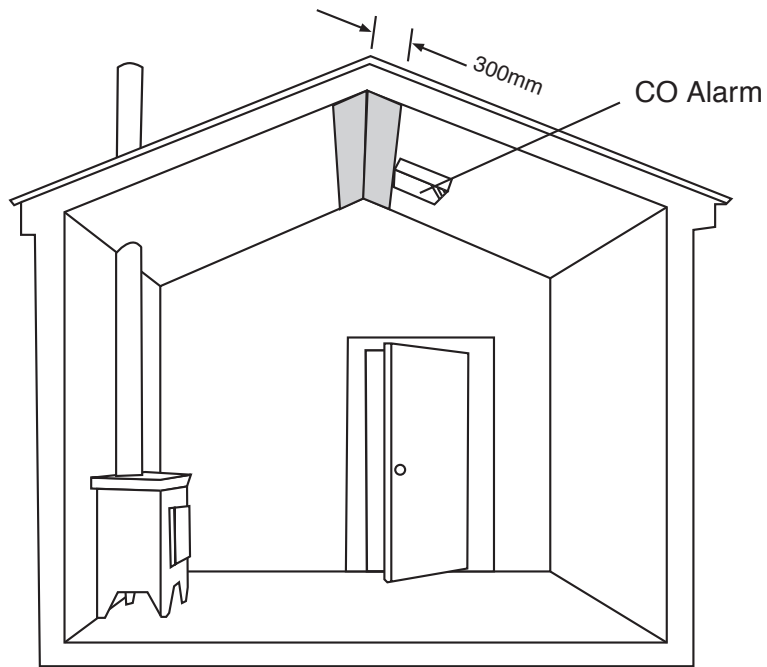

**Figure 2.** Location in rooms with sloped ceilings

- 300mm from apex of ceiling
- High side of the room

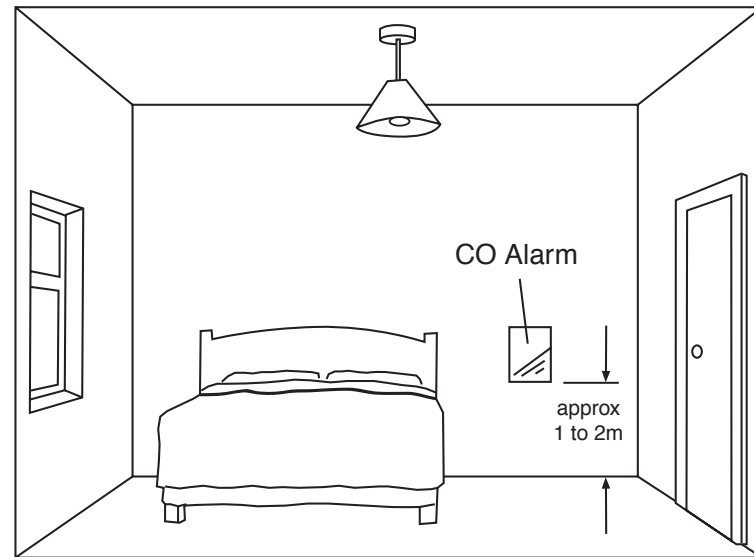

**Figure 3.** Location in bedroom & rooms remote from the appliance

- Wall mounted
- Breathing level (approx. 1 to 2m above floor)

## 4. INSTALLATION

The Alarm is designed to be permanently mounted, using its own built-in terminal block to connect it to the mains wiring. The mounting plate can be screwed directly to the ceiling/wall. Alternatively it can be screwed to a standard junction box (BS 4662 single gang accessory box). The alarm requires a current of 60mA. The Alarm must not be exposed to dripping or splashing. There are important markings on the underside of the alarm.

**IMPORTANT PRECAUTION:** Do not install the actual alarm itself in new or renovated buildings until all work is completed (including floor coverings) and the building has been fully cleaned. The wiring can be installed when appropriate. (Excessive dust and debris from building work can contaminate the sensor and cause problems, it will also invalidate the guarantee). If it must be installed, cover it completely, particularly around the edges, with a suitable covering, until all cleaning is finished.

**Figure 4 - Alarm Installation**

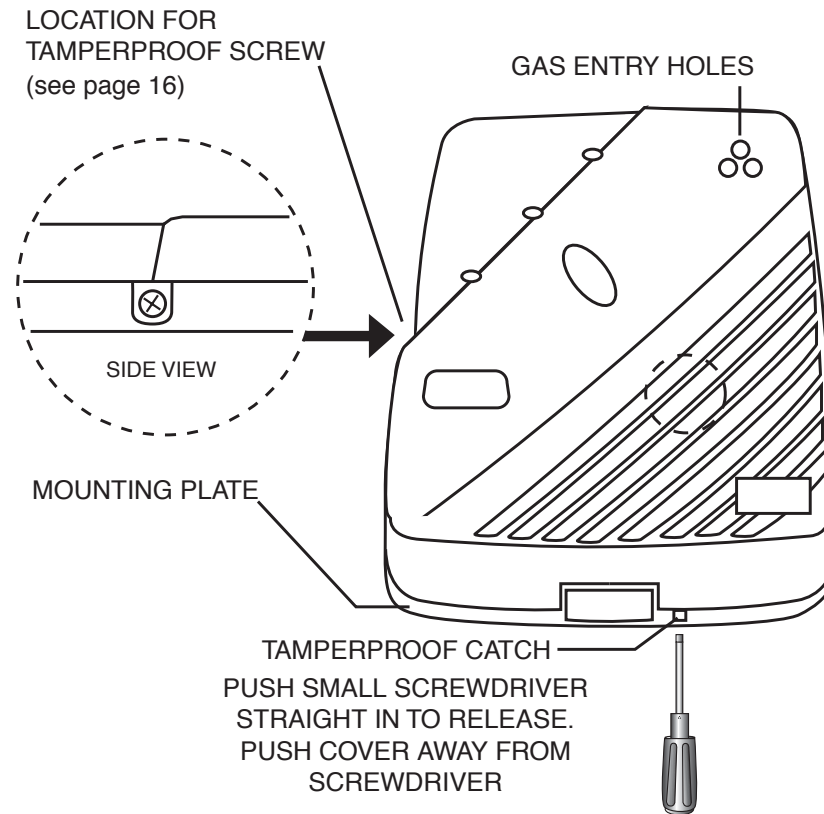

**WARNING:** DISCONNECT MAINS BEFORE REMOVING ALARM FROM CEILING OR WALL

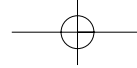

The Alarm must **not** be connected when the house wiring insulation is being checked with high Voltages i.e. do not use an insulation tester on the alarm.

- Do not use the CO Alarm on an intermittent basis, or as a portable detector for the spillage of combustion products from fuel burning appliances or chimneys.
- Mains operated Alarms should be installed and interconnected by a qualified electrician in accordance with the Requirements for Electrical Installations published by the Institution of Electrical Engineers (as BS7671). Failure to install this Alarm correctly may expose the user to shock or fire hazards.
- The Alarm must be continuously powered 24 hours a day so it is important that it is not on a circuit that can be turned off by a switch.

## INSTALLATION PROCEDURE

1. Select a location complying with the advice in the previous section (see pages 8-12).
2. Disconnect the AC mains supply from the circuit that is going to be used to power the Alarm.
3. The house wiring must be connected to the terminal block on the mounting plate as follows:

**L: Live** - connect to the house wires coloured brown or marked L.

**N: Neutral** - connect to the house wires coloured blue or marked N.

**IC: Interconnect** - If you are only installing one alarm do not connect any cable to the IC terminal.

See page 19 for information on interconnecting.

**Warning:** Mixing the Live and Neutral connections when interconnecting alarms will damage all the alarms - ensure that the same colours are used throughout the premises for Live, Neutral and Interconnect wires.

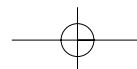



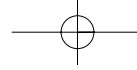

We strongly recommend that you check for the following **before connecting the alarm**:

- check for Live and Neutral using a two probe tester.
- check for Live using a neon tester.
- check that the Interconnect wire is NOT connected to Live, Neutral or Earth. **Do not use an Earth wire for the Interconnect line.**

**Note:** The Alarm does not need to be earthed. However the terminal marked  is provided for the convenience of the installer so that any copper Earth wire or cable coloured green & yellow, can be safely terminated.

4. Lift off the wiring cover as shown in *Figure 5* overleaf.

5. If the mains wires are being brought along the surface, conduit can be inserted into the top and/or bottom of the mounting plate.

(a) position the mounting plate, so that the cable conduit is as shown in *Figure 5* overleaf.

(b) Carefully cut around the knockout on the outside wall so the conduit fits. (**Note:** to comply with the BS EN 60529, IPX2D protection rating, seal around conduit with silicone rubber or similar to prevent water entering).

6. If the mains wiring is recessed, bring the wiring through the rear hole in the mounting plate as shown in *Figure 6*.

7. Carefully align the mounting plate and screw into place. Connect the wires to the terminal block. With recessed wiring, ensure the rear gasket seals around the edge of the hole in the ceiling or wall. This is to prevent air draughts affecting the CO gas entering the alarm. If the hole is not closed off by the gasket it should be sealed with silicone rubber or equivalent.

8. Replace the wiring cover.

9. Carefully line up the unit on the base and slide on.

10. Press the Test/Hush button for 10 seconds. The horn will sound. Check that any interconnected alarms also sound within this period.

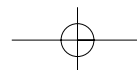

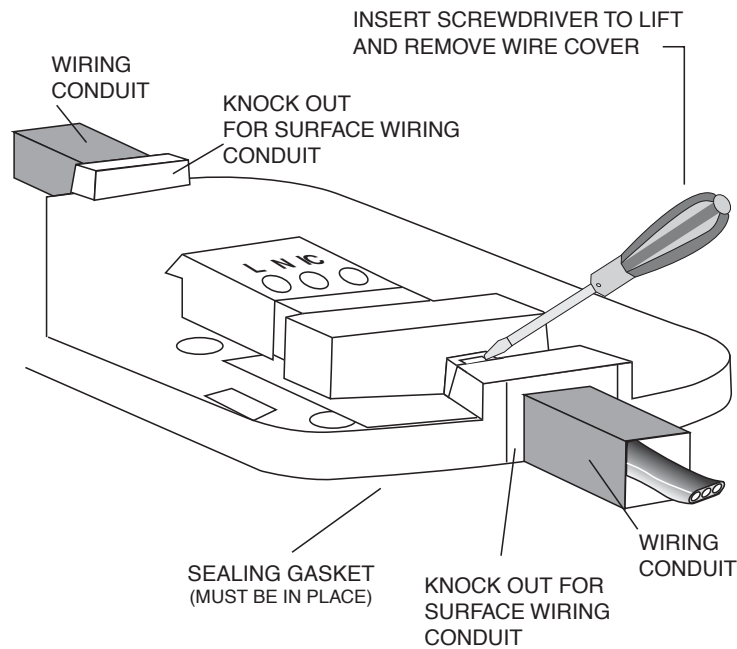

**Figure 5 - Surface Wiring**

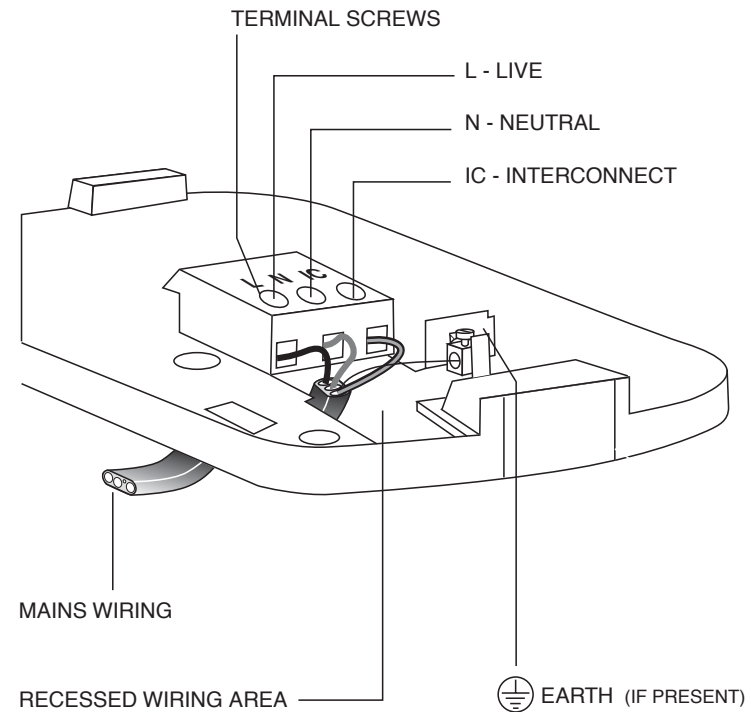
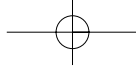

**Figure 6 - Recessed Wiring**

11. Connect the mains power to the alarm circuit. Check the green light is on.

The CO Alarm is now fully operational and will provide protection against a build up of Carbon Monoxide gas 70 seconds after it is connected to the mains supply.

12. The unit may be tamperproofed further by removing the knockout in the sidewall of the mounting plate (as shown in *Figure 4*) and inserting the self tapping screw (3mm diameter, 12mm long) after the unit is on the mounting plate.



### 4.1 INTERCONNECTING

With interconnected alarms, when one unit detects CO all units alarm. All horns will sound but only units detecting CO will flash their red lights.

A maximum of twelve Ei261ENRC/261DENRC CO Alarms may be interconnected along with an Ei128RBU & Ei128COV relay module (see “ACCESSORIES” on page 32).

Alternatively, up to twelve Ei261ENRC /Ei261DENRC CO Alarms and Ei161RC/Ei164RC/Ei166RC Smoke/Heat Alarms may be interconnected **provided an Ei1529RC Remote Control is used** in the system (see “ACCESSORIES” on page 32).

**Do not connect these Alarms to any other model produced by another manufacturer, or to any other model of Ei Alarm, apart from those listed above.** Doing this may damage the Alarms and could result in a shock or fire hazard.

The interconnect wire (minimum 0.75mm<sup>2</sup> cable) must be treated as if it was Live. It should be insulated and sheathed.

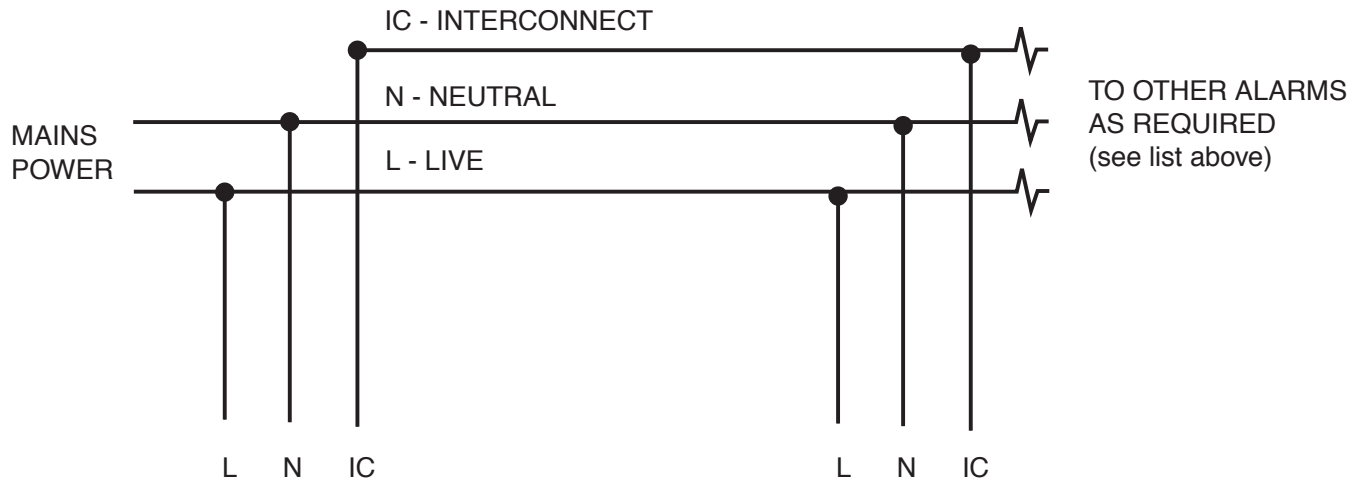

**Figure 7 - Interconnect Wiring Diagram**

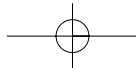

A maximum of 250 metres (820 ft) of wire can be used (maximum resistance between detectors 50 Ohms). Connect as shown in *Figure 7*.

Alarms should be interconnected only within the confines of a single family living unit. If they are connected between different units there may be excessive nuisance alarms. Everybody may not be aware that they are being tested etc.

If interconnected CO and Smoke/Heat Alarms are all sounding, the LOCATE switch on the Ei1529RC Remote Control should be pressed. This will just leave the alarm that triggered the system sounding.

This is very important to determine because the actions to take in each situation are very different.

In the case of CO the premises should be fully ventilated by opening doors and windows. The user should call the gas supplier etc.

In the case of fire, doors and windows should be closed to slow the spread of fire. The user should call the fire brigade etc.

## 5. TESTING

1. Regularly check that the green mains power light is on. The unit cannot detect CO if the mains power is off and the rechargeable battery back-up is depleted. (If it is off check circuit breakers, fuses, wiring etc).
2. Test the unit weekly by pressing the Test/Hush button. Hold the Test button (for up to 10 seconds) until the horn sounds for over 5 seconds. This will help to familiarise you and your family with the distinctive on-off sound of the CO Alarm. This test checks that the electronics and horn are working correctly. If units are interconnected, button test each unit in turn and check all interconnected units alarm. (If the red alarm light flashes when the button is pressed, see 2.4 "CO ALARM MEMORY" on page 9). Alternatively, if an Ei1529RC Remote Control is in the system the unit can be tested by pressing the Test switch on the Ei1529RC. This is equivalent to pressing the Test button on the Alarm. For further information see "ACCESSORIES" on page 32.
3. If the Alarm gives a short beep and the amber fault light flashes every 40 seconds it means the self-

checking circuit has detected a fault. Press and hold the Test/Hush button. If the amber light flashes without the horn sounding, the sensor is faulty. On the Ei261DENRC the display will show **SF** indicating **Sensor Faulty**.

4. If the Alarm fails to operate when the Test/Hush button is pressed, switch off the mains supply at the distribution fuse board and remove unit from mounting plate for 3 minutes. Put unit back on mounting plate. Reconnect the mains and test again. (This procedure resets the microprocessor in the unit).

5. If the unit beeps every 40 seconds (without a light flash) it means the battery is depleted. (On the Ei261DENRC with depleted cells, the display will show **CP** to remind you to **Connect mains Power**). Connect mains power (ensure green light is on) to allow cells to charge.

6. Once a year check the **rechargeable battery** by switching off the mains supply and pressing the Test /Hush button for 10 seconds. The horn should sound loudly. Reconnect the mains supply.

If the CO Alarm fails any of the above tests it must be replaced immediately (see 9 “GETTING YOUR CO ALARM SERVICED” on page 27).

## TESTING WITH CARBON MONOXIDE

The unit checks for CO every 4 seconds and as soon as it detects CO, it flashes the red light (as per Table B on page 8) to confirm that is detecting CO gas.

Alternatively:

Pressing the Test/Hush button causes the unit to check for CO - this is the **Fast CO Test Mode**. This eliminates the long wait normally required (e.g. up to 90 minutes at 55ppm CO and up to 3 minutes at 330ppm CO).

The unit can be tested with CO by using one of the kits that comes with CO either in a glass phial or aerosol can. Follow the instructions on the kit but be sure to press the Test/Hush button to speed up the CO sampling **directly** after you expose the unit to the CO. It is best if possible to inject the CO gas into the gas entry holes (see *Figure 1*). When it senses the CO it will give 3 beeps and the red light will flash as per Table B. It then automatically resets to normal mode. (If unit fails to respond, press the Test/Hush button again as gas can take some seconds to enter sensor).

The **Fast CO Test Mode** normally does not activate the memory function unless a high level of CO remains in the sensor for a few minutes. (This can be checked by pressing the Test/Hush button. If the red light flashes continuously (indicating CO was detected), hold the Test/Hush button for 20 seconds until the red light stops flashing as the memory resets).

## 6. HOW TO DISTINGUISH BETWEEN CO ALARM & SMOKE ALARM WARNINGS

The CO Alarm has a distinctive on-off sound of 3 pulses followed by a pause, as compared with a typical Smoke/Heat Alarm which has a rapid pulsing sound.

In addition, when your CO Alarm is sounding, the red alarm light on the cover will be flashing.

Testing both your CO Alarms and Smoke/Heat Alarms weekly will help you and your family to clearly distinguish between them in an emergency.

If CO Alarms and Smoke/Heat Alarms are interconnected (and are all sounding), press the LOCATE switch on the Ei1529RC Remote Control to leave just the alarm that has triggered the system sounding.

## 7. MAINTENANCE

Clean the outside case by occasionally wiping with a clean damp cloth (disconnect the mains supply at the distribution/fuse board first). Do not use any cleaning agents, bleaches, detergents or polishes, including those in aerosol cans. Avoid spraying air fresheners, hair spray, paint or other aerosols near the CO Alarm. Do not place air fresheners near the unit.

Use the narrow nozzle of a vacuum cleaner to remove dust and other contamination from the gas entry holes in the cover of the Alarm to ensure CO gas can reach the sensor.

### ! Do not paint the CO Alarm.

! Remove the CO Alarm when decorating. Do not allow water or dust to contaminate the alarm.

! Do not open or tamper with the CO Alarm. This can damage the unit and may expose the user to shock or fire hazards. There are no user serviceable parts inside apart from the sensor module - see overleaf.

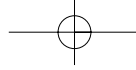

## HOW TO DISCONNECT AND REMOVE THE ALARM:

- (1) Disconnect the mains supply to the CO Alarm circuit at the distribution/fuse board.
- (2) Remove tamperproofing screw if fitted (see *Figure 1*).
- (3) Release catch (as shown in *Figure 1*) and slide unit off mounting plate.

## SENSOR MODULE REPLACEMENT

**Replace the sensor module after 5 years operation (or by the date on the 'REPLACE SENSOR BY' label on the side of the unit).** After 5 years operation, the amber light will flash once every 40 seconds (without a beep) to indicate the sensor should be replaced.

It must also be replaced if the amber light flashes and the unit beeps every 40 seconds as this indicates the sensor is faulty.

- (1) Remove the alarm from the mounting plate as described previously.
- (2) Pull out the sensor module from the rear.
- (3) Replace with a new sensor module (Model No. Ei261MEN - Contact Aico or Ei Electronics, for your nearest module supplier).
- (4) Carefully align the module including the connector pins and push firmly home.
- (5) Remove the 'REPLACE SENSOR BY' label on the side of the alarm.
- (6) Slide the alarm back on to the mounting plate.
- (7) Reconnect the mains supply.
- (8) Wait 4 minutes for the new sensor to stabilise and then press the Test/Hush button - the horn should sound.

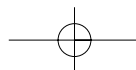

**Note:** When the second sensor has completed its 5 years of operation the amber light will flash every 40 seconds. The sensor module can only be replaced once. **The entire unit must be replaced after 10 years.** The date for replacing the entire unit is given on the 'REPLACE UNIT BY' label on the alarm.

## 8. LIMITATIONS OF CO ALARMS

- The Ei261EN/261DEN CO Alarm will not work without mains power if the rechargeable cells are depleted. The green power light indicates that the Alarm is receiving mains power.
- Carbon Monoxide must enter the unit for it to be detected. There may be Carbon Monoxide in other areas of the house (e.g. downstairs, in a closed room etc) but not in the vicinity of the CO Alarm. Doors, air draughts and obstructions can prevent the CO from reaching the Alarm. For these reasons we recommend CO Alarms are fitted both near and in bedrooms, particularly if bedroom doors are closed at night. Additionally install in rooms where members of the household spend much of their time, and in rooms with potential sources of CO gas.
- The CO Alarm may not be heard. The sound output is loud but it may not be heard behind a closed door or if it is too far away. Interconnecting CO Alarms greatly improves the probability that they will be heard. The Alarm may not wake up somebody who has taken alcohol or drugs. The alarm sound may be masked by other sounds such as T.V., stereo, traffic noise etc. Fitting CO Alarms on either side of closed doors will improve their chance of being heard. This CO Alarm is not designed for people with impaired hearing.
- CO Alarms don't last indefinitely. CO Alarms are sophisticated electronic devices with many parts. Although the alarm and its component parts have undergone stringent tests and are designed to be very reliable, it is possible that parts can fail. Therefore, you should test your CO Alarm weekly. The CO Alarm sensor must be replaced after 5 years operation. The complete unit must be replaced after 10 years.
- CO Alarms are not a substitute for life insurance. House-holders are responsible for their own insurance. The CO Alarm warns of increasing CO levels, but we do not guarantee that this will protect everyone from CO poisoning.



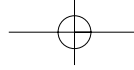

- CO Alarms are not suitable as early warning Smoke Alarms. Some fires produce Carbon Monoxide, but the response characteristics of these CO Alarms are such that they would not give sufficient warning of fire. Smoke Alarms must be fitted to give early warning of fire.
- This CO Alarm does not detect the presence of natural gas (methane), bottled gas (propane, butane) or other combustible gases. Fit combustion gas alarms to detect these.

**WARNING:** THIS CO ALARM IS DESIGNED TO PROTECT INDIVIDUALS FROM THE ACUTE EFFECTS OF CARBON MONOXIDE EXPOSURE. IT WILL NOT FULLY SAFEGUARD INDIVIDUALS WITH SPECIFIC MEDICAL CONDITIONS. IF IN DOUBT CONSULT A MEDICAL PRACTITIONER.

## 9. HOW TO PROTECT YOUR FAMILY

Follow these guidelines to reduce the risk of Carbon Monoxide poisoning.

- Know and look out for tell-tale signs that Carbon Monoxide may be present. These include:-
  - The CO Alarm warning of abnormal levels.
  - Staining, sooting or discolouration on or around appliances.
  - A pilot light frequently going out.
  - A naked gas flame which is yellow or orange, instead of the normal blue.
  - Family members (including pets) exhibiting the “flu-like” symptoms of CO poisoning (described in Table B on page 8).

If any of these signs are present get the appliance checked out by an expert before further use. If family members are ill, get medical help.

- Choose all appliances and vehicles which burn fossil fuels such as coal, oil, natural/bottled gas, paraffin, wood, petrol, diesel, charcoal etc. with care and have them professionally installed and regularly maintained.

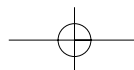

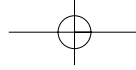

- These appliances must “breathe in” air to burn the fuel properly. Know where the air comes from and ensure vents/air bricks etc. remain unobstructed (particularly after building work).
- The appliances must also “breathe out” the waste gases (including the CO) – usually through a flue or chimney. Ensure chimneys and flues are not blocked or leaking, and get them checked every year. Check for excessive rust or cracks on appliances and pipe work.
- Never leave your car, motor bike or lawnmower engine running in the garage with the garage door closed. Never leave the door from the house to the garage open if the car is running.
- Never adjust your own gas pilot lights.
- Never use a gas cooker or a barbecue for home heating.
- Children should be warned of the dangers of CO poisoning and instructed never to touch, or interfere with the CO Alarm. Do not allow small children to press the Test/Hush button as they could be subjected to excessive noise when the unit alarms.
- Leaving windows or doors slightly open (even a few inches) will significantly reduce the risk of high levels of CO occurring. The high levels of draught-proofing in modern houses reduces ventilation and can allow dangerous gases to build up.
- Install CO Alarms in all the areas recommended in this leaflet.
- Recognise that CO poisoning may be the cause when family members suffer from “flu-like” symptoms when at home but feel better when they are away for extended periods.

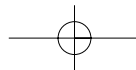
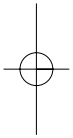
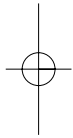

## 10. GETTING YOUR CO ALARM SERVICED

If your CO Alarm fails to work after you have carefully read all the instructions, checked the unit has been installed correctly, and is receiving AC power, return it for repair or replacement. (Do not attach to mounting plate as unit can give beeps or alarm if the Test/Hush button is pressed during shipping). It should be returned in a padded box to “Customer Assistance and Information” at the nearest address given on the back page. State the nature of the fault, where the CO Alarm was purchased, and the date of purchase.

## 11. FIVE YEAR GUARANTEE

Ei Electronics guarantees this Carbon Monoxide Alarm for five years from the date of purchase against any defects that are due to faulty materials or workmanship. This guarantee only applies to normal conditions of use and service, and does not include damage resulting from accident, neglect, misuse, unauthorised dismantling, or contamination howsoever caused. This guarantee excludes incidental and consequential damage. If this Carbon Monoxide Alarm should become defective within the guarantee period, it must be returned to the nearest address given on the back page, carefully packaged, with the problem clearly stated (see 9 “GETTING YOUR CO ALARM SERVICED”) along with proof of the date of purchase. We shall at our discretion repair or replace the faulty unit.

## 12. TECHNICAL SPECIFICATIONS

Operating Voltage	: 230±10% VAC, 50Hz
Power	: 1 Watt (60 mA)
Power on Indicator	: Green Light
Sensor	: Electrochemical Sensor
CO Sensitivity	: Meets BS EN 50291: 2001. Unit operates as per Table B (on page 8).
Electrical Safety	: Complies with relevant sections of EN 60335-1: 1994
Electromagnetic Compatibility	: Complies with BS EN 50270
Test/Hush Button	: Checks electronics and horn.  When the unit is alarming, after sensing CO, pressing the Test/Hush button will immediately stop the horn (the red light will continue to flash). If CO is still present the red light and the horn will turn on again after about 4 minutes. The unit can only be silenced once during a CO incident. At 300 ppm CO the unit cannot be silenced. (With interconnected units, the Hush only works on the alarm sensing CO).
Fast CO Test Mode	: Pressing the Test/Hush button also causes the unit to check for CO 4 seconds later to facilitate testing in CO gas. It gives 3 beeps and the red light flashes to indicate the CO level if CO is sensed and then resets.

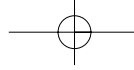

- Initialisation Time : 70 seconds. On power up red and amber lights flash momentarily to show they are operational.
- Operating Temperature : -10°C to 40°C
- Humidity Range : 15% to 95% R.H. (non-condensing)
- Audible Alarm : 85dB(A) minimum @ 3m
- Self Diagnostics : Horn beep and amber fault light flashes every 40 seconds if a sensor fault is found.
- Tamperproof : Screwdriver needed to release from mounting plate. Additionally a tamper-proofing screw can be fitted to the mounting plate.
- Rechargeable Lithium Cells: : Fully charged cells can power unit in standby for over 4 weeks and without mains power, it can power the unit in alarm for over 2 hours. The unit beeps every 40 seconds if cells are depleted.
- Interconnect : Up to 12 Ei261ENRC/261DENRC CO Alarms can be interconnected, so that when one senses CO, all alarm. Alternatively, up to 12 Ei261ENRC/Ei261DENRC CO Alarms and Ei161RC/Ei164RC/Ei166RC Smoke/Heat Alarms can be interconnected provided that an Ei1529RC Remote Control is used.
- Relay Module Ei128RBU with Ei128COV (optional) : This can be connected using the interconnect line.

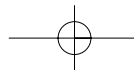
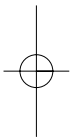
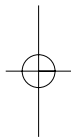

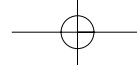

CO Alarm Memory: : A unit will indicate if it has been in alarm previously by flashing the red light for 2 seconds every 40 seconds (2 flashes for 50 ppm CO, 4 flashes for 100 ppm CO and 8 flashes, for 300 ppm CO). When the Test/Hush button is pressed, the red light flashes (as per Table B on page 8) to indicate the previous CO alarm level detected. The memory is cleared by holding down the Test/Hush button until the red light stops flashing.

Digital Display (Ei261DENRC only) : Range 50 - 300ppm CO  
Resolution 5 ppm CO  
With low rechargeable cells - **CP**  
With sensor faulty - **SF**  
With Test/Hush button pressed - previous peak CO level

Dimensions : 126 x 150 x 42 mm.

Weight : 330g.

## 13. TROUBLESHOOTING

### 1. ALARM DOES NOT WORK WHEN THE TEST BUTTON IS PRESSED:

- Check that the green mains power light is on. If it is off check the wiring, fuse, circuit breakers etc.
- Hold the Test/Hush button down for at least 5 seconds.

### 2. ALARM BEEPS AND AMBER LIGHT FLASHES EVERY 40 SECONDS:

- If the alarm beeps and the amber fault light flashes every 40 seconds, the CO sensor is probably defective.

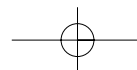

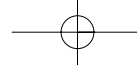

- Press the Test/Hush button for approximately 20 seconds to reset the unit. If the beeping and the amber light flashing re-occurs replace the sensor module.

### **3. ALARM BEEPS EVERY 40 SECONDS** (without amber light flashing):

- Rechargeable cells depleted. Reconnect mains power if green light is off.

### **4. ALARM SOUNDS FOR NO APPARENT REASON:**

Follow the detailed instructions in Section 1 on page 5 entitled “WHAT TO DO WHEN THE ALARM SOUNDS”. If there are still problems:

- Ensure there are no fuel-burning appliances in the vicinity which could be leaking CO gas (e.g. even from next door).
- Ensure there are no fumes in the area (e.g. paint, thinners, alcohol, hair spray, chemical cleaners aerosol sprays etc).
- Ensure there is no outdoor source of CO in the vicinity (e.g. a car with engine running, heavy traffic, heavy air pollution, barbecue fumes etc).
- Press the Test/Hush button to silence the alarm.

If the unit continues to sound it is possibly defective and should be replaced. Follow the instructions in Section 9 “GETTING YOUR CO ALARM SERVICED”.

### **4. Test/Hush BUTTON DOES NOT SILENCE ALARMS:**

If there are a number of alarms interconnected and they are all sounding, pressing the Test/Hush button on the unit sensing CO (i.e. the one with the red light flashing) will silence the system. Pressing any other Test/Hush button will not silence the alarms. The Test/Hush button will only silence the unit once at CO levels less than 300 ppm CO during a CO incident.

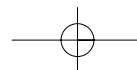

Alternatively, if an optional Ei1529RC Remote Control is fitted, pressing the LOCATE switch when all alarms are sounding will silence all alarms apart from the alarm that is sensing CO/Smoke/Heat.

This area can then be safely investigated and if determined that it is a false alarm, press the HUSH switch to silence the alarm.

## 14. ACCESSORIES



### Ei1529RC Remote Control

The Ei1529RC is strongly advised for systems with interconnected CO and Smoke/Heat Alarms.

It allows the user to perform the following functions from a remote location.

- Locate** - When system sounds press **Locate** to allow the source of alarm to be identified
- Hush** - Press **Hush** to silence nuisance alarms
- Test** - Operate weekly to **Test** the alarm system
- Mains Check** - **Test** will not work with mains absent



### Ei128RBU Relay Module with Ei128COV Cover

The Ei128RBU module has a relay rated at 230VAC / 5Amps. It is mains powered with rechargeable battery back-up. It can be used for remote signalling and activating gas shut-off valves, strobes etc.



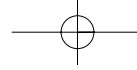

The crossed out wheelie bin symbol that is on your product indicates that this product should not be disposed of via the normal household waste stream. Proper disposal will prevent possible harm to the environment or to human health. When disposing of this product please separate it from other waste streams to ensure that it can be recycled in an environmentally sound manner. For more details on collection and proper disposal, please contact your local government office or the retailer where you purchased this product.

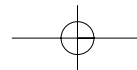
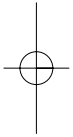
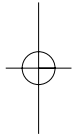

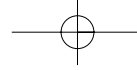

### **Aico Ltd**

Mile End Business Park, Maesbury Rd,  
Oswestry, Shropshire SY10 8NN, U.K.

Tel: 0870 758 4000

**[www.aico.co.uk](http://www.aico.co.uk)**

### **Ei Electronics**

Shannon, Co Clare, Ireland.

Tel: +353 (0)61 471277

**[www.eielectronics.com](http://www.eielectronics.com)**

