60cm Integrated Turbo Extractor

LAM2201



User & Installation Guide

LAMONA

Exclusive to Howdens Joinery Co.

Dear Customer,

Congratulations on your choice of domestic appliance which has been designed to give you excellent service.

The user manual will help you use your product quickly and safely.

- Please read this user manual before installing and using the product.
- Always follow the safety instructions.
- Keep this user manual within easy reach for future reference.
- Please read any other documents supplied with the product.

Explanation of symbols

Throughout this user manual the following symbols are used:



Important information or useful tips about usage.



Warning for possible hazards to health and property.



Warning possibility of electric shock.



This product's packaging material is recyclable. Help recycle it and protect the environment by dropping it off in the municipal receptacles provided for this purpose. Your product also contains a great amount of recyclable material. It is marked with this label to indicate the used appliances that should not be mixed with other waste. This way, the appliance recycling organised by your manufacturer will be done under the best possible conditions, in compliance with European Directive 2002/96/EC on Waste Electrical and Electronic Equipment. Contact your town hall or your retailer for the used appliance collection points closest to your home. We thank you doing your part to protect the environment.

Index

Before using the extractor	04
Safety	04
General	04
Fire Saftey	05
Safety for children	05
Safety when working with electricity	05
General information & operation	06
Extractor layout	06
Control panel layout	06
Using Your Cooker Hood	07
Care and maintenance	08
General Cleaning	08
Grease Filters	08
Charcoal Filters	09
Replacing the Lamps	09
Installation	10
Methods of extraction	10
Extraction Via Ducting	10
Extraction Via Recirculation	10
Before beginning instalation	11
Installing your cooker hood	11
Connecting to external ducting	12
Electrical Connections	13
Technical specification	14
Troubleshooting	15
Your Guarantee	16

Before using the Extractor

- Make sure that you have removed all packaging, wrappings, stickers and films from the Extractor
- It is recommended that you clean the extractor's surface before using for the first time.

Safety

 This appliance is for domestic extraction purposes only. It must not be used for other purposes. Commercial use will void the guarantee.

The manufacturer shall not be liable for any damage caused by improper use, installation or handling errors

General

This product is not intended to be used by persons with physical, sensory or mental disorders or unlearned or inexperienced people (including children) unless they are supervised by a person who will be responsible for their safety or who will instruct them accordingly in the use of the product.

- Connect the product to an earthed outlet protected by a fuse of suitable capacity as stated in the "Technical Specifications" table. Our company shall not be liable for any problems arising due to the product not being earthed in accordance with the local regulations.
- Do not operate the product if the power cable is damaged. Call qualified service agent.
- Do not carry out any repairs or modifications on the product. However, you may remedy some of the problems that do not require any repairs or modifications. See Troubleshooting, at the rear of this manual.
- Never wash down the product with excessive water, as there is the risk of electric shock!
- Never use the product when your judgment or coordination is impaired by the use of alcohol and/or drugs.
- Product must be disconnected from the mains during installation, maintenance, cleaning and repair procedures.
- Repair procedures must always be performed by qualified service agents. The manufacturer shall not be held responsible for damages arising from procedures carried out by unauthorised persons, which may also void the guarantee.
- Keep all ventilation slots clear of obstructions, as this may cause premature failure of the appliance
- Do not trap the mains cable and do not route it over surfaces which may become hot. The cable insulation may melt and cause a fire as a result of a short circuit.
- Make sure that the product function buttons are switched off after every use.
- Product must be installed by a qualified person in accordance with the regulations in force otherwise, the guarantee may become void.
- The hood must be installed in accordance with the installation instructions and all measurements followed.
- If the cooker hood is installed for use above a gas appliance then the provision for ventilation must be in accordance with the Gas Safety Codes of Practice BS.6172, BS.5440 & BS.6891 (Natural Gas) and BS.5482 (LP Gas) 1994, the Gas Safety (Installation & Use) Regulations, the Building Regulations issued by the Department of the Environment, the Building Standards (Scotland) (Consolidated) Regulations issued by the Scottish Development Department.

 **Do not set your cooker hood less than 700mm above your cooker.**

- When installed between adjoining wall cabinets, the cabinets must not overhang the hob.
- The edges of the cooker hood may be sharp be mindful of this as you handle your appliance, especially during installation and cleaning.

 **Do not clean behind the grease filter!**

- If the room where the cooker hood is to be used contains a fuel burning appliance such as a central heating boiler then its flue must be of the sealed or balanced flue type.
- If other types of flue or appliances are fitted, ensure that there is an adequate supply of air in the room.
- When the hood is being used in extraction mode, ensure that the ducting is fire retardant and that there are no bends greater than 90 degrees as this will reduce the efficiency of the hood.
- Ensure the ducting for the extractor mode has the same diameter as the outlet hole all the way through.
- Always put lids on pans and ensure that pans are always on hobs when burners are lit.
- Remember that when in extraction mode, your cooker hood is removing air from your room. Ensure that proper ventilation measures are being observed.

Fire Safety

When installing the hood, ensure that the following recommended distances are observed between the highest point on the hob top (including the burners) and the bottom of the cooker hood:

Electric cookers: 700 mm
Gas cookers: 700 mm
Coal / oil cookers: 800 mm

- Never flambé cook under this cooker hood.
- Dirty cooking oil is an even greater fire risk.
- Do not install above a cooker with a high level grill.

Safety for children

- Electrical products can be dangerous to children. Keep children away from the product when it is operating and do not allow them to play with or near the product.
- The packaging materials will be dangerous for children. Keep the packaging materials away from children. Please dispose of all parts of the packaging according to environmental standards.

Safety when working with electricity

- In case of any damage, switch off the product and disconnect it from the mains. To do this, turn off the fuse at the fuse box.
- Make sure that fuse rating is compatible with the product.

General Information & operation

Extractor layout

- | | |
|---------------------------------|------------------|
| 1. Exhaust / Recirculation vent | 4. Wall cabinets |
| 2. Cabinet door / fascia | 5. Light |
| 3. Air Intake | 6. Control panel |

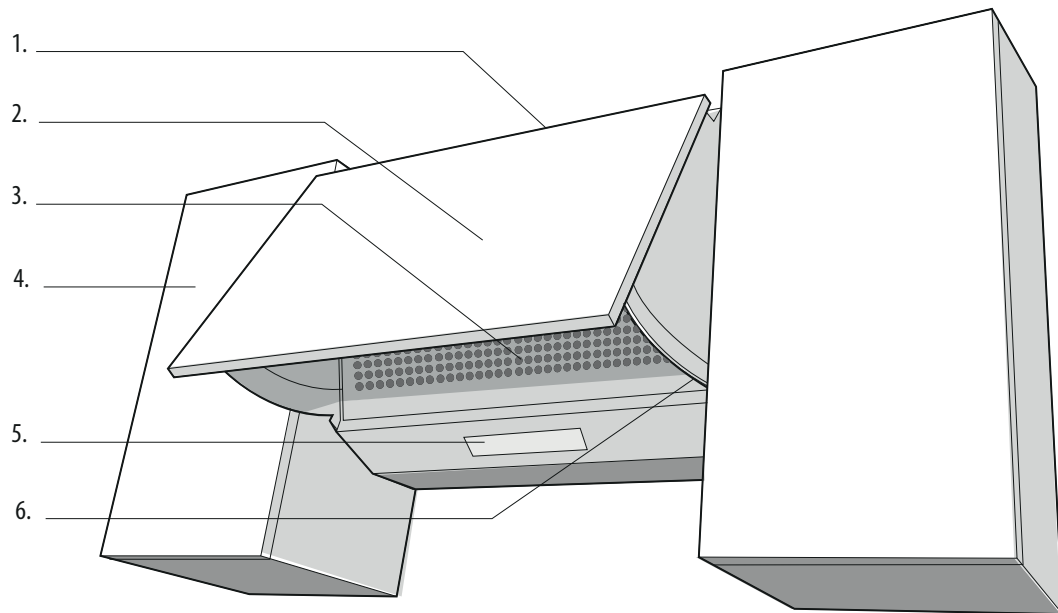

Control panel layout

A microswitch **S** activated by movement of the front panel turns the lighting system on and off and activates switching on and off of the motor at the pre-selected speed.

- | |
|---|
| 1. SWITCH L = Motor ON/OFF Slider |
| 2. SWITCH M = Light ON/OFF Slider |
| 3. SWITCH V = Speed Control Slider |

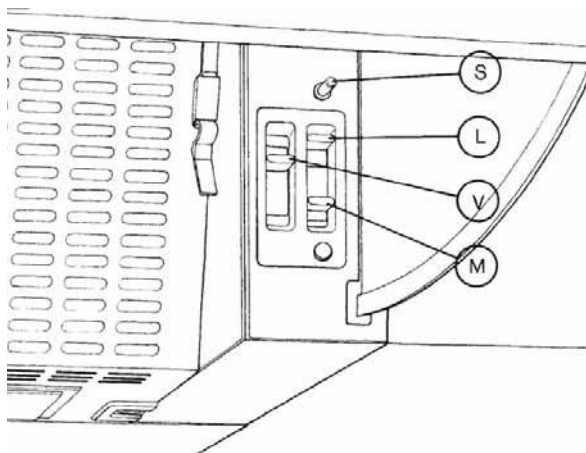

Using Your Cooker Hood

This process must be followed before the cooker hood is used for the first time. You should clean the appliance using a damp new cloth and warm soapy water before using the appliance for the first time. You should then dry it thoroughly using a soft cloth.

Make sure that it has been installed by a suitably qualified person, as per the installation instructions.

To use your cooker hood

- The control panel can be located by opening the front panel and looking to the right hand side of the cooker hood.
- There are three sliders on the control panel, which perform separate functions.

1. Motor ON/OFF Slider

0 = Motor Off
1 = Motor On

2. Speed Control Slider

1. Low speed
2. Medium speed
3. High speed

3. Light ON/OFF Slider

0 = Light off
1 = Light on

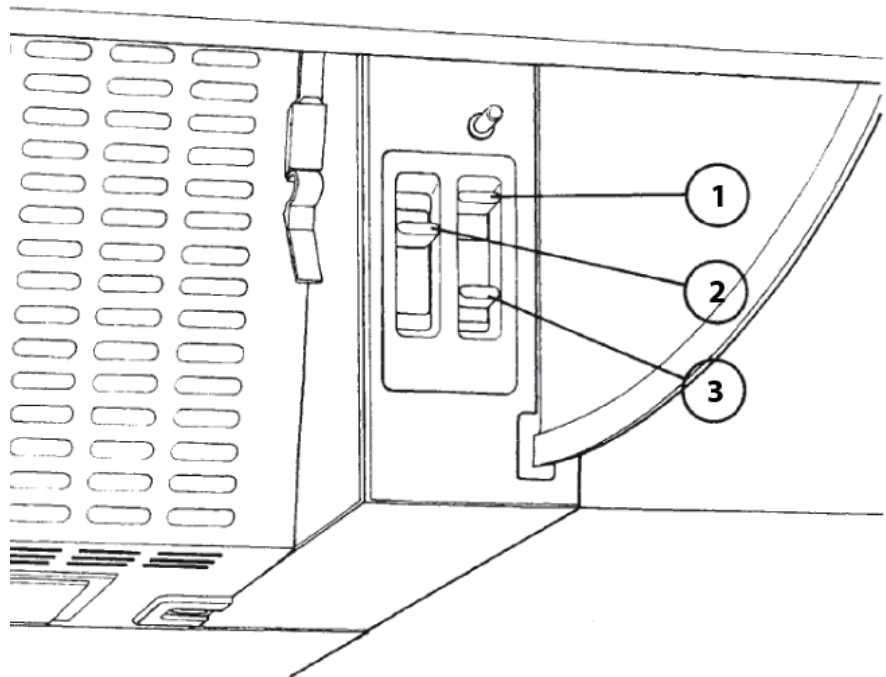

⚠ Ideally you should turn on your hood ten minutes before you start to cook, or at the very least when you begin cooking. You should also run your hood for ten minutes after you have finished cooking.

Care and maintenance

⚠ Before cleaning or attempting any type of maintenance, always make sure that the electricity supply is disconnected.

To avoid the possibility of fire, adhere strictly to all of the recommendations included in this booklet, paying particular attention to the grease filters to ensure grease deposits do not build up.

The manufacturer declines all liability in cases where the instructions for the appropriate installation, maintenance and use of the extractor hood are not observed.

If the power cable is cut or damaged in any way, disconnect the extractor from the electricity supply and call the service number on the rear cover of this booklet or a suitably qualified repairer.

General Cleaning

Wipe the external surfaces of the appliance regularly using warm water and a mild detergent. NEVER use abrasive cleaners.

The Grease Filters

Your cooker hood includes a grease filter which helps to absorb grease from cooking to protect your kitchen and furniture from greasy residues.

The filter may become flammable if it becomes saturated with this greasy residue.

To prevent this fire hazard, the filter should be cleaned or replaced regularly. Depending on use, this should be done probably at least once a month, * using hot water and normal washing-up detergent.

(* Depending upon the type of grease sheet filter used)

1. To access the grease filter, remove the metal grille by push the two catches towards the centre while pulling downwards
2. Take out the grease filter by removing the flexible wire retainers
3. Soak the grease filter in hot water and washing up liquid for about an hour. (* If not washable- replace filter instead)
4. Rinse it off thoroughly with hot water.
5. Repeat the process if required.
6. Refit the grease filter once it has dried.
7. Close the front cover.

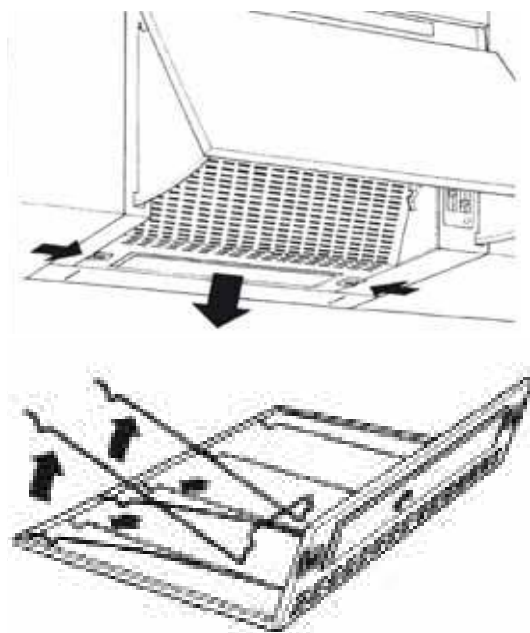

You should wipe over the front panel with a damp cloth and hot soapy water, then dry it thoroughly with a soft cloth.

The Charcoal Filters

If the appliance is going to be used in recirculation mode then it is necessary to fit carbon filters. This will help to absorb odours caused by cooking.

Charcoal filters have a limited life. We advise you to change them when there is a noticeable drop in performance. The intervals between changing the filter will depend entirely upon the amount of cooking you do, but on average they will last about 6 months.

- To gain access to the carbon filters, first of all remove the grease filters as detailed on the opposite page.
- Replace the old filter by unscrewing the fixing knob as detailed below and close the metal grille.

(LAM2000 - pack of 2).

Replacing the Lamps

The extractor hood is fitted with two 28W E14 Halogen lamps that may need to be replaced periodically.

To do this, ensure that the power is switched off and the lamps have had time to cool.

- Remove the grease filters to gain access.
- Unscrew the lamps and replace with new lamps of the same type and wattage.

⚠ Lamp replacement is not covered by your guarantee

The lamps on this appliance should only be used during operation of the cooker hood. They should not be left on permanently.

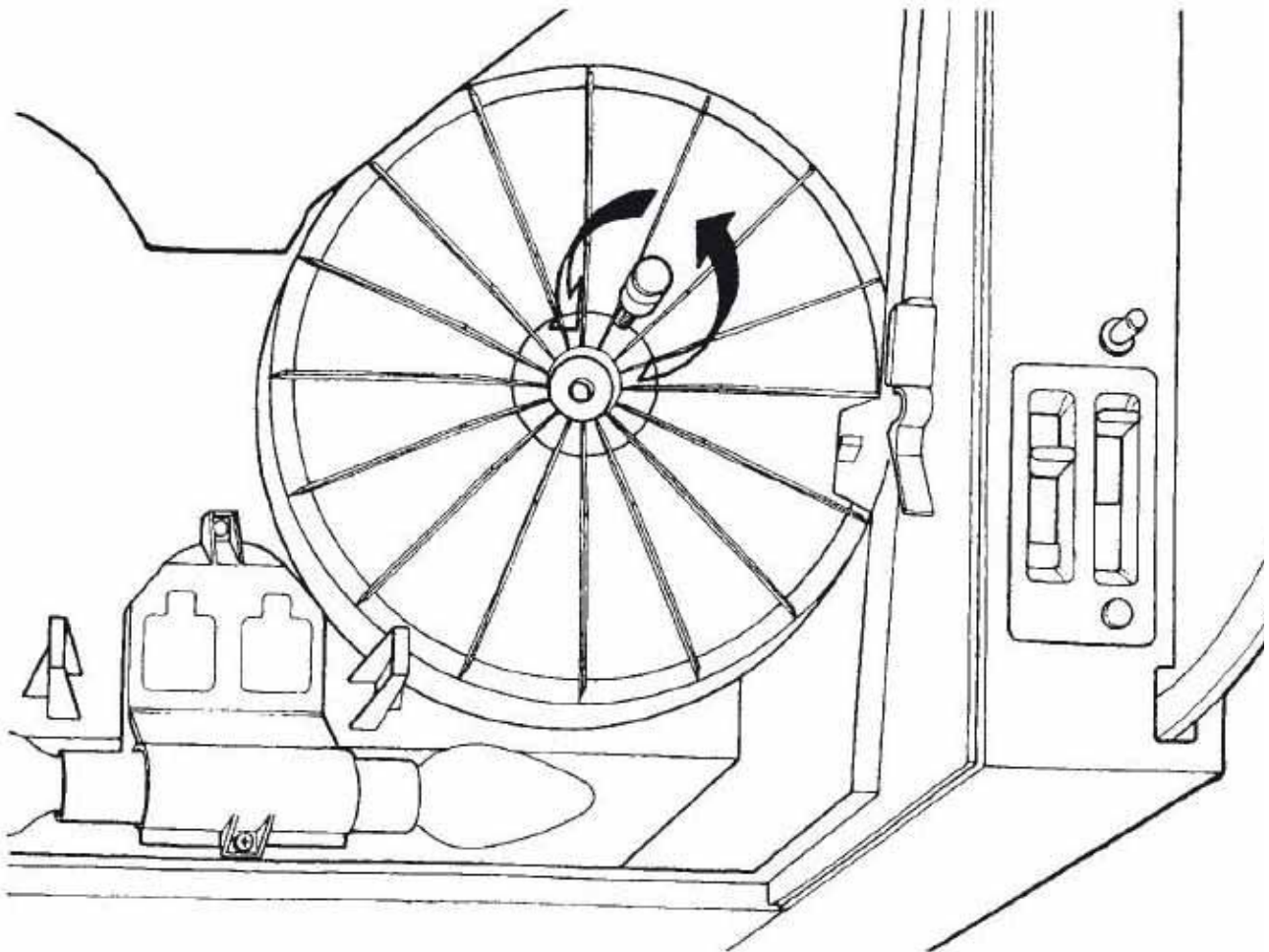

Installation

Methods of Extraction

The very best method of clearing the kitchen of unwanted odours is by connecting the appliance to an exhaust duct and venting to the outside atmosphere via the ceiling or an exterior wall. (Suitable ducting kits may be purchased from the depot where you bought the extractor.) You do not need charcoal filters when using the external ducting mode.

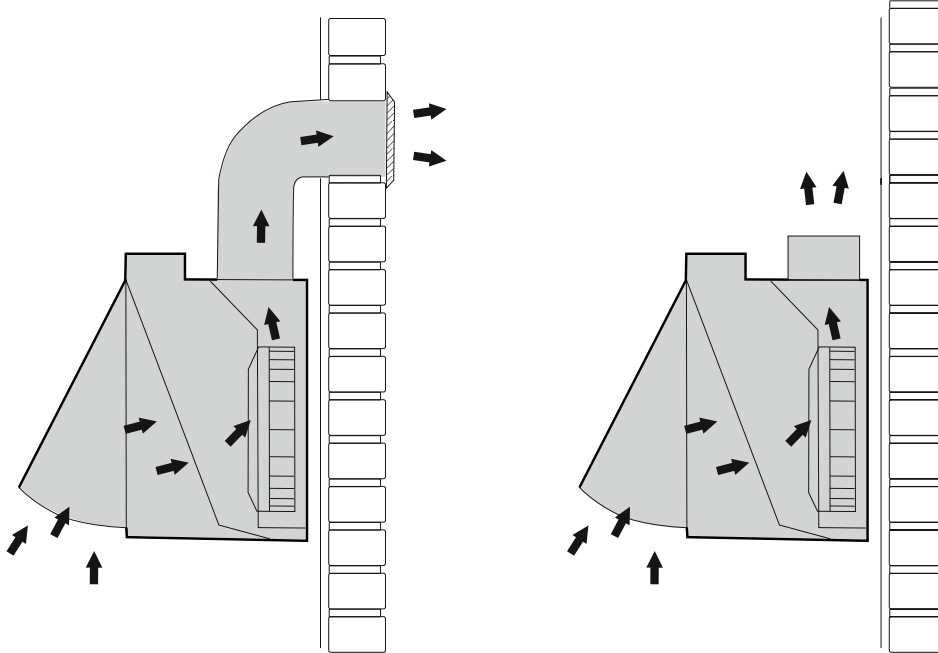

Extraction Via Ducting

Never use the hood in areas where devices with exhaust pipes connected to the outside are already operating unless perfect ventilation can be guaranteed.

- Connect the external ducting kit to the outlet of the extractor.

 Charcoal filters are not required if the extractor is to be ducted out.

Extraction Via Recirculation

For extraction via recirculation, attach 2 charcoal filters to the sides of the motor inside the hood. (Part reference LAM2000)

 **Before attempting to change or fit the charcoal filters ensure power to the extractor is switched off.**

- Remove the metal grille by pushing the catches towards the centre while pushing downwards.
- Remove the existing filter by unscrewing the fixing knobs and removing.
- Insert replacement filter and fix in position using the fixing knob.
- Return metal grille before the power supply is turned back on.

Before beginning installation

- Check that the product purchased is of a suitable size for the chosen installation area. In addition check whether there is an electrical socket available that will be accessible once the hood is mounted. If the product is going to be used in extraction mode, then there should also be space to connect a ducting hose to the outside.
- Carry out all necessary masonry work prior to the fitting of the cooker hood.
- Ensure that all electrical connections are carried out by a suitably qualified person.
- Before commencing installation of the cooker hood the grease filter should be removed.
- Check inside the product and ensure that there is no transit packaging or any other materials, such as packets of screws, guarantees etc. These should be removed and kept for future use.
- If possible, disconnect and move freestanding or slot-in cookers from their position, to provide easier access to the rear wall and cupboards. If this is not possible, then a thick, protective covering should be placed over the worktop, hob top or cooker. This will help to protect these surfaces from damage and debris.
- Select a flat surface for assembling the cooker hood. Cover that surface with a protective covering and place all cooker hood parts and fittings on it.
- Do not tile, grout or silicone this appliance to the wall or cabinetry. This appliance is designed to be surface mounted only.

Installing your cooker hood

⚠ You will have to decide before installing your cooker hood whether to use it in extraction mode or recirculation mode.

We recommend that at least two people install this hood.

Your cooker hood should only be fitted to a wall and secured between two cupboards.

It must be positioned at least 700mm above the hob underneath it. This measurement should be taken from the highest point on the hob, including the burners.

⚠ Your cooker hood should only be connected to the mains power supply after the rest of the installation process has been completed.

1. Fixing the front panel to the screen

Extract the metal screen by turning it outwards unlocking, at the same time the stop on the left hand side of the hood (fig. 1), drill the panel, using the cardboard template provided and fix it to the screen using the 3.9 x 13 screws provided. Replace the screen, ensuring that the guides are fitted correctly into position. Adjust the slide of the screen by turning the two screws.

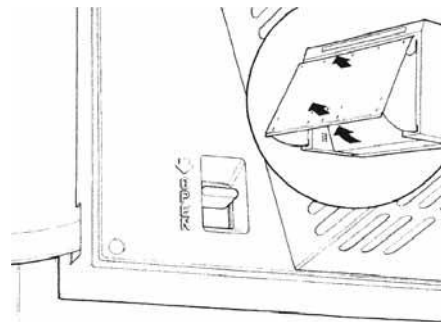

1

2. Fixing to the wall

Drill the wall using the cardboard template provided, fit plugs into the holes and fix the two metal brackets using the four screws provided with the accessories. Hook the hood onto the metal brackets. The rear hooks on the hood can be adjusted both in height and depth, allowing the hood to be aligned with the cupboards on either side (fig. 2). In some models the rear hooks can only be adjusted horizontally (fig. 3), in any case, after hooking the hood to the wall it will always be necessary to adjust the depth of the metal

spacer on the lower part of the hood (**fig. 4**)

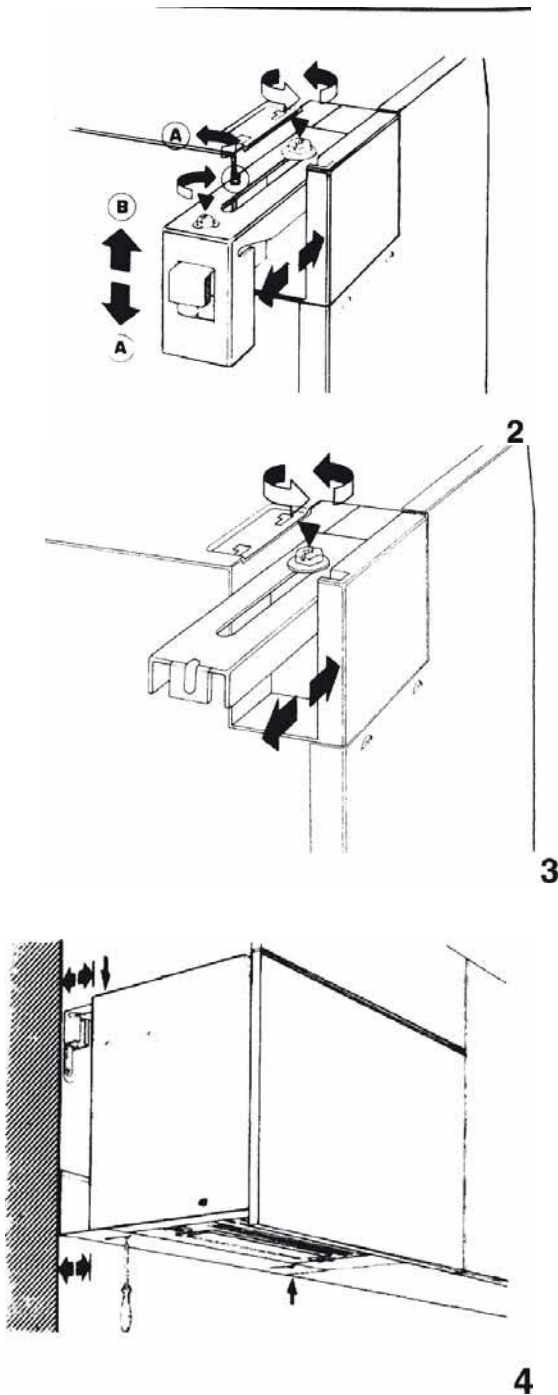

3. **Fixing to cupboards on either side**
Drill the side cupboards using the cardboard template provided, remove the screen. Remove the ventilator grille (**fig. 5**), fix the hood to the cupboards using the 3.5 x 16 screws provided screwing them from the inside (**fig. 6**).

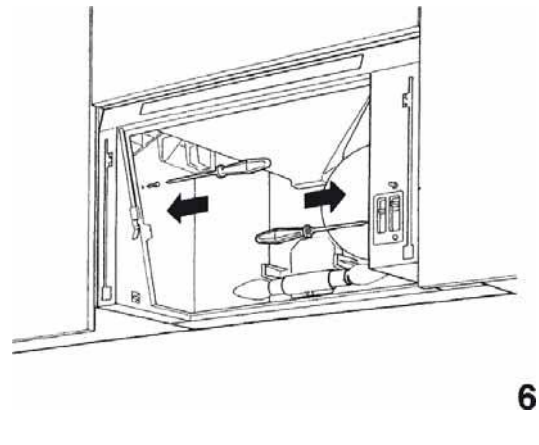
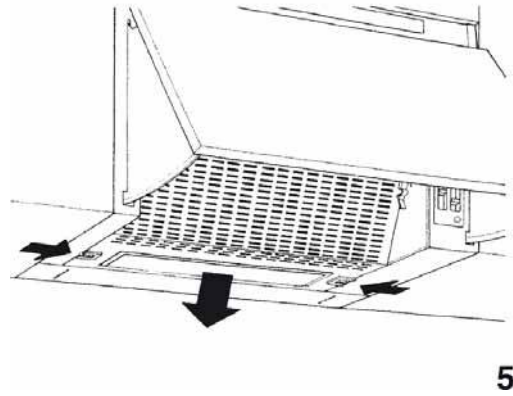

Connecting to external ducting

- Connect the coupling to the top or the rear of the cooker hood, and then connect a 125 mm ducting hose to the coupling (please note that the ducting hose is not supplied with the appliance).
- You may find an anti-draft flap included with the fixtures and fittings for the cooker hood. You should sit this in the top of the coupling.
- If you use the rear or top venting position, the other one should be blocked off using the blanking plate supplied.
- The other end of the ducting hose should be connected to a discharge outlet that is suitable for cooking vapours. It should have a cross section of at least 150 cm².
- The maximum distance between the coupling and your discharge outlet should be 3 metres, with one 90 degree bend.

Electrical Connections

⚠ IMPORTANT: Ensure that the electricity supply is switched off before connecting. Your Extractor is intended for permanent installation.

Your appliance must be connected to fixed wiring via the use of a double pole switched fused spur outlet with at least 3mm contact separation, The isolation switch must be accessible after installation. (See technical data for fuse rating).

We strongly recommend the appliance is connected by a qualified electrician who will comply with the I.E.E and any local regulations.

⚠ The terminology DOUBLE POLE means that both the live and neutral supplies are switched and disconnected at the same time.
The terminations labelled SUPPLY are the connections for the internal house wiring and the terminations labelled LOAD are for connection to the appliance.

IMPORTANT: The wires in the mains lead are coloured in accordance with the following code:-
Blue.....Neutral
Brown.....Live

As the colours of the wires in the mains lead of this appliance may not correspond with the coloured markings identifying the terminals in your spur box, proceed as follows;

The wire which is coloured blue must be connected to the terminal which is marked with the letter 'N' or coloured BLACK. The wire which is coloured brown must be connected to the terminal which is marked with the letter 'L' or coloured RED.

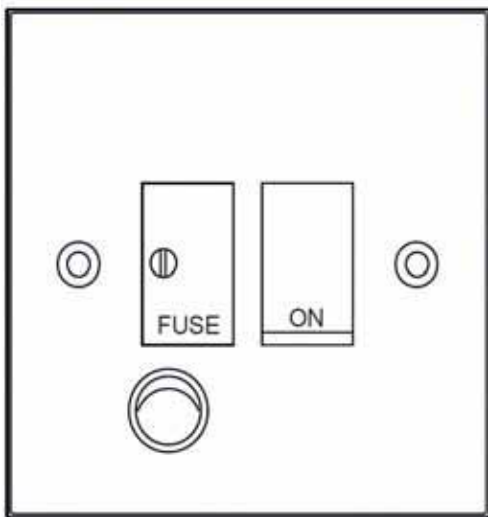

Fig 3.

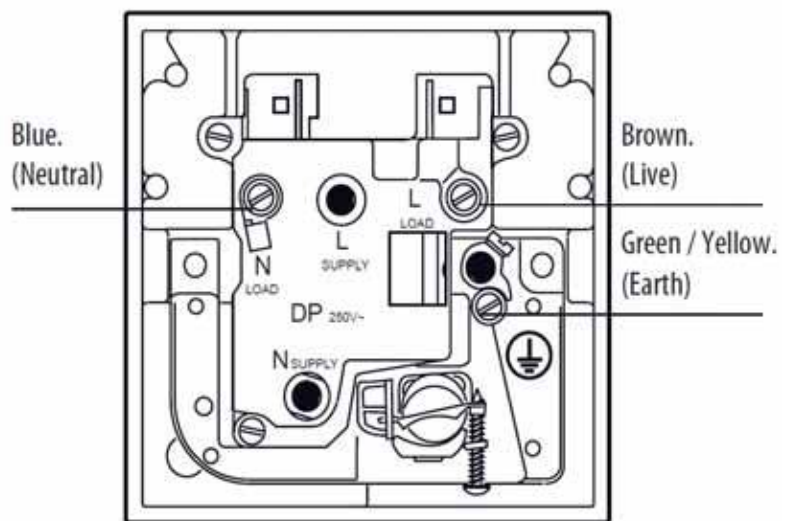

Fig 4.

Technical specification

TECHNICAL INFORMATION

Dimensions:

Width	(canopy):	600mm
Depth	(canopy):	270mm
Height	(canopy):	350 mm

Your Cooker Hood is fitted with:

Single / Twin motor

Slider Control Operation

3 Speeds

(LAM2201)

2 lamp (28w E14 halogen)

1 Synthetic grease filter

Extraction capacity: 290 m³/hr

Noise level min/max: 56 □ 67 dB

Optional Extras:

Charcoal filter: LAM2000 (PK2)

Ducting kits: APL 2805/6/7

Troubleshooting

TROUBLESHOOTING GUIDE

Symptoms	Possible Cause	Solutions
Lamps fail to operate?	<ul style="list-style-type: none"> A replacement lamp is probably necessary, but first check that the lamp is correctly fitted into its holder. <p>(Remember that the lamps are not covered by the guarantee.)</p>	<p>Disconnect the mains electricity supply before adjusting or replacing the lamps.</p> <p>The extractor lamps may become hot; therefore ensure the bulb has cooled sufficiently before replacing.</p>
	<ul style="list-style-type: none"> Power is cut. 	<p>Check if there is power. Check the fuses in the fuse box. If necessary, replace or reset the fuses.</p>
Motor is on but fan does not seem to be as efficient as usual?	<ul style="list-style-type: none"> Clogged filters can reduce the product's efficiency. Check the grease and charcoal filters (if fitted) also ensure any venting is not obstructed? 	<p>Clean the grease filters with warm water and mild detergent, and/or replace any charcoal filters</p>
The extractor works normally but smells linger?	<ul style="list-style-type: none"> Clogged filters can reduce the product's efficiency and may cause unwanted smells. 	<p>Clean the grease filters with warm water and mild detergent, and/or replace any charcoal filters.</p>
Product does not operate?	<ul style="list-style-type: none"> The mains fuse maybe defective or has tripped 	<p>Check fuses in the fuse box. If necessary, replace or reset them.</p>
	<ul style="list-style-type: none"> Product is not connected properly. 	<p>Check all power connections.</p>



If you cannot eliminate the problem after following the instructions in this section, consult your depot or the Authorized Service Agent. Never try to repair a nonfunctional product yourself.

Your guarantee

Product Guarantee Details (UK only)

Your appliance has the benefit of a comprehensive manufacturer's guarantee which covers the cost of breakdown repairs. (Details of which are shown on your Proof of Purchase Document).

- Any claim during the period of the guarantee (MUST BE ACCOMPANIED BY THE PROOF OF PURCHASE)
- The product must be correctly installed and operated in accordance with the manufacturer's instructions and used for normal domestic purposes.
- This guarantee does not cover accidental damage, misuse or alterations which are likely to affect the product.
- The guarantee is invalid if the product is tampered with, or repaired by any unauthorised person.

(The guarantee in no way affects your statutory or legal rights)

What to do if you need to report a problem-

Please ensure you have ready:

- **The product's model & serial numbers**
- **Howdens Proof of Purchase document**
- **Your full contact details**



Call the Service Line on 0845 00 60 006



If supplied, please stick your self adhesive product rating plate here, or make a note of the product serial number below in the box below for future reference.

Serial Number :

Issue: V1 20-07-15 LH



HOWDENS JOINERY CO.

MAKING SPACE MORE VALUABLE



This brochure is printed on FSC certified paper