

INSTRUCTION MANUAL

OPERATING AND INSTALLATION

DT20RF PROGRAMMER

DIGISTAT - Radio frequency controlled room thermostat
with twin channel digital programmer

FOR GREENSTAR CDi, GREENSTAR i JUNIOR AND GREENSTAR Si MODELS
ALSO GREENSTAR i SYSTEM AND GREENSTAR CDi SYSTEM MODEL
(ONLY WHEN USED WITH THE OPTIONAL INTEGRAL DIVERTER VALVE)

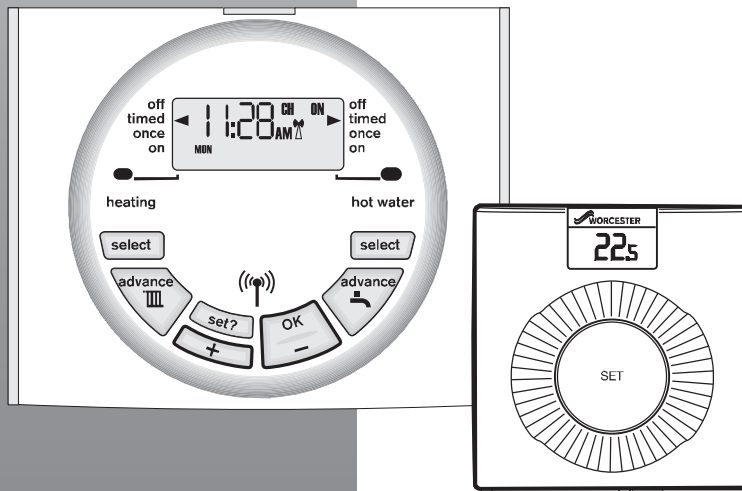

UK/IE

 **WORCESTER**
Bosch Group

MANUAL INFORMATION

WORCESTER, BOSCH GROUP:

TECHNICAL	08705 266241
SERVICE	08457 256206
SPARES	01905 752571
LITERATURE	01905 752556
TRAINING	01905 752526
SALES	01905 752640
WEBSITE	worcester-bosch.co.uk

PLEASE READ THESE INSTRUCTIONS CAREFULLY BEFORE STARTING

THESE INSTRUCTIONS ARE APPLICABLE TO THE WORCESTER BOSCH MODEL(S) STATED ON THE FRONT COVER OF THIS MANUAL ONLY AND MUST NOT BE USED WITH ANY OTHER MAKE OR MODEL



THESE INSTRUCTIONS APPLY IN THE UK ONLY AND SHOULD BE FOLLOWED EXCEPT FOR ANY STATUTORY OBLIGATION

IF YOU ARE IN ANY DOUBT CONTACT WORCESTER BOSCH TECHNICAL HELPLINE

THIS ACCESSORY MUST BE FITTED BY A COMPETENT PERSON. FAILURE TO COMPLY COULD LEAD TO PROSECUTION.

LEAVE THESE INSTRUCTIONS WITH THE USER OR AT THE APPLIANCE.

SYMBOLS

-  Central Heating
-  Domestic Hot Water
-  Radio Frequency (RF) Transmitter

PROTECT YOUR ENVIRONMENT**PROPER BATTERY RECYCLING**

Electronic devices and batteries, rechargeable or not, should not be disposed of into ordinary household waste. Instead, they must be recycled properly to protect the environment and cut down the waste of precious resources. Your local waste management authority can supply details concerning the proper disposal of batteries.

ABBREVIATIONS

- CH = Central Heating
- DHW = Domestic Hot Water
- RF = Radio Frequency
- DLS = Daylight Saving
- BST = British Summer Time
- GMT = Greenwich Mean Time
- C = Celsius (Centigrade)
- IP = Ingress Protection
- V = Volt
- m = metre
- mA = milliAmpere

DEFINITIONS (DLS/BST)

Summer time begins: Last Sunday in March at 1:00 am GMT (Clocks are put forward by 1 hour)

Summer time ends: Last Sunday in October at 2:00 am BST (Clocks are put back by 1 hour)

TABLE OF CONTENTS

TECHNICAL DATA2
DIGISTAT ROOM THERMOSTAT3
 GENERAL INFORMATION3
 ADVANCED SETTINGS4
 FAULT DIAGNOSIS/ BATTERY REPLACEMENT9
DT20RF RECEIVER10
 GENERAL INFORMATION10
 OPERATING CONTROLS11
 PRE-PROGRAMMED SETTINGS12
 PROGRAMMABLE SETTINGS13
 INSTALLATION20
DIGISTAT INSTALLATION21
 SETTING UP THE RF LINK21
 MOUNTING THE DIGISTAT23
 TO CANCEL SIGNAL STRENGTH MODE24
 TO CHECK PREVIOUSLY INSTALLED UNIT25
MAINTENANCE28

TECHNICAL DATA

	DIGISTAT TRANSMITTER ROOM THERMOSTAT	DT20RF RECEIVER
Power supply	2xAA 1.5V alkaline batteries	24Vd.c. less than 65mA
Radio frequency	433 MHz	433 MHz
Radio signal range	The range may be affected by the composition / density and number of walls between the Digistat RF and receiver. 30 metres typically, through two internal plasterboard walls and a ceiling. 26 metres typically, through three internal plasterboard walls and a ceiling. 17 metres typically, through two internal plasterboard walls a ceiling and one external cavity wall. These distances are provided for guidance only, many factors can affect the range of the transmitter, including metal pipework, appliances and even furniture.	
Temperature setting range	5°C to 30°C	5°C to 30°C
Control Accuracy:	+ 0.5°C @ 20°C	better than ±1 second per day @ 25°C
Ambient Temperature: Operating	0°C to 50°C	0 to 50°C
Ambient Temperature: Storage	-20°C to 55°C	--
Humidity operating range	--	30 - 95 % non condensing up to 45°C
Mounting:	Suitable for surface mounting	
RF:	No wiring required	
DHW & CH ON/OFF periods	--	3 ON / 3 OFF
DHW & CH programs		7 days
Class of protection / Degree of protection	IP30	IP24
Battery back up time & date	- -	10 years minimum
Shortest switching period	- -	1 minute

EC Directives:
 European Union Law Directive 2000/84/EC
 Low Voltage Directive (2006/95/EC)
 Electro-Magnetic Compatibility Directive (89/336/EEC)
 EC Marking Directive (93/68/EEC)

STANDARD PACKAGE:
 Programmable / RF receiver
 Remote RF transmitter
 Screws (x2)
 Wall Plugs (x2)
 Instructions
 Batteries (x2) AA Alkaline

DIGISTAT ROOM THERMOSTAT GENERAL INFORMATION

What is a room thermostat?

A room thermostat simply switches the heating system on and off as necessary. It works by sensing the air temperature, switching on the heating when the air temperature falls below the thermostat setting, and switching it off once this set temperature has been reached.

Turning a room thermostat to a higher setting will not make the room heat up any faster. How quickly the room heats up depends on the design of the heating system, for example, the size of boiler and radiators.

Neither does the setting affect how quickly the room cools down. Turning a room thermostat to a lower setting will result in the room being controlled at a lower temperature, and saves energy.

The heating system will not work if a time switch or programmer has switched it off.

The way to set and use your room thermostat is to find the lowest temperature setting that you are comfortable with, and then leave it alone to do its job. The best way to do this is to set the room thermostat to a low temperature, at say 18°C and then turn it up by one degree each day until you are comfortable with the temperature. You won't have to adjust the thermostat further. Any adjustment above this setting may waste energy.

If your heating system is a boiler with radiators, there will usually be only one room thermostat to control the whole house. But you can have different temperatures in individual rooms by installing thermostatic radiator valves (TRVs) on individual radiators. If you don't have TRVs, you should choose a temperature that is reasonable for the whole house. If you do have TRVs, you can choose a slightly higher setting to make sure that even the coldest room is comfortable, then prevent any overheating in other rooms by adjusting the TRVs.

Room thermostats need a free flow of air to sense the temperature, so they must not be covered by curtains or blocked by furniture. Nearby fires, televisions, wall or table lamps may prevent the thermostat from working properly.

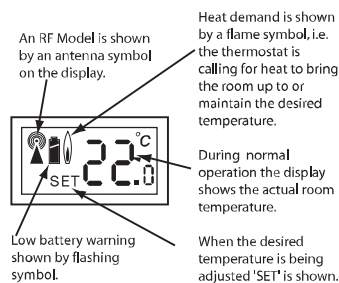
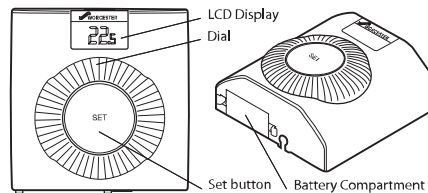

FEATURES

The Digistat RF room thermostat has the following user settings:

- Required room temperature (temperature set-point)
- Preset temperature setting - Advanced feature
- Minimum & Maximum temperature settings - Advanced feature

Simple Setting or Operating

To set the required room temperature

- The display normally shows the current room temperature to within 0.5°C
- To adjust the required temperature, turn the dial clockwise to increase or anti-clockwise to decrease, (1 click = 1°C), the LCD will display the temperature setpoint as it is being adjusted and 'SET' will be displayed. After a few seconds the display will return to normal operation and will display the actual room temperature.

While adjusting the temperature during normal operation, when you reach the maximum or minimum possible setting the display will flash to indicate you cannot adjust the product further.

DIGISTAT ROOM THERMOSTAT ADVANCED SETTING

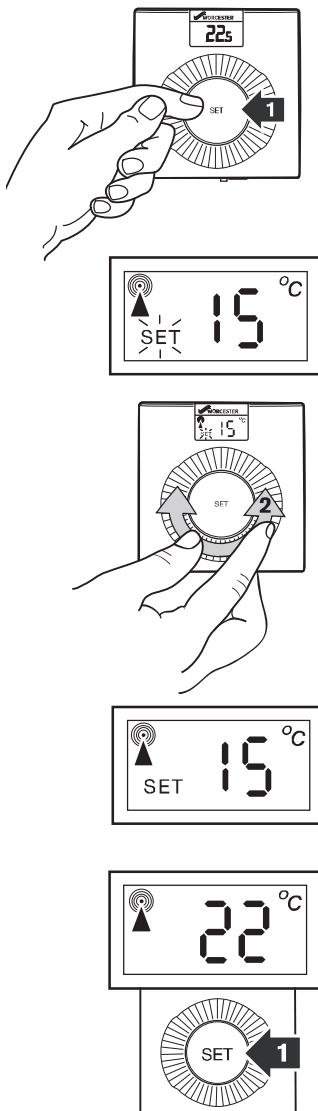

ADVANCED FEATURES

Adjusting the Setpoint using the Preset Temperature Mode

Change the temperature at the press of a button, for example, if you are going out to the shops for an hour you can reduce the temperature to save energy and then when you press the button again on your return the setpoint will return to the previous level.

- To adjust the setpoint to the preset (or Setback) temperature, press the **Set** button during normal operation and the product will go into Preset mode.

NOTE:

This feature can be used to quickly adjust the temperature setpoint to a setback temperature for economy operation if for example, "Preset Temperature = 15°C". Or alternatively to a comfort setpoint if "Preset Temperature = 21°C".

- Once the setpoint has been changed to the preset (or setback) temperature by pressing **Set** the display will show the "Preset Temperature" and **SET** will be flashing in the display as shown,

SET will flash for approximately 5 seconds and during this time the "Preset Temperature" can be altered by rotating the dial.

- The product will remain in the Preset mode. Once 5 seconds have elapsed (since the last dial adjustment) the word **SET** will stop flashing on the display as shown,

The product is still in the Preset mode.

To cancel the Preset Mode & return to normal operation

You can either,

- If you want to return to your previous setpoint (before you entered the Preset mode) then press the **SET** button. The Preset mode will be cancelled and the product will return to normal operation and the display will show the current room temperature as shown.

DIGISTAT ROOM THERMOSTAT
ADVANCED SETTING

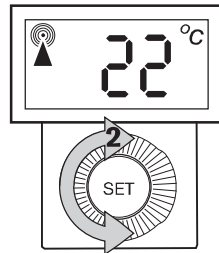

2. If you want to set a new setpoint, just rotate the dial until your required setpoint is shown on the display. After a couple of seconds the display will change to show the current room temperature as shown.

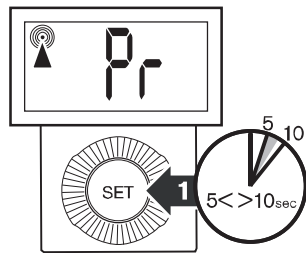

To change the user adjustable settings

1. To enter the **User** menu, press and hold the **Set** button for more than 5 but less than 10 seconds the display will show **Pr** (Preset temperature setting) as shown.

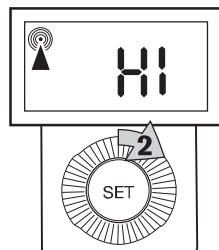

2. If the dial is turned clockwise one click then **HI** (Maximum temperature setting) will be displayed.

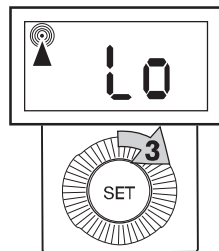

3. If turned one more click clockwise then **Lo** (Minimum temperature setting) will be displayed.

NOTE: When adjusting the settings within the menu, if the maximum or minimum possible setting are reached, the display will flash to indicate you cannot adjust the product further, e.g. you cannot set the Preset higher than the maximum temperature setting.

To return to normal operation, either **press the Set** button for **more than 5 seconds** or **wait for 1 minute** and it will return automatically.

DIGISTAT ROOM THERMOSTAT

ADVANCED SETTING

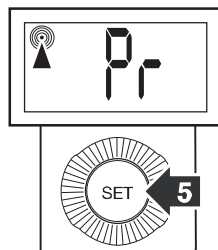
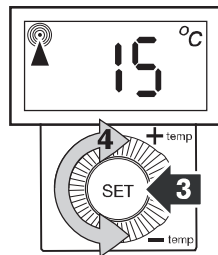
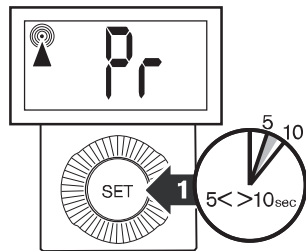

Changing the Preset Temperature

1. To adjust the "Preset" temperature enter the **User** menu by pressing and holding the **Set** button for more than 5 but less than 10 seconds.
2. Rotate the dial until **Pr** is shown.
3. Press the set button and the display will show the current Preset setting.
4. Rotate the dial clockwise to increase the Preset temperature & anti-clockwise to reduce the Preset temperature.
5. Press the **Set** button to confirm and **Pr** will be displayed.

NOTE: When adjusting the settings within the menu, if the maximum or minimum possible setting are reached, the display will flash to indicate you cannot adjust the product further, e.g. you cannot set the Preset higher than the maximum temperature setting.

To return to normal operation, either **press** the **Set** button for **more than 5 seconds** or **wait for 1 minute** and it will return automatically.

**DIGISTAT ROOM THERMOSTAT
ADVANCED SETTING**

Changing the Maximum Temperature Setting

1. To adjust the "Maximum" temperature enter the **User** menu by pressing and holding the **Set** button for more than 5 but less than 10 seconds.

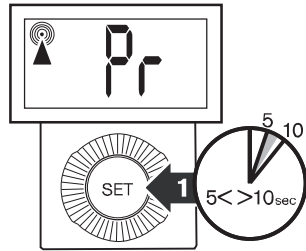

2. Rotate the dial clockwise until 'HI' is showing.

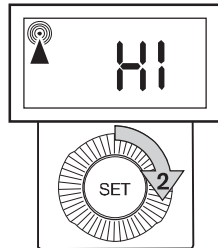

3. Then press the **Set** button, the current setting is shown.

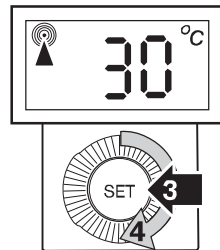

4. Rotate the dial clockwise to increase the maximum temperature setting (max. 30°C) as shown. Rotate anti-clockwise to reduce the maximum temperature setting.

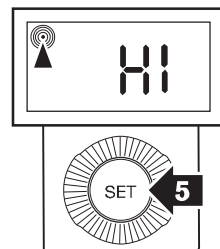

5. Press the **Set** button to confirm, the display will show HI.

NOTE: When adjusting the settings within the menu, if the maximum or minimum possible setting are reached, the display will flash to indicate you cannot adjust the product further, e.g. you cannot set the temperature higher than the maximum temperature setting.

To return to normal operation, either **press the Set button for more than 5 seconds** or **wait for 1 minute and it will return automatically.**

DIGISTAT ROOM THERMOSTAT
ADVANCED SETTING

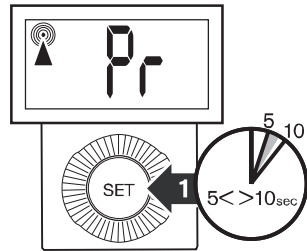

Changing the Minimum Temperature Setting

1. To adjust the "Preset" temperature enter the **User** menu by pressing and holding the **Set** button for more than 5 but less than 10 seconds.

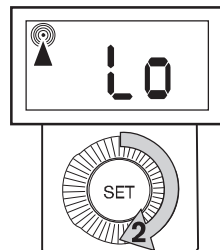

2. Rotate the dial clockwise until **Lo** is showing.

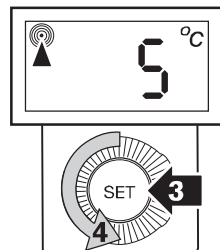

3. Then press the **Set** button, the current setting is shown.

4. Rotate the dial clockwise to increase the minimum temperature setting and anti-clockwise to reduce the minimum temperature setting (min. 5°C) as shown.

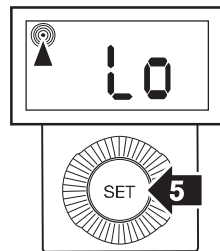

5. Press the **Set** button to confirm, the display will show **Lo**.

NOTE: When adjusting the settings within the menu, if the maximum or minimum possible setting are reached, the display will flash to indicate you cannot adjust the product further, e.g. you cannot set the temperature lower than the minimum temperature setting.

To return to normal operation, either **press** the **Set** button **for more than 5 seconds** or **wait for 1 minute** and it will return automatically.

DIGISTAT ROOM THERMOSTAT BATTERY REPLACEMENT

TAMPER PROOFING (All Models)

To tamper proof the product i.e. prevent unauthorised adjustment of the product, set the Min. and Max. (HI and Lo) temperatures to the same desired value using the procedures above.

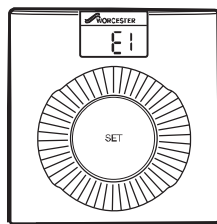

FAULT DIAGNOSIS (All Models)

If the display shows E1, the following faults could have occurred:

1. Internal temperature sensor has failed.
Replace the unit,
2. Ambient temperature is outside product operating temperature range - 0°C to 50°C.
When the ambient temperature is back within the operating range, the unit will function correctly.

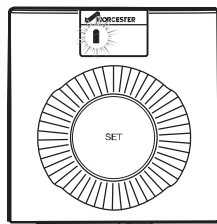

BATTERY REPLACEMENT (All Models)

- When the batteries are getting low (approx. 30 days battery life remaining) the battery symbol will flash in the display, it is recommended to change the batteries during this period.
- After approximately 30 days, a continuous battery symbol only will be shown in the display and the unit will remain OFF.

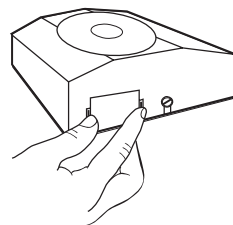
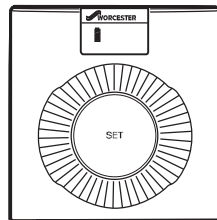

Remove the battery compartment by pinching the tabs and withdrawing down. Replace the spent batteries with 2 x AA 1.5V alkaline batteries ensuring correct orientation. Replace the battery compartment pressing fully home.

DT20RF RECEIVER
GENERAL INFORMATION

DT20RF Receiver Programmer

The Programmer has factory set programs for ON/OFF periods for central heating and hot water pre-heat, which are described on the following pages.
 These factory installed settings can be used without any further programming.

This section also details how to program the DT20RF Receiver for new weekday and weekend times to suit your lifestyle requirements.
 How to set the clock, time and date.
 A holiday function is provided, the number of days of your holiday can be set.
 After that set time period the boiler will revert to the normal program.

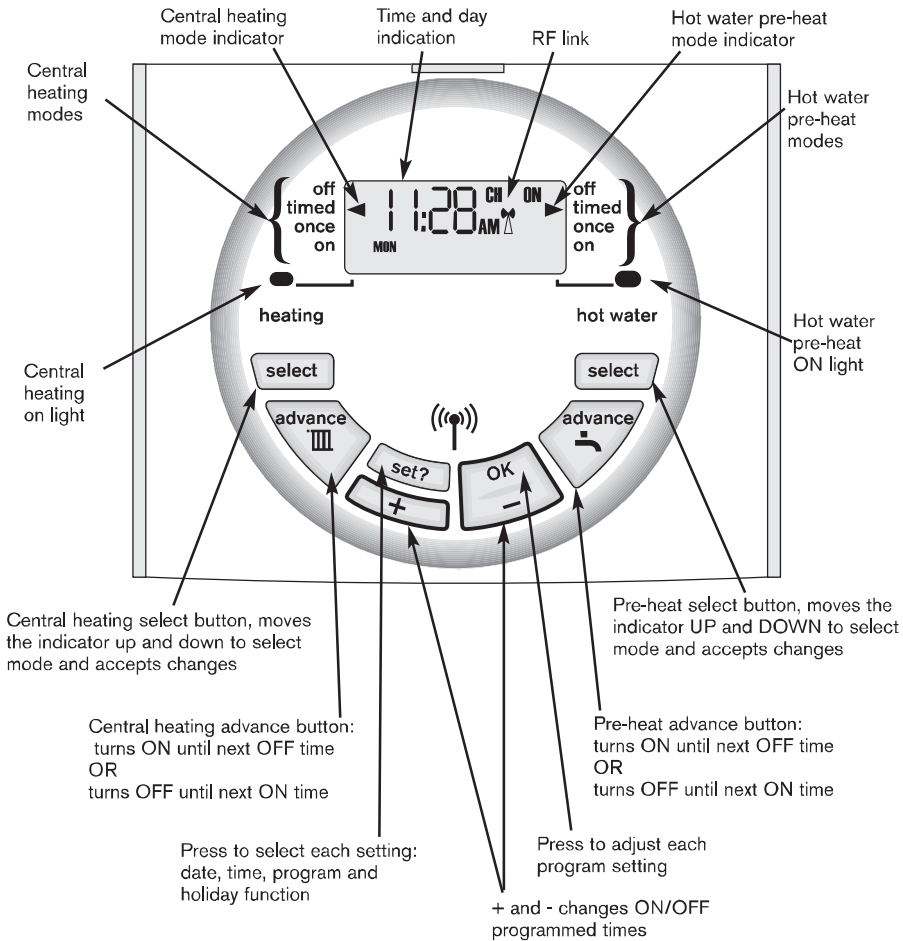

DT20RF RECEIVER
OPERATING CONTROLS

Central heating:

1. Press **select** button to choose

- ▶ **off** = constantly OFF
- ▶ **timed** = up to 3 ON & 3 OFF time periods as program
- ▶ **once** = ON from first ON until third OFF time period as program
- ▶ **on** = constantly ON

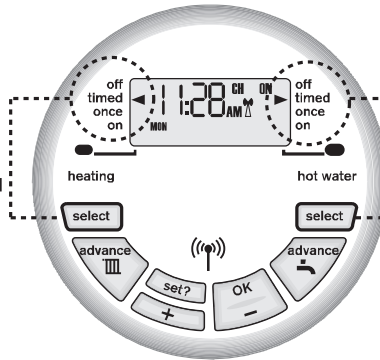

Hot Water:

3. Press **select** button to choose

- ▶ **off** = constantly OFF
- ▶ **timed** = up to 3 ON and 3 OFF time periods as program
- ▶ **once** = ON from first ON until third OFF time period as program
- ▶ **on** = constantly ON

2. Press "**advance**" button:

ON = heating light on (heating demand stays on until next off time period)

OFF = heating light off (heating demand stays off until next on time period)

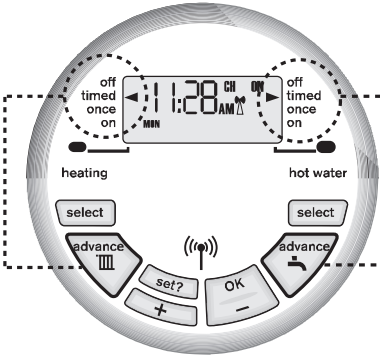

4. Press "**advance**" button:

ON = hot water pre-heat light on (hot water stays on until next off time period)

OFF = hot water pre-heat light off (hot water stays off until next on time period)

NOTE: Advance has no effect with constantly **on** or **off** is selected on the receiver or when there is no demand from the transmitter.

DT20RF RECEIVER
PRE-PROGRAMMED SETTINGS

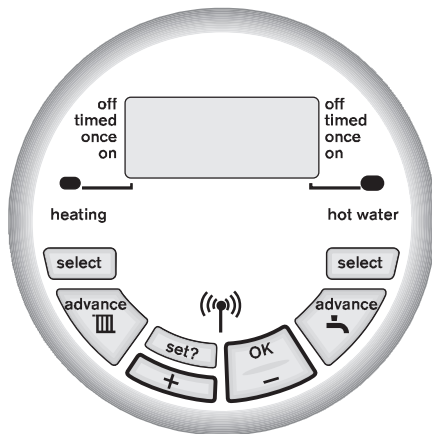

	1st ON	1st OFF	2nd ON	2nd OFF	3rd ON	3rd OFF
Central Heating:						
<i>MON to FRI</i>						
Time	6:30	8:30	12:00	12:00	16:30	22:30
<i>SAT & SUN</i>						
Time	7:00	9:00	12:00	12:00	16:00	23:00
Hot Water:						
<i>MON to FRI</i>						
Time	6:30	8:30	12:00	12:00	16:30	22:30
<i>SAT & SUN</i>						
Time	7:00	9:00	12:00	12:00	16:00	23:00

NOTE:

The ON/OFF periods pre-programmed for Central Heating and Hot Water pre-heat are shown in the table below.

These factory installed settings can be used without any further programming of the receiver.

The time and date are pre-programmed and should not require adjustment.

If you need to restore the factory pre-set program times then:

Press the + and - buttons together, for three seconds or longer, to restore the default program times to those shown in the table opposite.

NOTE:

Two ON/OFF periods can be used instead of three, by setting the second ON/OFF periods to 12:00 as shown in the default program table.

One ON/OFF period can be achieved by setting the second and third ON/OFF periods to the same times.

See DIGISTAT RECEIVER PROGRAMMABLE SETTING on the next page, if changes are required to the clock time or pre-programmed settings.

DT20RF RECEIVER
PROGRAMMABLE SETTINGS

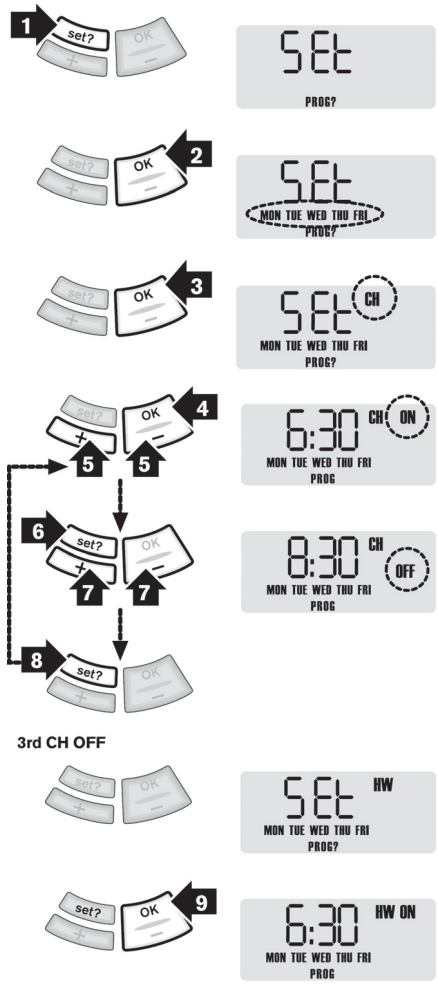

Setting Central Heating (CH) MON - FRI

1. Press **set?** until SET and PROG? are shown in the display.
2. Press **OK** to enter program.
3. Press **OK** to select MON-FRI.
4. Press **OK** to select CH.

NOTE: Speed up the display by holding down the + or - buttons.

5. Press + or - to change the ON time.
6. Press **set?** to set the ON time and select the OFF time.
7. Press + or - to change the OFF time.
8. Press **set?** to set the OFF time and select the next ON time.

Repeat operations 5 to 8 to set the second and third CH ON/OFF times.

NOTE: After pressing **set?** for the third CH OFF time the display shows SET MON ...see next page.

Setting Hot Water (HW) MON - FRI

9. Press **OK** to select the first ON time.

Repeat operations 5 to 8 to set the first, second and third HW ON/OFF times.

NOTE: After pressing **set?** for the third HW OFF time the display shows SET MON ...see next page.

DT20RF RECEIVER
PROGRAMMABLE SETTINGS

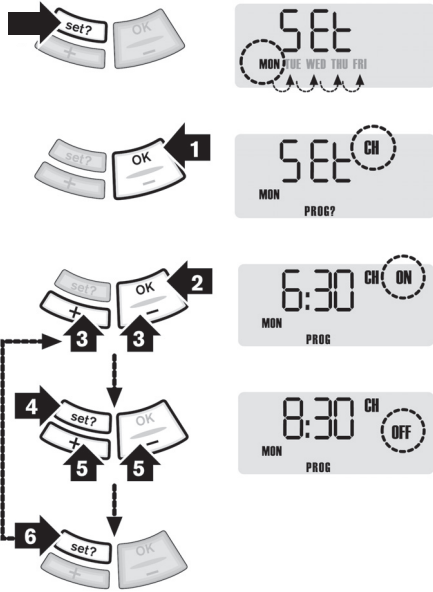

3rd CH OFF



Setting individual weekdays:

NOTE: If you do not require individual weekday times, then press **set?** until SET SAT-SUN are displayed and continue on the next page.

If you do not wish to change the setting for the day displayed, then press **set?** until the first day you want to change is displayed.

Setting Central Heating (CH) individual weekdays:

1. Press OK to select weekday.
2. Press OK to select CH.
- NOTE:** Speed up the display by holding down the + or - buttons.
3. Press + or - to change the ON time.
4. Press **set?** to set the ON time and select the OFF time.
5. Press + or - to change the OFF time.
6. Press **set?** to set the OFF time and select the next ON time.

Repeat operations 3 to 6 to set the second and third ON/OFF times.

NOTE: After pressing **set?** for the third CH OFF time, SET and HW for that weekday are displayed.

Setting Hot Water (HW) individual weekdays:

7. Press OK to select the first ON time.
- Repeat operations 3 to 6 to set the first, second and third HW ON/OFF times.

NOTE: After pressing **set?** for the third HW OFF time, SET and the next weekday are displayed....after completing the steps above for FRI the display shows SET SAT-SUN. see next page....

DT20RF RECEIVER
PROGRAMMABLE SETTINGS

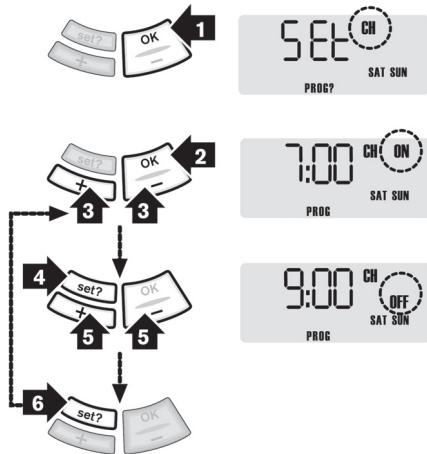

Setting Central Heating (CH) SAT - SUN:

1. Press OK to select weekend.
 2. Press OK to select CH.
- NOTE:** Speed up the display by holding down the + or - buttons.
3. Press + or - to change the ON time.
 4. Press **set?** to set the ON time and select the OFF time.
 5. Press + or - to change the OFF time.
 6. Press **set?** to set the OFF time and select the next ON time.
- Repeat operations 3 to 6 to set the second and third ON/OFF times.

NOTE: After pressing **set?** for the third CH OFF time, SET and HW for the weekend are displayed.



Setting Hot Water (HW) SAT - SUN:

7. Press OK to select the first ON time.
- Repeat operations 3 to 6 to set the first, second and third HW ON/OFF times.
- NOTE:** After pressing **set?** for the third HW OFF time, SET and SAT are displayed....see next page.

NOTE: If you do not require individual weekend day times, then press **set?** until the normal display is shown.

DT20RF RECEIVER
PROGRAMMABLE SETTINGS

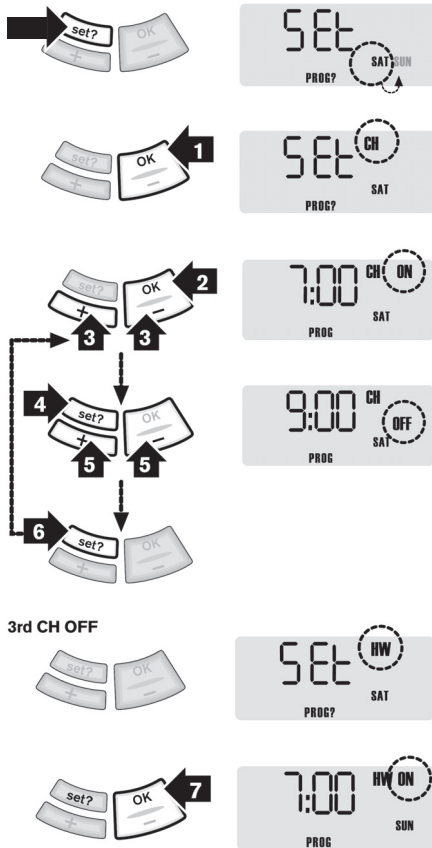

Setting individual weekend days:

NOTE: If you do not require individual weekend day times, then press **set?** until the normal display is shown.

If you do not wish to change the settings for SAT, then press **set?** to move to SUN.

Setting Central Heating (CH) individual weekend days:

1. Press OK to select the day displayed.
2. Press OK to select CH.

NOTE: Speed up the display by holding down the + or - buttons.

3. Press + or - to change the ON time.
4. Press **set?** to set the ON time and select the OFF time.
5. Press + or - to change the OFF time.
6. Press **set?** to set the OFF time and select the next ON time.

Repeat operations 3 to 6 to set the second and third ON/OFF times.

NOTE: After pressing **set?** for the third CH OFF time, SET and HW for that day are displayed.

Setting Hot Water (HW) individual weekend days:

7. Press OK to select the first ON time.

Repeat operations 3 to 6 to set the first, second and third HW ON/OFF times.

Pressing **set?** until the normal display is shown.

DT20RF RECEIVER PROGRAMMABLE SETTINGS

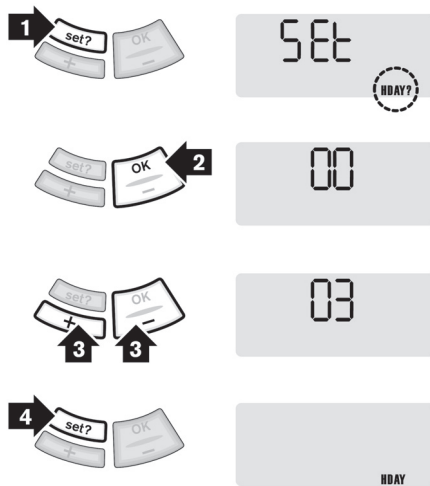

Setting holidays:

1. Press the **set?** button until SET and HDAY are displayed.
2. Press OK and the display shows 00.
3. Press + or - to set the number of days you require the system to be off.
4. Press **set?** then HDAY is shown in the display and no demand for heating will be made from the programmer.

The program will return to normal after the set number of days.

To cancel the holiday setting and return to normal operation, press any button.

NOTE: The programmer counts each pass through midnight as a day.
e.g. if you do not want heating from Saturday morning until Tuesday morning, set for three days.

DT20RF RECEIVER
PROGRAMMABLE SETTINGS

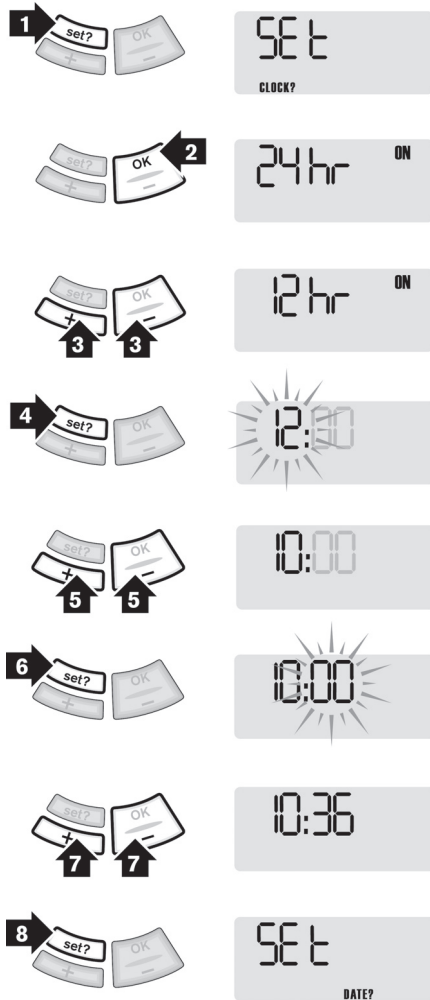

Setting the clock and time

1. Press the **set?** button until SET and CLOCK are shown in the display.
2. Press OK to display 24hr and ON.
3. Press + to switch between 24hr and 12hr display.
4. Decide between 24 hour or 12 hour display and press set? to select, now the hours will flash.
5. Press + or - to set the correct hour.

NOTE: Speed up the display by holding down the + or = buttons.

6. When the correct hour has been selected, press set? to select, now the minutes will flash.
7. Press + or - to set the correct minutes.
8. When the correct minutes have been set, press **set?** to select that setting.

Now SET and DATE will be displayed.

If the day and date needs resetting, refer to the next page for SETTING THE DATE.

If the day and date are correct, press **set?** to return to the normal display.

DT20RF RECEIVER

PROGRAMMABLE SETTINGS

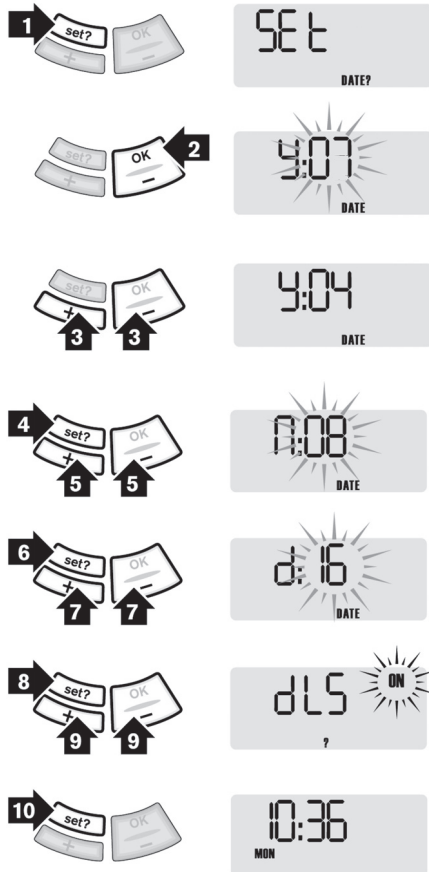

Setting the date:

1. Press the **set?** button until SET and DATE? are displayed.
2. Press the OK button once, the year flashes on the display.
3. Press + or - to set the correct year, e.g. 07.
4. When the correct year has been chosen, press **set?** to select, now the month will flash.
5. Press + or - to select the correct month, e.g. 08.
6. When the correct month has been chosen, press **set?** to select, now the day will flash.
7. Press + or - to select the correct day, e.g. 16.
8. When the correct day has been chosen, press **set?** to select, now dLS will be displayed and ON will flash.
9. Press + or - to switch between ON or OFF. If you choose ON then the clock will automatically adjust the time for Daylight saving. If you choose OFF then the time will not change to take account of the Daylight Saving time change twice a year.
10. Press **set?** twice to return to the normal display.

NOTE: dLS = Day Light Savings time

**DT20RF RECEIVER
INSTALLATION**

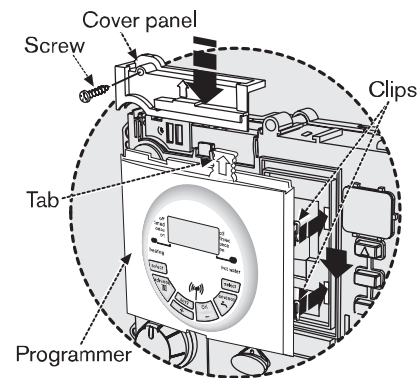
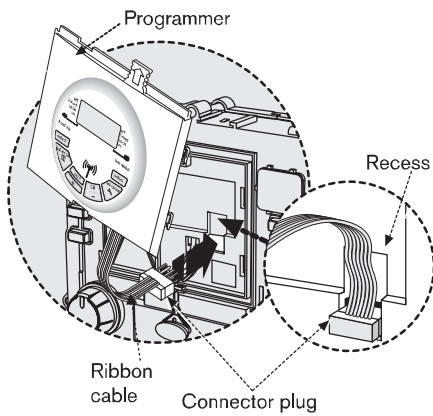
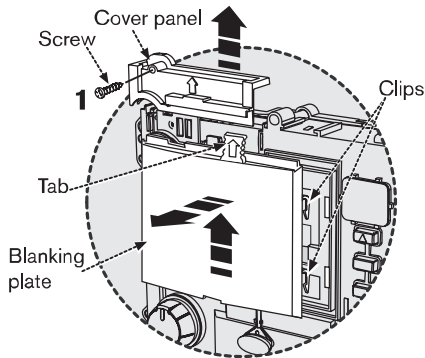

**DANGER: 230 VOLTS
DO NOT TOUCH THE ELECTRICAL
COMPONENTS OR CIRCUITS**

**CAUTION:
ISOLATE THE MAINS ELECTRICITY
SUPPLY BEFORE STARTING ANY WORK
OBSERVE ALL RELEVANT SAFETY
PRECAUTIONS**

**OBSERVE ELECTRO-STATIC
DISCHARGE PRECAUTIONS:
DO NOT TOUCH THE PCB CIRCUIT**

NOTE: THIS ACCESSORY MUST BE FITTED BY A COMPETENT PERSON. FAILURE TO COMPLY COULD LEAD TO PROSECUTION.

1. Remove the boiler outer casing and control panel fascia to gain access to the heatronic control panel.
 2. Release the securing screws.
 3. Pull the cover panel up to remove.
 4. Grip the tab and pull upwards to disengage clips, pull forward to remove blanking plate or existing programmer.
 5. Align the connector plug pins into socket on the PCB and push fully home.
 6. Feed the ribbon cable into the recess.
 7. Align the programmer and locate the clips, push into the slots then down to secure.
 8. Locate the cover panel in place and secure with the screw.
 9. Replace fascia cover and outer casing before switching on the electrical supply and boiler.
Switch boiler on when completed.
- Refer to the User Instructions section for details of pre-set and setting programs.

**DIGISTAT
INSTALLATION**

**DIGISTAT / DT20RF RECEIVER
SETTING UP THE RF LINK**

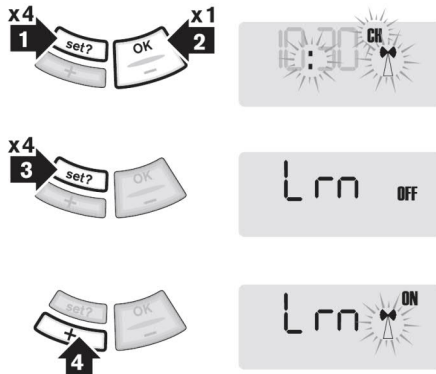

Receiver set up:

After initial start up, the colon, CH and antenna symbols should be flashing on the display.

1. Press the set? button 4 times
2. Press the OK button once
3. Press the set? button 4 times; Lrn and OFF should be displayed
4. Press the + button so the display shows ON and a flashing antenna symbol. The learn mode is now ready to receive a signal from the transmitter during the next two minutes.

Transmitter battery compartment

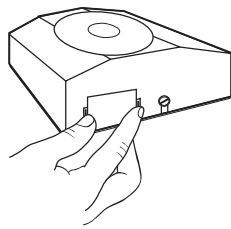

Transmitter set up:

1. Take the Digistat Programmer unit and stand near the boiler.
2. Remove the battery cover and fit the batteries.

How to fit the batteries

Remove the battery compartment by pinching the tabs and withdrawing down. Replace the spent batteries with 2 x AA 1.5V alkaline batteries ensuring correct orientation. Replace the battery compartment pressing fully home.

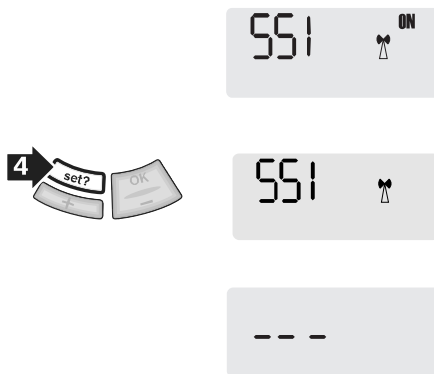

3. The symbols on the receiver will stop flashing and the display will show 'SSI, Antenna and ON'.
4. Press 'SET' on the receiver and the display will show 'SSI and Antenna'.
5. After a few seconds the display will show '- - -'.

DIGISTAT / DT20RF RECEIVER
SETTING UP THE RF LINK

DIGISTAT
INSTALLATION

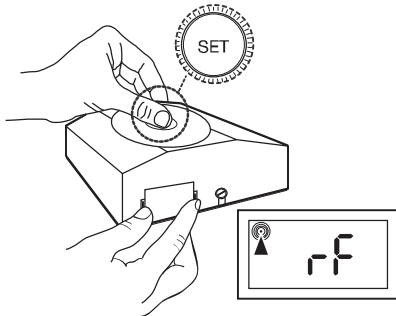

6. Remove the batteries from the Digistat and wait for the display to fade.
7. Press and hold the 'SET' button while re-inserting the batteries and keep the button depressed until the display shows 'rF'.

The Digistat is now in constant transmission mode enabling it to be correctly positioned within the home.

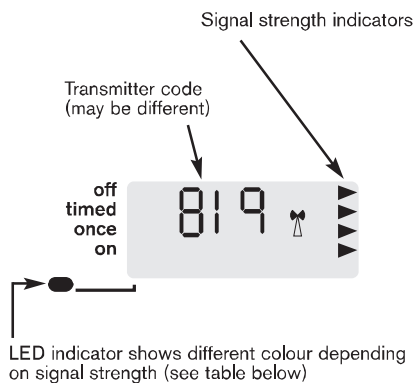

8. The receiver display will now show the 'learnt' transmitter code and the antenna' as well as the signal strength as indicated by the chevrons on the left hand side of the display.
9. Place the transmitter in the desired final position and return to the boiler to check the receiver display. The ideal transmitter position will result in the receiver display showing 4 chevrons and the LED will be green.
9. If the LED is red or no LED is showing and the display indicates 1 or 2 chevrons, the transmitter will need to be re-positioned until the LED changes to amber or green and 3 or 4 chevrons are indicated on the display.

NOTE: If there is no LED and the display shows '- - -', there is no signal being received at all from the transmitter. Transmission will resume once the transmitter is re-positioned in a part of the house where an amber or green LED and 3 or 4 chevrons are achieved.

10. Once you are happy that, when in the desired location, the transmitter is sending a good signal to the receiver i.e. amber or green and 3 or 4 chevrons, the transmitter can be fixed to the wall.

LED Indication	Chevrons	RF Strength
Green	4	Very strong
Amber	3	Strong
Red	2	Weak
None	1	Very weak

DIGISTAT INSTALLATION

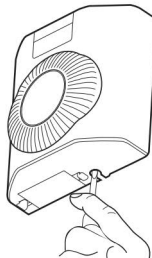
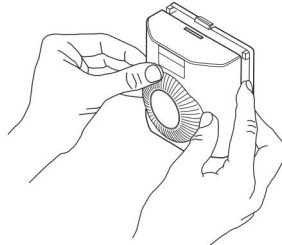
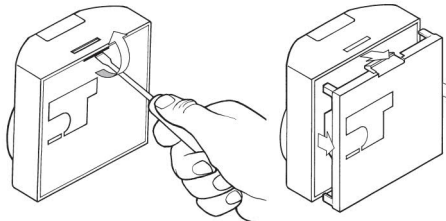
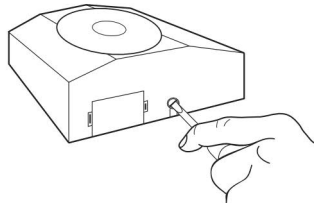
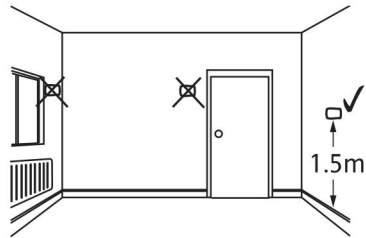

DIGISTAT / DT20RF RECEIVER MOUNTING THE DIGISTAT

Positioning the Digistat RF room thermostat

The Digistat is a radio frequency device which is very flexible for positioning as there is no need for hard wiring to the appliance. The device should be mounted in a open area, no closer than 30cm from metal objects, including wall boxes.

Mount the Digistat on a wall which is not subject to direct sunlight or draughts, preferably on an inside wall, 1.5 metres above the floor. The Digistat must also not be directly influenced by radiators or other appliances giving off heat.

Mounting the Digistat RF room thermostat

1. Loosen the single screw from the bottom of the transmitter using a small flat bladed screwdriver.
2. Carefully insert the screwdriver into the slot located at the back of the digistat near the top and very gently lever upwards a fraction to release the tab securing the front of the transmitter to the back cover.
The back cover can now be secured to the wall.
3. Replace the front by locating in position and pushing fully onto the back cover until the tab engages at the top of the transmitter.
4. Retighten the screw at the bottom of the unit to fully secure the front to the back cover.

DIGISTAT / DT20RF RECEIVER
TO CANCEL SIGNAL
STRENGTH MODE

DIGISTAT
INSTALLATION

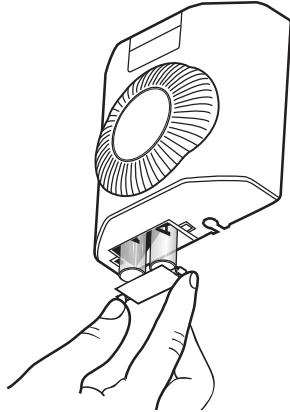

To cancel signal strength mode:

1. Remove the batteries from the transmitter to cancel the constant transmission.

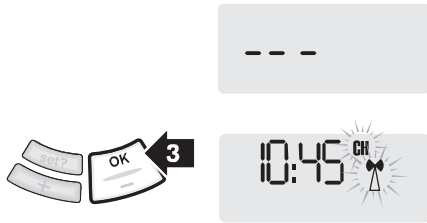

2. After a few seconds the receiver display will show '---'.

3. Press 'OK' on the receiver display and the display will return to the time with the 'CH and Antenna' flashing.

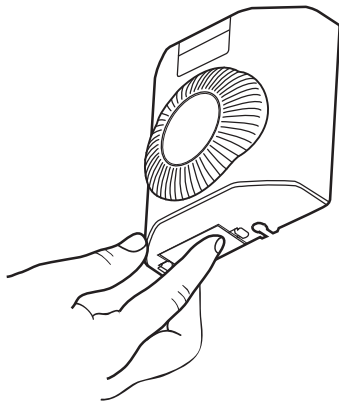

4. Re-insert the batteries into the transmitter and the RF link will be re-established.

**DIGISTAT
INSTALLATION**

**DIGISTAT / DT20RF RECEIVER
TO CHECK PREVIOUSLY
INSTALLED UNIT**

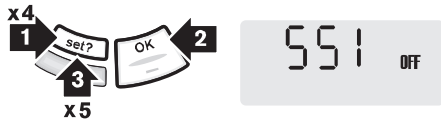

To check signal strength on previously installed and paired units :

1. Press the 'set' button 4 times.
2. Press 'OK' once.
3. Press the 'set' button 5 times. The display will show 'SSI and OFF'.



4. Press the '+' button so that the display shows 'SSI, Antenna and ON'.



5. Press the 'set' button so the display shows 'SSI and Antenna'.



6. After a few seconds the display will show '---'.

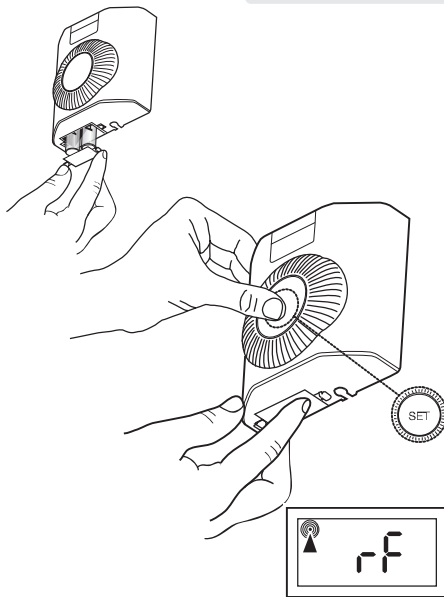

7. Remove the batteries from the transmitter and wait until the display has faded away.

8. Press and hold the SET button on the transmitter while re-inserting the batteries and keep the button depressed until the display shows 'rf' .

DIGISTAT / DT20RF RECEIVER

TO CHECK PREVIOUSLY
INSTALLED UNIT

**DIGISTAT
INSTALLATION**

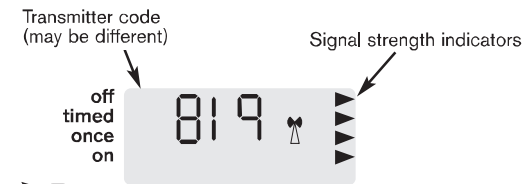

LED indicator shows different colour depending on signal strength (see table below)

LED Indication	Chevrons	RF Strength
Green	4	Very strong
Amber	3	Strong
Red	2	Weak
None	1	Very weak

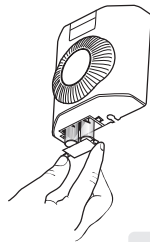

To cancel signal strength mode:

1. Remove the batteries from the transmitter to cancel the constant transmission.

2. After a few seconds the receiver display will show '---'.

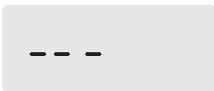

3. Press 'OK' on the receiver display and the display will return to the time with the 'CH and Antenna' flashing.



4. Re-insert the batteries into the transmitter and the RF link will be re-established.

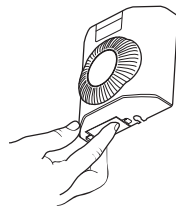

DIGISTAT
INSTALLATION

DIGISTAT / DT20RF RECEIVER
NORMAL OPERATION

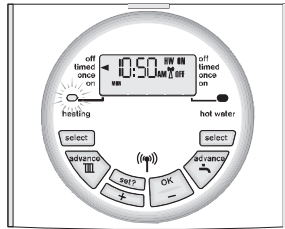

During normal operation

The LED on the receiver will flash red, approximately every 5 minutes. This denotes that a radio signal is being received from the transmitter.

**DIGISTAT/DT20RF RECEIVER
MAINTENANCE**

**Digistat RF Room thermostat
part number 8 716 114 463 0**

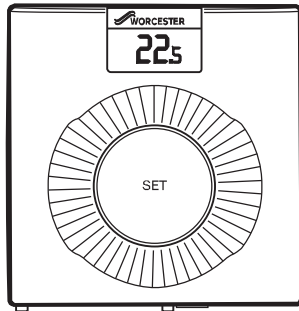

Maintenance:

The Digistat RF Room thermostat requires no maintenance.
The outer casing can be wiped clean using a dry cloth. DO NOT use polish or detergents.

These units can not be serviced.

Should the existing units fail to function correctly, check that the:

- ▶ DT20RF Receiver times and program settings are correct.
 - ▶ RF signal link is set up (Refer to page 2 for RF signal range details).
 - ▶ Digistat RF Room thermostat batteries are the correct type, fitted correctly and are not exhausted.
- Fit new batteries if in doubt.

**DT20RF Receiver
part number 8 716 106 669 0**

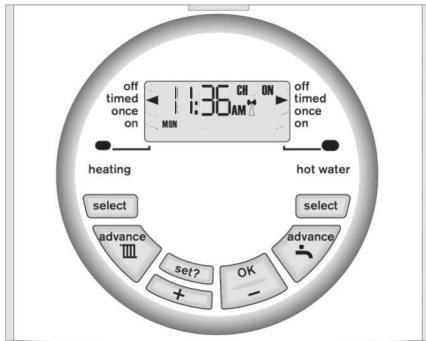

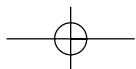
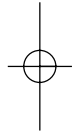

CONTACT INFORMATION

WORCESTER, BOSCH GROUP:

TECHNICAL: 08705 266241
SERVICE: 08457 256206
SPARES: 01905 752571
LITERATURE: 01905 752556
TRAINING: 01905 752526
SALES: 01905 752640
WEBSITE: worcester-bosch.co.uk
WEBSITE (EIRE): worcester-bosch.ie

Worcester, Bosch Group
Cotswold Way, Warndon, Worcester WR4 9SW.
Tel. 01905 754624 Fax. 01905 754619

worcester-bosch.co.uk

Worcester, Bosch Group is a brand name of Bosch Thermotechnology Ltd.

8 716 115 495a (02.2009) 06515058001 ISSB

