



Installation and operating instructions

Temperature difference controller

4 inputs, 2 outputs

These operating instructions are part of the product.

- ▶ Read these operating instructions carefully before use,
- ▶ keep them over the entire lifetime of the product,
- ▶ and pass them on to any future owner or user of this product.

Index

1	Safety	4
1.1	Proper usage.....	4
1.2	Dangers during assembly/commissioning.....	4
1.3	Detecting faults	5
1.4	Hot water temperature.....	5
1.5	Disposal	5
1.6	Exclusion of liability	5
2	Case overview	6
3	About this manual	7
3.1	Applicability	7
3.2	Users	7
3.3	Description of symbols	7
4	Installation	8
4.1	Opening/closing the housing.....	8
4.2	Assembly.....	9
4.3	Electrical connection.....	10
4.4	Dismantling.....	11
4.5	Terminal plan	12
5	Commissioning	15
5.1	Setting the language	15
5.2	Setting the system group	15
5.3	Setting the system	15
6	Modes of operation	16
6.1	"OFF" mode	16
6.2	"Automatic" mode.....	16
6.3	"Manual" mode	16
7	Settings	17
7.1	Systems.....	17
7.2	Functions	24
7.3	Parameters	35
7.4	Storage priority.....	37
7.5	Language	38
7.6	Factory settings.....	38
8	Automatic operation	39
8.1	Status display.....	40
8.2	Temperature sensor min/max display.....	40
8.3	Operating hours display for pumps switching valves	40

9	Fault finding	41
9.1	Causes of problems	42
9.2	Pt1000 temperature sensor values.....	43
10	Information windows	44
11	Plausibility indices	46
12	Legal guarantee	47
13	Technical data	48
13.1	Performance data	48
13.2	Parameter settings	49
13.3	Parameter values for functions	52
14	Notes	55

Product information

EC declaration of conformity

"This product conforms to the applicable European directives with regard to its design and its operating behaviour. This conformity has been verified. Further information in this regard can be obtained from your dealer."

1 Safety

1.1 Proper usage

The temperature difference controller (hereinafter referred to as controller) is an independently installed electronic temperature controller for on-surface installation, and may only be used for controlling solar thermal systems within the permissible ambient conditions (see chapter 13 "Technical data").

The controller must not be operated in the following environments:

- outdoors
- in damp rooms
- in rooms where highly flammable gas mixtures can occur
- in rooms in which the operation of electrical and electronic components may cause dangers to arise

1.2 Dangers during assembly/commissioning

The following dangers exist during installation/commissioning of the controller and during operation (in case of installation errors):

- Risk of death by electrocution
- Risk of fire due to short-circuit
- Damage to any of the constructional fire safety measures present in the building due to incorrectly installed cables
- Damage to the controller and the connected devices due to improper ambient conditions, inappropriate power supply and the connection of prohibited devices, faulty devices, or devices not included in the device specifications, as well as incorrect assembly or installation.

NOTE

Observe the controller's type plate!

Therefore, all safety regulations apply when working on the mains supply. Only electricians may perform work that requires opening the controller (such as electrical connection work).

- ▶ When laying cables, ensure that no damage occurs to any of the constructional fire safety measures present in the building.
- ▶ Make sure that the permissible ambient conditions at the installation site are not exceeded (see chapter 13 "Technical data").
- ▶ Be sure to comply with the specified ingress protection.
- ▶ Labels and markings applied in the factory may not be altered, removed or rendered unreadable.
- ▶ Before connecting the device, make sure that the power supply matches the specifications on the type plate.
- ▶ Make sure that all devices which are connected to the controller conform to the technical data of the controller.
- ▶ Secure the device against unintentional start-up.
- ▶ All work on an open controller must be performed with the mains supply disconnected.
- ▶ Protect the controller against overloading and short-circuiting.

1.3 Detecting faults

- ▶ Check the display regularly.
- ▶ In case of faults, isolate the cause (see chapter 9.1 "Causes of problems").
- ▶ As soon as it becomes evident that safe operation is no longer guaranteed (e.g. visible damage), remove the device from the mains supply immediately.
- ▶ Have trained professional personnel remedy the fault.

1.4 Hot water temperature

In order to limit the hot water temperature to 60 °C at the outlets, a hot water mixer must be installed.

1.5 Disposal

- ▶ Dispose of the controller in accordance with the regional regulations.

1.6 Exclusion of liability

The manufacturer can neither monitor the compliance with this manual nor the conditions and methods during the installation, operation, usage and maintenance of the controller. Improper installation of the system may result in damage to property and, as a result, to bodily injury.

Therefore, the manufacturer assumes no responsibility and liability for loss, damage or costs which result from or are in any way related to incorrect installation, improper operation, incorrect execution of installation work and incorrect usage and maintenance.

Similarly, we assume no responsibility for patent right or other right infringements of third parties caused by usage of this controller.

The manufacturer reserves the right to make changes to the product, technical data or installation and operating instructions without prior notice.

2 Case overview

Operating switch

The following modes of operation can be selected:

- **Manual**
for commissioning and testing for function
- **Automatic**
for automatic operation
- **Off**
for switching off the outputs



Display

Display for controller operation and system settings

Operating buttons

Arrow up
for scrolling up through the menus

SET button
Confirmation or Activation of a value

ESC button
escape key

Arrow down
for scrolling down through the menus

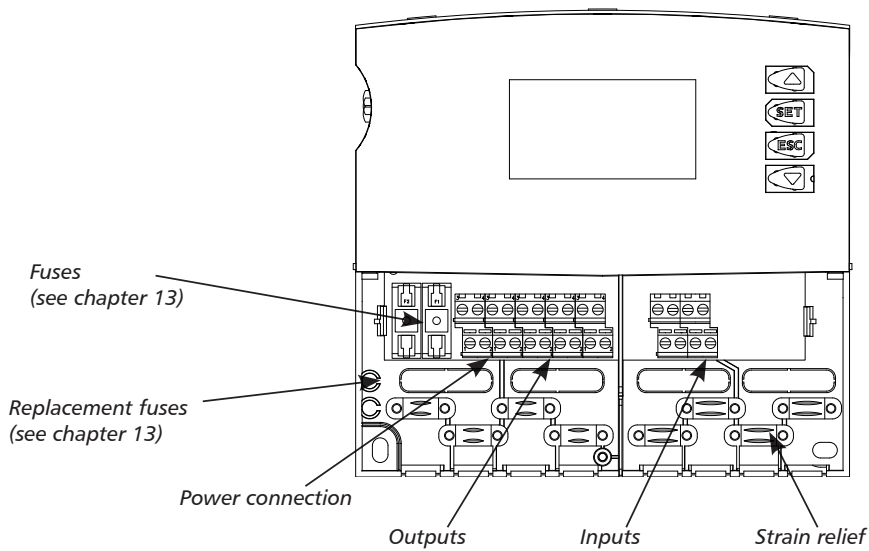
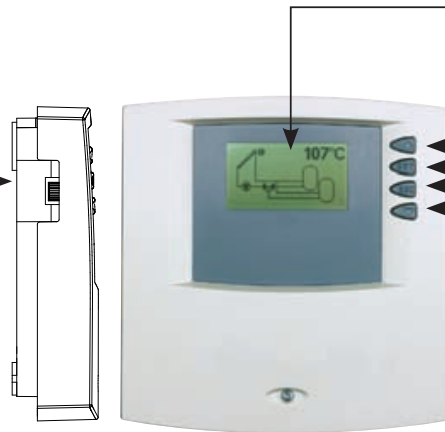

3 About this manual

3.1 Applicability

This manual describes the installation, commissioning, operation, maintenance and dismantling of the temperature difference controller for solar thermal energy systems. When installing the remaining components, e.g. solar collectors, pump assemblies, storage units, pumps and switching valves, be sure to observe the appropriate installation instructions provided by each manufacturer.

3.2 Users

Installation, commissioning, maintenance and dismantling of the controller may only be performed by trained professional personnel. Before commissioning, the controller must be professionally assembled and installed by professional personnel in accordance with the applicable regional and transregional regulations as well as the safety instructions and general instructions within these installation and operating instructions. The professional personnel must be familiar with these operating instructions.

The controller is maintenance-free.

Use the controller only after first thoroughly reading and understanding these operating instructions and the safety instructions. Adhere to all safety instructions and consult professional personnel in the event of any ambiguities.

This device is not intended for persons (or children) with physical, sensory, or mental disabilities, or who have inadequate experience and knowledge, unless they are instructed in the use of the device, and initially supervised, by a person responsible for their safety. Children should not be left alone with the device, to ensure that they do not play with it.

3.3 Description of symbols



3.3.1 The structure of the warning notices

SIGNAL WORD

Type, source and consequences of the danger!

- ▶ Measures for avoiding danger.

3.3.2 Danger levels in warning notices

Danger level	Likelihood of occurrence	Consequences resulting from non-compliance
 DANGER	Imminent threat of danger	Death, serious bodily injury
 WARNING	Possible threat of danger	Death, serious bodily injury
 CAUTION	Possible threat of danger	Minor bodily injury
CAUTION	Possible threat of danger	Property damage

3.3.3 Notes

NOTE

Note on easier and safer working habits.

- ▶ Measures for easier and safer working habits.

3.3.4 Other symbols and markings

Symbol	Meaning
✓	Precondition for action
▶	Call to action
⇒	Result of action
•	List
Emphasis on issue at hand	Emphasis on issue at hand
△▽:	Press "Arrow up/down" for scrolling
▽:	Press "Arrow down" for scrolling through the menu or to adjust a value
△:	Press "Arrow up" for scrolling through the menu or to adjust a value
SET:	Press "SET" button to confirm or activate a value
ESC:	Press "ESC" button to cancel

4 Installation

4.1 Opening/closing the housing

DANGER

Risk of death by electrocution!

- ▶ Remove the controller from the power supply before opening the case.
- ▶ Make sure that the power supply cannot be unintentionally switched back on.
- ▶ Do not damage the casing.
- ▶ Only switch the power supply back on after the casing has been closed.

The upper casing is connected to the lower casing by two latches, and fastened with a screw.

4.1.1 Opening the case

- ▶ Loosen the screw and remove the upper case in an upwards direction.

4.1.2 Closing the case

- ▶ Place the upper case over the lower case at an angle. Insert the latches into the recesses of the lower case.
- ▶ Pivot the upper case down and feed the operating buttons through the matching holes.
- ▶ Fasten the casing tightly with the screw.

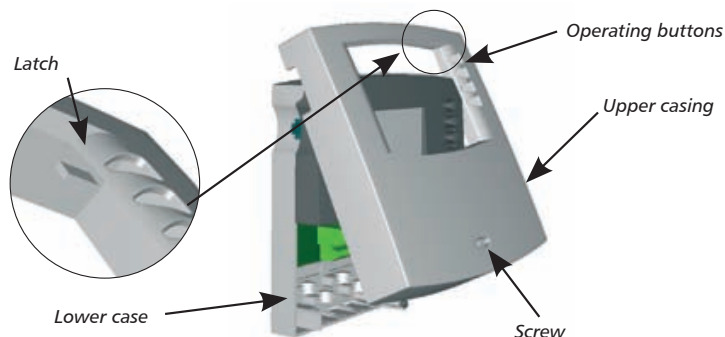

4.2 Assembly



WARNING

Risk of electrical shock and fire if mounted in a damp environment!

- ▶ Only mount the controller in an area where the ingress protection is sufficient (see chapter 13 "Technical data").

4.2.1 Mounting the controller



CAUTION

Risk of injury and damage to the casing when drilling!

- ▶ Do not use the casing as a drilling template.
-
- ▶ Choose a suitable installation site.
 - ▶ Drill the upper fastening hole.
 - ▶ Screw in the screw.
 - ▶ Remove the upper casing.
 - ▶ Hang the case in the recess ①.
 - ▶ Mark the position of the lower fastening holes ②, ③.
 - ▶ Remove the casing again.
 - ▶ Drill the lower fastening holes.
 - ▶ Rehang the case in the recess ①.
 - ▶ Screw the case firmly using the lower fastening holes ② and ③.
 - ▶ Mount the upper casing.

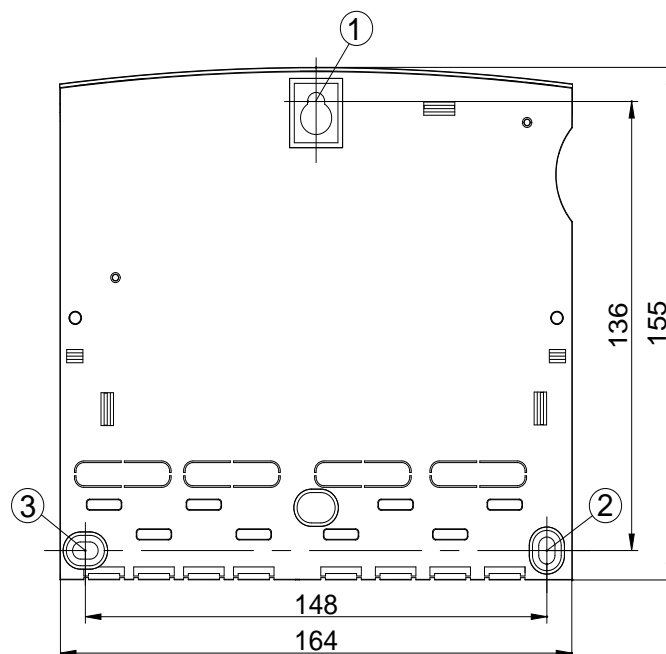

4.3 Electrical connection

DANGER

Risk of death by electrocution!

- ▶ Remove the controller from the power supply before opening the case.
- ▶ Observe all applicable legal guidelines and regulations of the local electricity supplier.

NOTE

The device is to be connected to the mains by means of a plug with grounding contact, or in the case of a fixed electrical installation, via a disconnection device for complete disconnection in accordance with the installation guidelines.

4.3.1 Preparing the cable feed

Depending on the type of installation, the cables may enter the device through the rear of the case ④ or the lower side of the case ⑤.

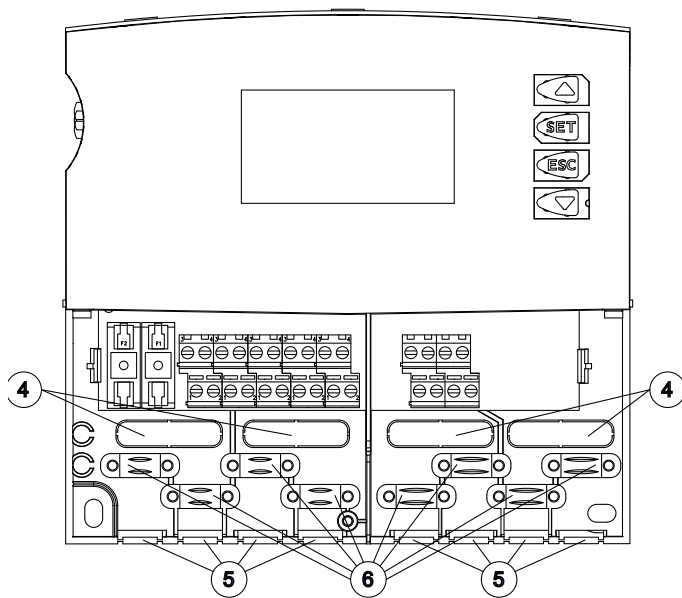

Feeding the cable through the rear of the case:

- ▶ Remove the plastic flaps ④ from the rear side of the case using an appropriate tool.

WARNING

Risk of electrical shock and fire due to cables coming loose!

- ▶ Install an external strain relief for the cables.

Feeding the cable through the lower side of the case:

- ▶ Cut the left and right plastic flaps ⑤ using an appropriate tool and break them out of the case.
- ▶ Fasten cable at position ⑥ with the provided plastic links.



4.3.2 Connecting the cables

- ▶ If a protective conductor is provided or required for pumps/valves, connect it to the corresponding terminals of the controller. When connecting the protective conductor, observe the following points:
 - Make sure that the protective conductor is also connected to the controller's mains supply side.
 - Each terminal may only be connected to a single connecting wire (max. 2.5 mm²).
- ▶ The terminal screws are approved for connection of cables as follows:
 - single wire (solid): ≤ 2.5 mm²
 - fine strand (with core end sleeves): ≤ 1.5 mm²
- ▶ Only use the original temperature sensors (Pt1000) that are approved for use with the controller.
- ▶ Observe the following points:
 - The polarity of the temperature sensor contacts is not important.
 - Do not lay sensor cables close to power cables (minimum separation: 100 mm).
 - If inductive effects are expected, e.g. from power cables, overhead wires, transformer substations, radio and television devices, amateur radio stations, microwave devices, etc., the sensor cables must be adequately screened.
 - Sensor cables may be extended to a maximum length of 100 m.
- ▶ If adding extensions to sensor cables, select the following cable cross sections:
 - 0.75 mm² up to 50 m long
 - 1.5 mm² up to 100 m long
- ▶ Connect the cables in accordance with the terminal diagram (see chapters 4.5 and 7.1).

4.4 Dismantling

DANGER

Risk of death by electrocution!

- ▶ Remove the controller from the power supply before dismantling it.
- ▶ To dismantle the controller, follow the assembly instructions in the reverse order.



4.5 Terminal plan

4.5.1 Power connection

- Please refer to the type plate on the case to determine the type of power supply required.
- The protective conductor must be connected.
- Cables conforming to at least type H05 VV-.... (NYM...) must be used.

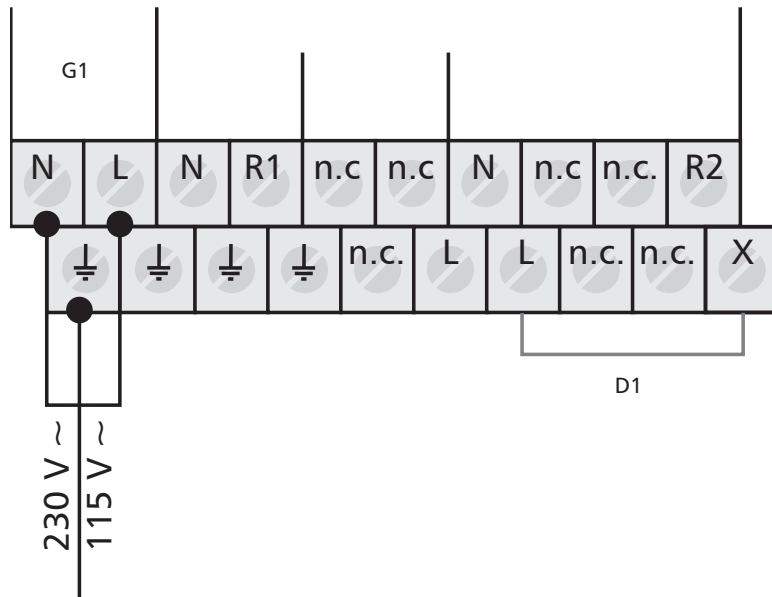

G1: grid
D1: wire bridge

4.5.2 Connection of the inputs

- Inputs 1 - 4: for Pt1000 temperature sensor

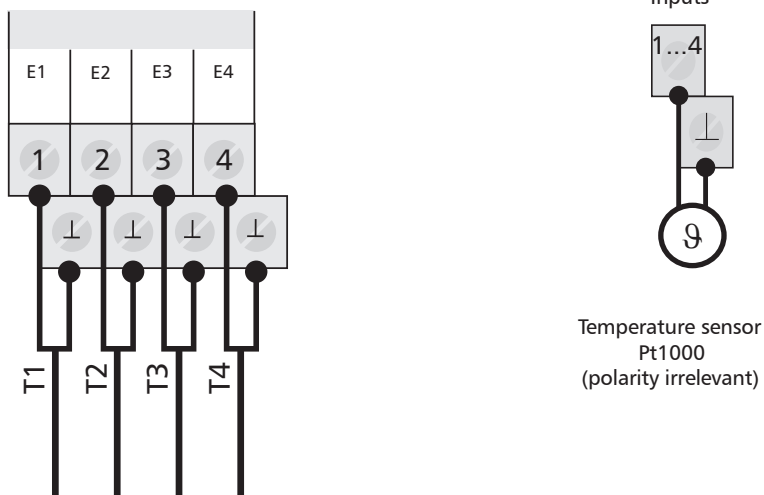

E1: input 1
E2: input 2
E3: input 3
E4: input 4

Temperature sensor
Pt1000
(polarity irrelevant)

4.5.3 Connection of outputs R1 and R2

Output R1:

- Semiconductor relays (TRIAC), also suitable for RPM control; max. switching current: see type plate

CAUTION

Avoiding damage and malfunctions

- ▶ When connecting an external relay or contactor, or when connecting a pump which has its own electronic RPM control, the controller output's RPM control must be deactivated (see chapter 7.3.3 "Setting the RPM control parameters").

R1: output 1
R2: output 2
D1: wire bridge

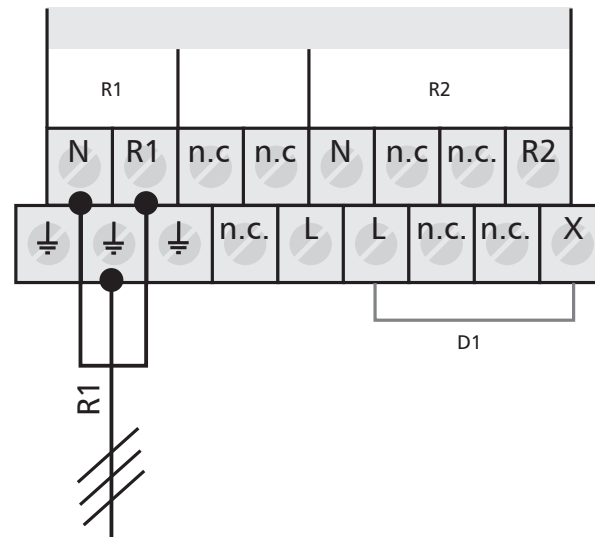

Output R2: switched output or potential-free output

- 230 VAC switched output (option: 115 VAC) via electromechanical relay; max. switching current: see type plate; wire bridge must be connected!

R1: output 1
R2: output 2
D1: wire bridge

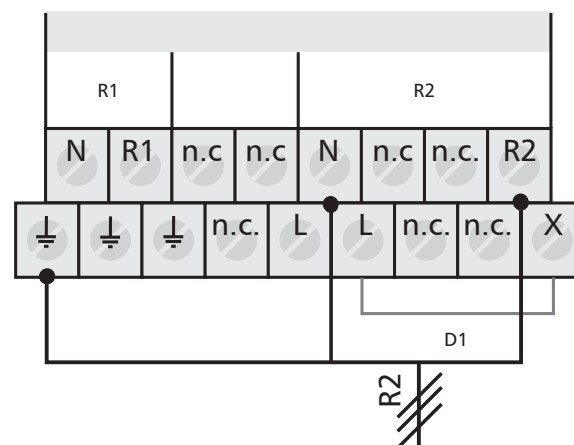

- Potential-free output via electromechanical relay; wire bridge must be removed!

DANGER

Risk of death by electrocution!

- ▶ In the event of use as a potential-free output, it must be ensured that the connections cannot come into contact with the mains voltage.

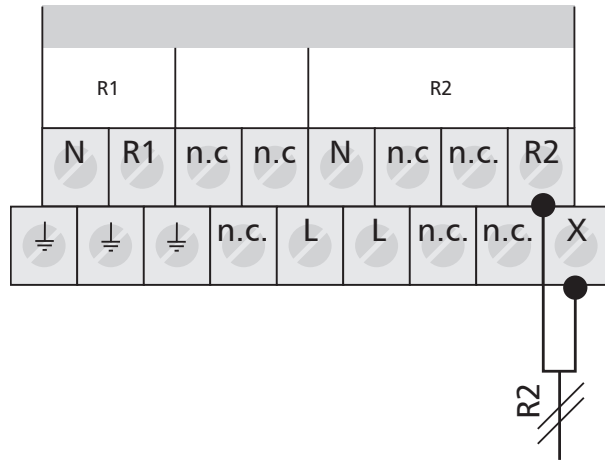

R1: output 1
R2: output 2

5 Commissioning

- ▶ Make sure that the installation is finished completely and correctly, and that the switch on the controller is set to "OFF".
 - ⇒ *The display for setting the language appears.*

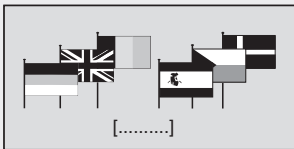

Display: 5.1
[Deutsch]

5.1 Setting the language

- ✓ "Deutsch" flashes in the display.
- ▶ $\triangle \nabla$: select a language.
- ▶ **SET**: confirm the language.
- ▶ **ESC**: finish the settings.
 - ⇒ *The display for setting the system group appears.*

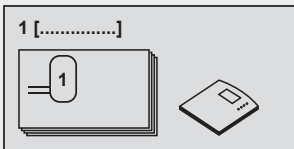

Display: 1.1
[Storage tank]

5.2 Setting the system group

NOTE

For an overview of systems, see chapter 7.1 "Systems".

- ✓ *The first system group (1 storage tank system) appears in the display.*
- ▶ $\triangle \nabla$: select a system group.
- ▶ **SET**: confirm the system group.
 - ⇒ *The display for setting the system appears.*

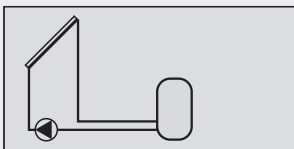

Display: 1.1.1

5.3 Setting the system

- ✓ *The first system in the selected system group appears in the display.*
- ▶ $\triangle \nabla$: select a system.
- ▶ **SET**: confirm the system.
 - ⇒ *In the display, a small checkmark appears below the item number, which confirms that the system is selected.*
- ▶ **ESC**: exit the settings menu.
 - ⇒ *The commissioning is finished.*

6 Modes of operation

6.1 "OFF" mode

- ▶ In order to switch off the outputs, slide the operating switch down.
 - ⇒ A new window appears in the display, which shows "OFF", as well as the controller software version number and the number of the chosen system. The display is backlit in red.

In "OFF" mode, all outputs (R1, R2) are switched off.

NOTE

On delivery from the manufacturer, the switch is set to "OFF".

6.2 "Automatic" mode

CAUTION

Damage to pump caused by dry operation!

The controller may only be set to "Automatic" when the system has been filled.

- ▶ In order to switch the outputs to "Automatic", slide the operating switch to the middle position.
 - ⇒ The status appears in the display.

This mode of operation is the automatic controller mode and must be set for automatic operation.

NOTE

- ▶ During normal system operation, the operating switch should always be set to "Automatic".

6.3 "Manual" mode

CAUTION

Damage to pump caused by dry operation!

The controller may only be set to "Manual" when the system has been filled.

When operating the device for the first time, or when testing the function, the controller outputs can be manually switched.

- ▶ In order to switch the outputs manually, slide the operating switch up.
 - ⇒ The display is backlit in red and a settings window is displayed.
- ▶ $\triangle \nabla$: choose the desired output.
- ▶ **SET**: switch the selected output to "on" or "off".
- ▶ **ESC**: close the settings window.
 - ⇒ The current recorded values can now also be queried for the purpose of checking.
- ▶ $\triangle \nabla$: access measured values.
- ▶ **SET**: reopen the settings window.

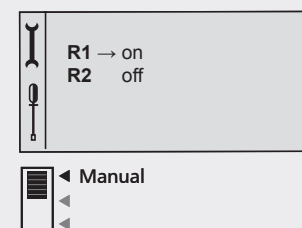
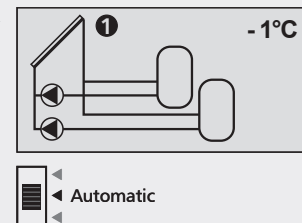
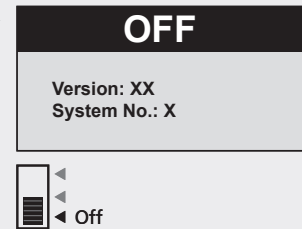

7 Settings

Menu overview, see following double page

7.1 Systems

The desired solar energy system can be chosen using the "System" submenu. There are a total of 4 different systems to choose from (subdivided into 2 system groups).

System group	4 systems	Chapter
Systems with one storage tank	System 1: 1 collector array – 1 storage tank	7.2.1
	System 2: 1 collector array - 1 storage tank - heating return increase	
	System 3: 1 collector array - 1 storage tank with external heat exchanger	
Systems with two storage tanks	System 4: 1 collector array – 2 storage tanks – intelligent pump control	7.2.2

NOTE

Upon selection of a new system, the functions, storage tank priority, and parameters are automatically returned to their factory settings.

- ▶ Check the settings again!

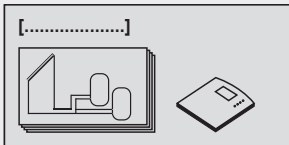

Display: 1

[Systems]

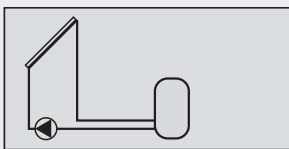

Sample display

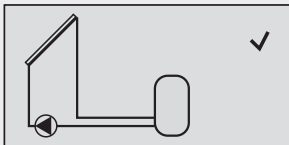

Sample display

Selecting a system

- ▶ **SET:** press button for approx. 2 sec.
- ▶ $\Delta \nabla$: select the menu item "Systems".
- ▶ **SET:** open the submenu "System groups".
- ▶ $\Delta \nabla$: Select a system group.
- ▶ **SET:** press button to confirm.
- ▶ $\Delta \nabla$: select a system.
- ▶ **SET:** press button to confirm.
- ⇒ *In the display, a small checkmark appears below the item number, which confirms that the system is selected.*
- ▶ **ESC:** exit the "Systems" menu item.

Menu overview

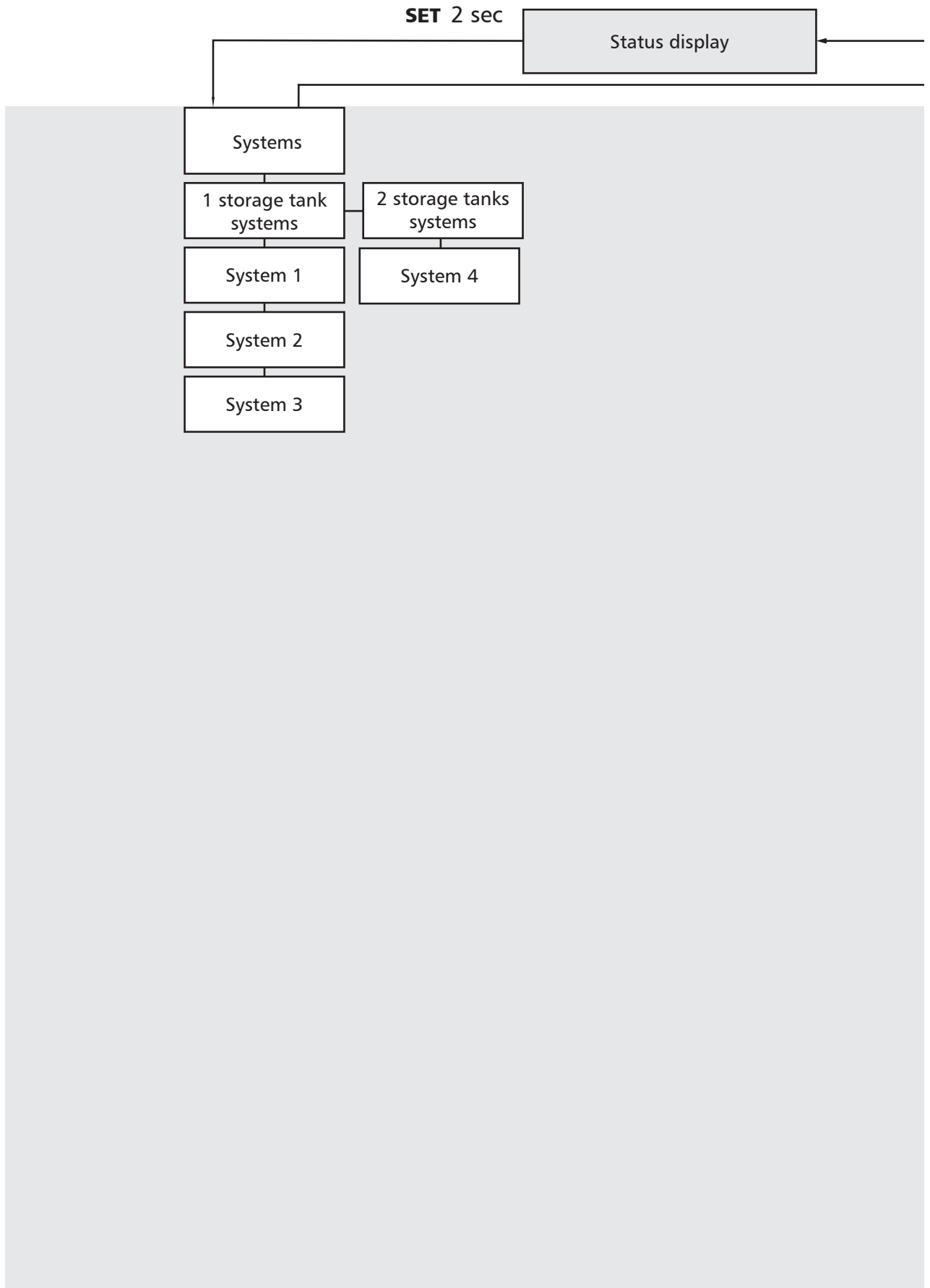

ESC

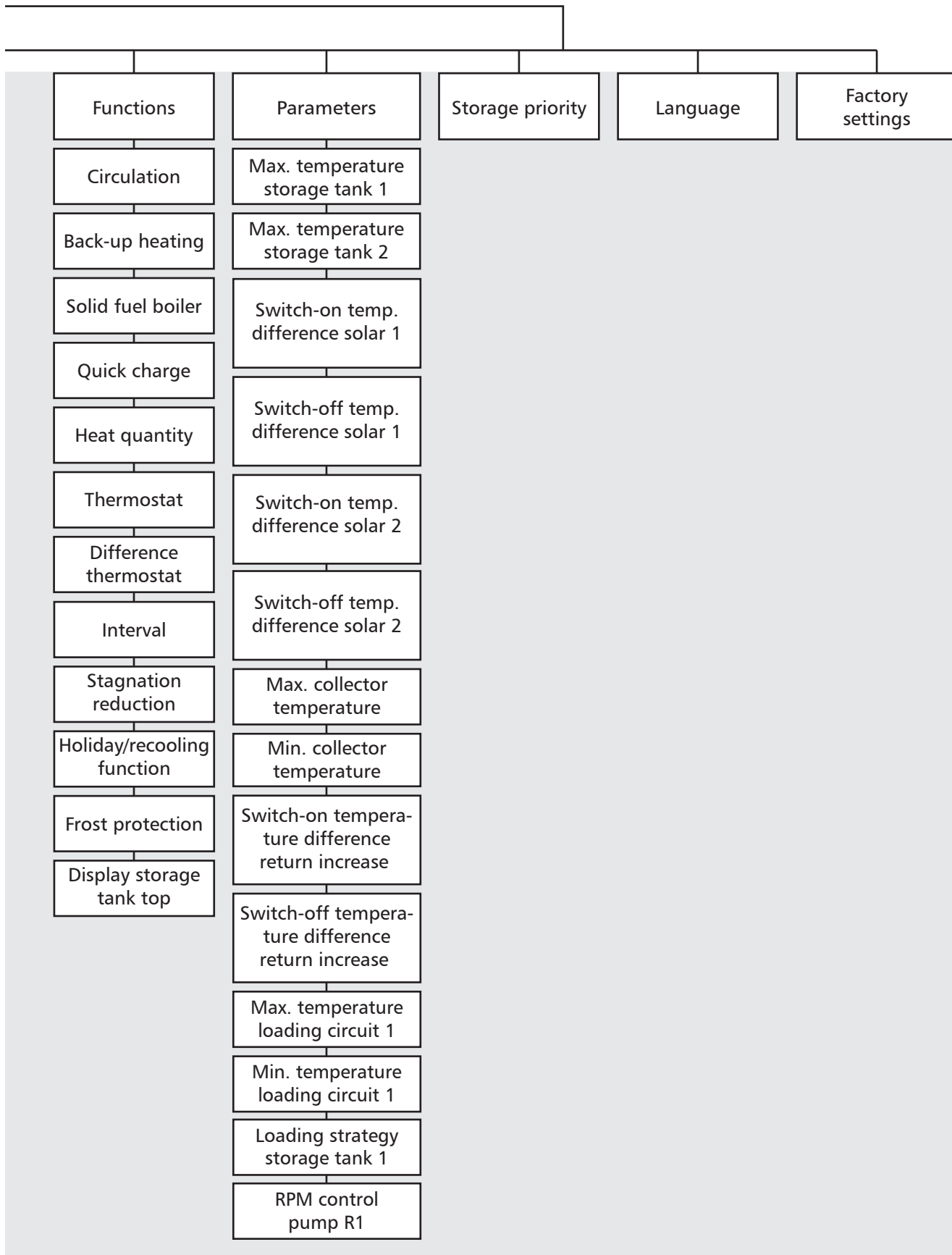

7.2.1 Systems with one storage tank

System 1: 1 collector array - 1 storage tank

Description of the solar function: The solar circuit pump R1 is switched on as soon as the switch-on temperature difference between collector array A1 (T1) and storage tank B1 (T2) is reached. When the switch-off temperature difference between collector array A1 (T1) and storage tank B1 (T2) or a safety limit is reached, the solar circuit pump R1 is switched off again.

Loading strategy of solar circuit pump R1: In the factory, temperature differential control is chosen as the loading strategy for the storage tank B1. It can be adjusted or changed to target temperature control using the "Parameters" menu (chapter 7.3 "Parameters").

Activating the system: see chapter 7.1. "Selecting a system"

Terminal layout

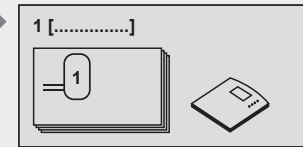
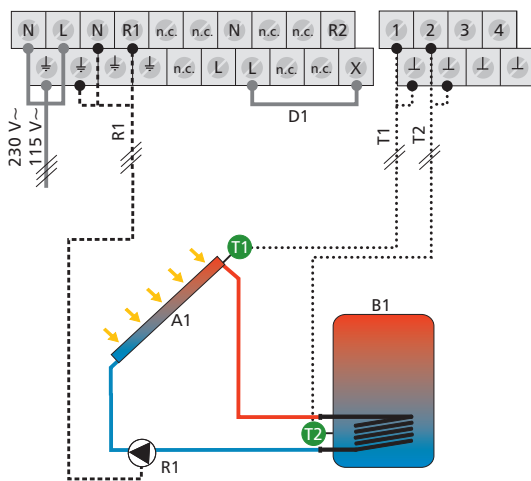

Display: 1.1

[Storage tank]

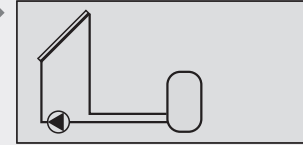

Display: 1.1.1

- A1: collector array
- B1: storage tank
- D1: wire bridge
- R1: solar circuit pump
- T1: collector sensor
- T2: lower area of storage tank

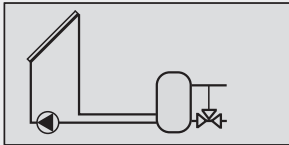

Display: 1.1.2

System 2: 1 collector array – 1 storage tank – heating return increase

Description of the solar function: The solar circuit pump R1 is switched on as soon as the switch-on temperature difference between the collector array A1 (T1) and the storage tank B1 (T2) is reached. When the switch-off temperature difference between the collector array A1 (T1) and the storage tank B1 (T2) or a safety limit is reached, the solar circuit pump R1 is switched off again.

Description of the heating return increase: The 3-way valve R2 in the heating return is switched on (water flows through storage tank) as soon as the switch-on temperature difference between the storage tank B1 (T3) and the heating return (T4) is reached. When the switch-off temperature difference (T3 – T4) is reached, the 3-way valve R2 returns to its initial state. Water does not flow through the storage tank.

NOTE

When no voltage is on the system, the switching valve R2 must be set in such a manner that water does **not** flow through the storage tank.

Loading strategy of solar circuit pump R1: In the factory, temperature differential control is chosen as the loading strategy for the storage tank B1. It can be adjusted or changed to target temperature control using the "Parameters" menu (chapter 7.3 "Parameters").

Activating the system: see chapter 7.1. "Selecting a system"

Terminal layout

- A1: collector array
- B1: storage tank
- D1: wire bridge
- R1: solar circuit pump
- R2: switching valve heating return increase
- T1: collector sensor
- T2: lower area of storage tank
- T3: sensor storage tank heating return increase
- T4: sensor heating return increase

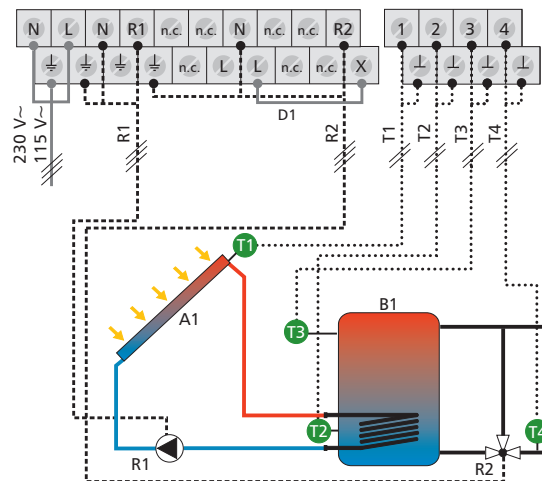

System 3: 1 collector array - 1 storage tank with external heat exchanger

Description of the solar function: The solar circuit pump R2 is switched on as soon as the switch-on temperature difference between the collector array A1 (T1) and the storage tank B1 (T2) is reached. When the switch-off temperature difference or a safety limit is reached, the solar circuit pump R2 switches off again. The storage tank loading pump R1 is switched on as soon as the switch-on temperature difference between the external heat exchanger F1 (T3) and the storage tank B1 (T2) is reached. The storage tank is loaded until the switch-off temperature difference between the external heat exchanger F1 (T3) and the storage tank B1 (T2) is reached, or until a safety limit is reached.

Loading strategy of solar circuit pump R1: In the factory, target temperature control is chosen as the loading strategy for the storage tank B1. It can be adjusted or changed using the "Parameters" menu (chapter 7.3 "Parameters").

Loading strategy of solar circuit pump R2: It is not possible to select whether temperature difference control or target temperature control is to be used as the loading strategy. Solar circuit pump R2 operates according to the switch-on and switch-off temperature difference parameter values.

Activating the system: see chapter 7.1. "Selecting a system".

Terminal layout

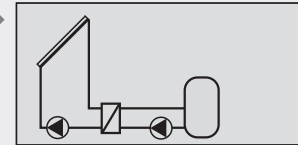
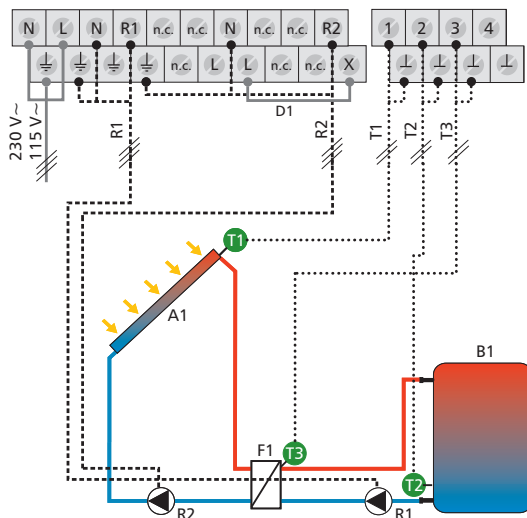

Display: 1.1.3

- A1: collector array
- B1: storage tank
- D1: wire bridge
- F1: external heat exchanger
- R1: storage tank loading pump
- R2: solar circuit pump
- T1: collector sensor
- T2: lower area of storage tank
- T3: sensor ext. heat exchanger

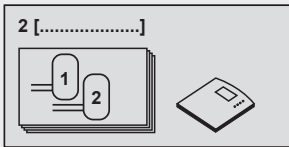

Display: 1.2

[Storage tank]

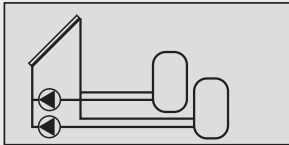

Display: 1.2.1

7.2.2 Systems with two storage tanks

System 4: 1 collector array – 2 storage tanks – intelligent pump control

Description of the solar function: When the switch-on temperature difference between the collector array A1 (T1) and one of the two storage tanks B1, B2 (T2, T3) is reached, the appropriate solar circuit pump R1 or R2 is switched on. Both storage tanks B1, B2 are loaded one after the other, according to the priority control (chapter 7.4 "Storage tank priority"), until either the relevant switch-off temperature difference between the collector array A1 (T1) and storage tanks B1, B2 (T2, T3) is reached, or a safety limit is reached.

Loading strategy of solar circuit pump R1: In the factory, temperature differential control is chosen as the loading strategy for storage tank B1. It can be adjusted or changed to target temperature control using the "Parameters" menu (chapter 7.3 "Parameters").

Loading strategy of solar circuit pump R2: It is not possible to select whether temperature differential control or target temperature control is to be used as the loading strategy for storage tank B2. Solar circuit pump R2 operates according to the switch-on and switch-off temperature difference parameter values.

Activating the system: see chapter 7.1. "Selecting a system".

Terminal layout

- A1: collector array
- B1: storage tank 1
- B2: storage tank 2
- D1: wire bridge
- R1: solar circuit pump 1
- R2: solar circuit pump 2
- T1: collector sensor
- T2: sensor lower area of storage tank 1
- T3: sensor lower area of storage tank 2

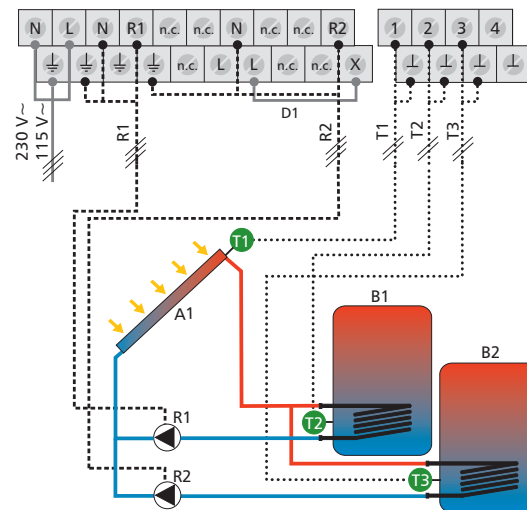

7.2 Functions

Additional controller settings can be made by using the "Functions" submenu.

The following submenus can be opened using the "Functions" menu item:

- Circulation 7.3.2
- Back-up heating 7.2.3
- Solid fuel boiler 7.2.4
- Quick charge 7.2.5
- Heat quantity 7.2.6
- Thermostat 7.2.7
- Difference thermostat 7.2.8
- Interval 7.2.9
- Stagnation reduction 7.2.10
- Holiday function / recooling 7.2.11
- Frost protection 7.2.12
- Display storage tank top 7.2.13

An overview of the factory settings and the ranges of possible settings can be found in the table in chapter 13.3 "Parameter values for functions".

7.2.1 Accessing a function

Before making settings within a function, you must perform the following steps:

Selecting a function

- ▶ **SET:** press button for approx. 2 sec.
- ▶ $\triangle \nabla$: select the menu item "Functions".
- ▶ **SET:** open the submenu "Functions".
- ▶ $\triangle \nabla$: select a function.

Activating / deactivating the function

- ▶ **SET:** press button.
 - ⇒ *The display for activating (on) or deactivating (off) the function is shown.*
- ▶ **SET:** press button for approx. 2 sec.
 - ⇒ *The function is activated or deactivated.*

NOTE

An information window is displayed if the function cannot be activated (see chapter 10 "Information windows").

Selecting an output

- ▶ ∇ : press button.
 - ⇒ *The display for setting the output appears.*
- ▶ **SET:** press button.
 - ⇒ *Output (?) flashes.*
- ▶ $\triangle \nabla$: choose the desired output.
- ▶ **SET:** press button to confirm.

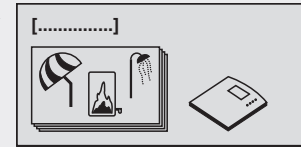

Display: 2
[Function]

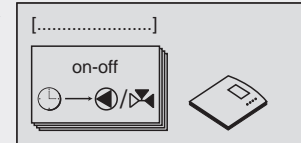

[Time function]

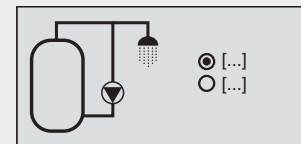

[off]
[on]



Sample display

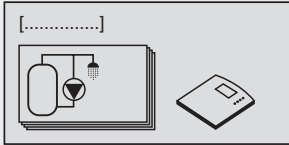

Display: 2.1
[Circulation]

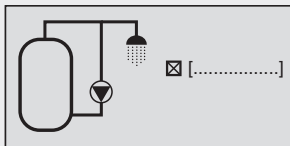

Display: 2.1.3
[Temp. controlled]

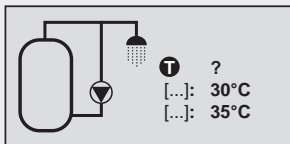

Display: 2.1.3.1
[on]
[off]

NOTE

R? or T? indicates an output or input which has not yet been selected. Only outputs which are not yet required by the respective system can be selected. Double allocation of outputs is not possible. However, double allocation of inputs is possible. This is also displayed in an information window (see chapter 10).

Leaving the menu

- ▶ **ESC:** press button.

7.2.2 Circulation function

A circulation pump can be controlled in a temperature-based or pulse-based manner. These types of control can also be combined with each other.

Temperature control: when the temperature in the circulation return falls below the "on" value, then the pump is switched on until the "off" temperature is reached.

NOTE

In order to avoid measurement errors caused by the pipe's thermal conduction, a minimum clearance space of 1.50 m from the storage tank should be observed when installing the circulation sensor.

Pulse control: when the circulation function is requested via a pulse (e.g. from a flow switch), the pump runs for the set circulation duration. Subsequently, no further requests are accepted until the set wait time has expired.

Activating temperature control

- ✓ "Functions" submenu selected, see "Selecting a function" (chapter 7.2.1).
- ✓ Circulation activated, see "Activating a function" (chapter 7.2.1).
- ✓ Outputs selected, see "Selecting an output" (chapter 7.2.1).
- ▶ ▽: press button.
 - ⇒ The "Temp. controlled" display appears.
- ▶ **SET:** press button.
 - ⇒ Temperature control is activated.
- ▶ ▽: press button.
 - ⇒ The display for setting the temperature input and the "on" and "off" values appears.
- ▶ **SET:** press button.
 - ⇒ "T" flashes in the display (circulation pipe temperature input).
- ▶ △▽: choose the desired input.
- ▶ **SET:** press button to confirm.
 - ⇒ The "on" value flashes after confirmation of the temperature sensor.
- ▶ △▽: set the "on" value.
- ▶ **SET:** press button to confirm.
 - ⇒ The "off" value flashes after confirmation of the "on" value.
- ▶ △▽: set the "off" value.
- ▶ **SET:** press to confirm and close.
 - ⇒ The settings are saved.

Activating pulse control

- ✓ "Functions" submenu selected, see "Selecting a function" (chapter 7.2.1).
- ✓ Circulation activated, see "Activating a function" (chapter 7.2.1).
- ✓ Outputs selected, see "Selecting an output" (chapter 7.2.1).
- ▶ ▽: press button.
 - ⇒ The "Pulse controlled" display appears.
- ▶ **SET:** press button.
 - ⇒ Pulse control is activated.
- ▶ ▽: press button.
 - ⇒ The display for setting the pulse input, circulation time, and wait time appears.
- ▶ **SET:** press button.
 - ⇒ Pulse input flashes.
- ▶ △▽: choose the desired output.
- ▶ **SET:** press button to confirm.
 - ⇒ The circulation duration flashes after confirmation of the input.
- ▶ △▽: set the circulation duration.
- ▶ **SET:** press button to confirm.
 - ⇒ The wait time flashes after confirmation of the circulation duration.
- ▶ △▽: set the wait time.
- ▶ **SET:** press button to confirm the wait time and close.
 - ⇒ The settings are saved.
- ▶ **ESC:** leave the "Circulation" submenu.

7.2.3 Back-up heating function

This function allows thermostatic control of an output for additional heating of the solar storage tank using an oil or gas burner.

Temperature control: When the temperature in the upper part of the storage tank falls below the "on" value, then the output is switched on until the "off" temperature is reached.

Choosing the input and setting the temperature limits

- ✓ "Functions" submenu selected, see "Selecting a function" (chapter 7.2.1).
- ✓ Back-up heating activated, see "Activating a function" (chapter 7.2.1).
- ✓ Outputs selected, see "Selecting an output" (chapter 7.2.1).
- ▶ ▽: press button.
 - ⇒ The display for setting the temperature input and the "on" and "off" values appears.
- ▶ **SET:** press button.
 - ⇒ "T" flashes in the display (storage tank temperature input).
- ▶ △▽: choose the desired output.
- ▶ **SET:** press button to confirm.
 - ⇒ The "on" value flashes in the display.
- ▶ △▽: set the "on" value.
- ▶ **SET:** press button to confirm.
 - ⇒ The "off" value flashes after confirmation of the "on" value.
- ▶ △▽: set the "off" value.
- ▶ **SET:** press button to confirm.
 - ⇒ The settings are saved.

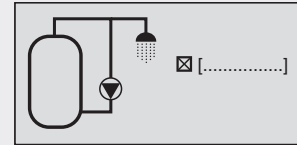

Display: 2.1.4

[Pulse controlled]

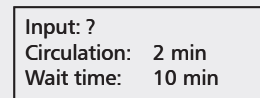

Display: 2.1.4.1

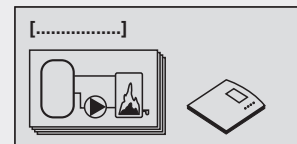

Display: 2.2

[Back-up heating]

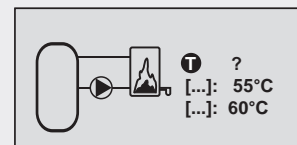

Display: 2.2.3

[on]
[off]

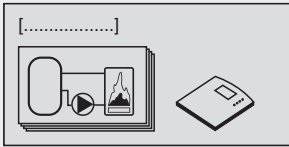

Display: 2.3

[Solid fuel boiler]

7.2.4 Solid fuel boiler function

This function allows control of a pump for heating of a storage tank using a solid fuel boiler.

When the temperature difference between the solid fuel boiler and the storage tank exceeds the "on" value, the solid fuel boiler temperature is above the "min" value, and the storage tank temperature is below the "max" value, then the pump is switched on. The pump runs until the temperature difference is lower than the "off" value, the solid fuel boiler temperature falls below the "min" value, or the storage tank temperature reaches the "max" value.

Allocating inputs and setting storage tank/solid fuel boiler temperature and switch-on/switch-off temperature difference

- ✓ "Functions" submenu selected, see "Selecting a function" (chapter 7.2.1).
- ✓ Solid fuel boiler activated, see "Activating a function" (chapter 7.2.1).
- ✓ Outputs selected, see "Selecting an output" (chapter 7.2.1).
- ▶ ▽: press button.
 - ⇒ The display for setting the temperature inputs and the switch-on/switch-off temperature difference appears.
- ▶ **SET**: press button.
 - ⇒ "T" flashes in the display (storage tank temperature input).
- ▶ △▽: choose the desired output.
- ▶ **SET**: press button to confirm.
 - ⇒ "T" flashes in the display (solid fuel boiler temperature input).
- ▶ △▽: choose the desired output.
- ▶ **SET**: press button to confirm.
 - ⇒ The "on" value flashes in the display.
- ▶ △▽: set the "on" value.
- ▶ **SET**: press button to confirm.
 - ⇒ The "off" value flashes after confirmation of the "on" value.
- ▶ △▽: set the "off" value.
- ▶ **SET**: press button to confirm.
 - ⇒ The settings are saved.

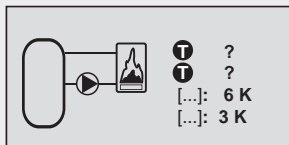

Display: 2.3.3

[on]
[off]

Programming the temperature limits of the solid fuel boiler and the storage tank

- ▶ ▽: press button.
 - ⇒ The display for setting the temperature limits for storage tank and solid fuel boiler appears.
- ▶ **SET**: press button.
 - ⇒ "max" flashes in the display (storage tank's maximum temperature value).
- ▶ △▽: set the "max" value.
- ▶ **SET**: press button to confirm.
 - ⇒ "min" flashes in the display (solid fuel boiler's minimum temperature value).
- ▶ △▽: set the "min" value.
- ▶ **SET**: press button to confirm.
 - ⇒ The settings are saved.



Display: 2.3.4

7.2.5 Quick charge function

This function attempts to load the upper part of the storage tank more quickly by means of a higher loading temperature in order to prevent conventional boiler back-up heating as early as possible.

When the temperature in the upper part of the storage tank falls below the "on" value, the loading strategy of storage tank 1 switches from differential loading to target temperature loading. The controller's RPM control is then used with the objective of loading the storage tank at a higher temperature level.

Setting the input for the upper part of the storage tank, and switch-on/switch-off temperatures

- ✓ "Functions" submenu selected, see "Selecting a function" (chapter 7.2.1).
- ✓ Quick charge function activated, see "Activating a function" (chapter 7.2.1).
- ▶ ▽: press button.
 - ⇒ The display for setting the temperature input and the "on" and "off" values appears.
- ▶ **SET:** press button.
 - ⇒ "T" flashes in the display (upper storage tank temperature input).
- ▶ △▽: choose the desired output.
- ▶ **SET:** press button to confirm.
 - ⇒ The quick charge function's "on" value flashes in the display.
- ▶ △▽: set the "on" value.
- ▶ **SET:** press button to confirm.
 - ⇒ The "off" value flashes after confirmation of the "on" value.
- ▶ △▽: set the "off" value.
- ▶ **SET:** press button to confirm.
 - ⇒ The settings are saved.

NOTE

When the "on" value is adjusted, the "off" value is altered accordingly in order to maintain reliable quick charge functionality.

7.2.6 Heat quantity function

The controller has a function for measuring the quantity of heat. This allows, for instance, to record the quantity of heat fed into the storage tank from the solar energy system. To do this, the temperature of the supply and return, and the flow rate of the solar energy system must be recorded. The flow rate can be approximately calculated by means of the pump speed. Since the heat quantity depends on the proportion of glycol in the fluid, this also is accounted for in the calculations. From these values, the controller determines the quantity of heat and shows this in the display.

Setting the flow rate determination and the glycol proportion

- ✓ "Functions" submenu selected, see "Selecting a function" (chapter 7.2.1).
- ✓ Heat quantity activated, see "Activating a function" (chapter 7.2.1).
- ▶ ▽: press button.

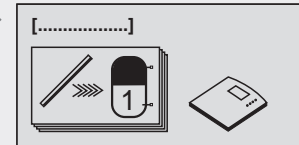

Display: 2.4

[Quick charge]

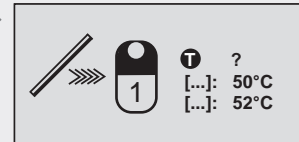

Display: 2.4.2

[on]
[off]

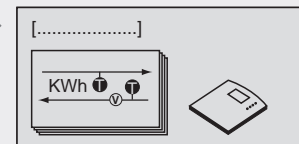

Display: 2.5

[Heat quantity]

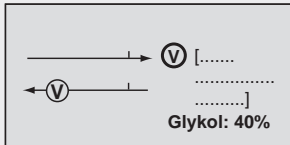

Display: 2.5.2

[Without flow sensor]

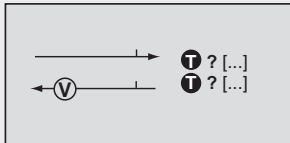

Display: 2.5.3

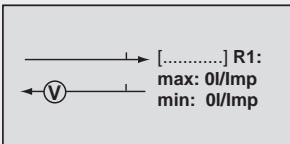
[hot]
[cool]

Display: 2.5.4

[Flow rate]

⇒ The display for setting the glycol proportion appears.

- ▶ **SET:** press button.
- ⇒ "Glycol proportion" flashes in the display.
- ▶ $\Delta \nabla$: set the value.
- ▶ **SET:** press button to confirm.
- ⇒ The settings are saved.

Allocating inputs for temperature sensors

- ▶ ∇ : press button.
- ⇒ The display for setting the temperature inputs appears.
- ▶ **SET:** press button.
- ⇒ "T" flashes in the display (input for supply temperature).
- ▶ $\Delta \nabla$: choose the desired output.
- ▶ **SET:** press button to confirm.
- ⇒ "T" flashes in the display (input for return temperature).
- ▶ $\Delta \nabla$: choose the desired output.
- ▶ **SET:** press button to confirm.

Determining the flow rate for the connected solar circuit pumps

- ▶ ∇ : press button.
- ⇒ The display for setting the min/max flow rate appears.
- ▶ **SET:** press button.
- ⇒ The "max" value flashes in the display and the pump begins to run at maximum speed.
- ▶ The flow rate value must now be read at the pump assembly's flow rate display.
- ▶ $\Delta \nabla$: enter the flow rate value.
- ▶ **SET:** press button to confirm.
- ⇒ The "min" value flashes in the display and the pump begins to run at minimum speed.
- ▶ The flow rate value must now be read at the pump assembly's flow rate display.
- ▶ $\Delta \nabla$: enter the flow rate value.
- ▶ **SET:** press button to confirm.

NOTE

- If other solar circuit pumps (e.g. system with 2 storage tanks) are connected to the controller, the flow rate for these pumps must be determined and entered as described here.
- If the minimum pump speed in the "Parameters" menu, or the pump level at the pump, is changed at a later point in time, the flow rate must be determined and set once more for more precise calculation of the heat quantity.
- If the collector is in a stagnant state, pump starts are blocked in order to prevent damage. A corresponding information window is displayed.

7.2.7 Thermostat function

This function allows a controller output to be controlled depending on a pre-defined temperature range. Depending on the temperature setting, the thermostat function can be activated either when the temperature falls below (heating) or rises above (cooling) a certain level.

If "on" value is higher than "off" value: If the temperature difference exceeds the defined "on" value, the output is switched on until the temperature difference falls below the "off" value.

If "on" value is lower than "off" value: If the temperature falls below the defined "on" value, the output is switched on until the temperature rises above the "off" value.

Defining the input and temperature values

- ✓ "Functions" submenu selected, see "Selecting a function" (see chapter 7.2.1).
- ✓ Thermostat activated, see "Activating a function" (chapter 7.2.1).
- ✓ Outputs selected, see "Selecting an output" (chapter 7.2.1).
- ▶ ▽: press button.
 - ⇒ The display for setting the temperature input and the "on" and "off" values appears.
- ▶ **SET:** press button.
 - ⇒ "T" flashes in the display (temperature input).
- ▶ △▽: choose the desired output.
- ▶ **SET:** confirm the input.
 - ⇒ The "on" value flashes in the display.
- ▶ △▽: set the "on" value.
- ▶ **SET:** press button to confirm.
 - ⇒ The "off" value flashes after confirmation of the "on" value.
- ▶ △▽: set the "off" value.
- ▶ **SET:** press button to confirm.
 - ⇒ The settings are saved.

NOTE

The "on" and "off" values must not be equal, as otherwise the thermostat remains inactive.

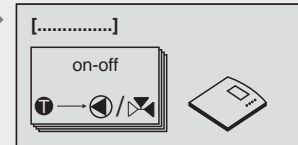

Display: 2.6

[Thermostat]

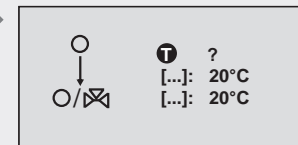

Display: 2.6.3

[on]

[off]

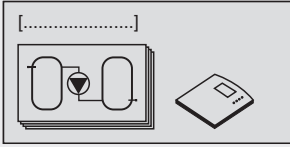

Display: 2.7

[Difference Thermostat]

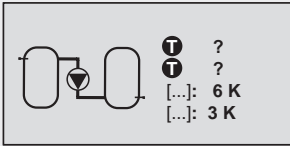

Display: 2.7.3

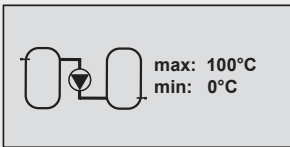
[on]
[off]

Display: 2.7.4

7.2.8 Difference thermostat function

This function allows a controller output to be controlled depending on a predefined temperature difference.

When the temperature difference exceeds the defined "on" value, the output is switched on until the temperature difference falls below the "off" value. For optimised functionality, unloading of the heat source can be limited to a particular temperature range, and loading of the heat target can be limited to a maximum value.

Defining the inputs and the switching values

- ✓ "Functions" submenu selected, see "Selecting a function" (chapter 7.2.1).
- ✓ Differential thermostat activated, see "Activating a function" (chapter 7.2.1).
- ✓ Outputs selected, see "Selecting an output" (chapter 7.2.1).
- ▶ ▽: press button.
 - ⇒ The display for setting the temperature inputs and the switching values appears.
- ▶ **SET:** press button.
 - ⇒ "T" flashes in the display (temperature input for the heat source).
- ▶ △▽: choose the (heat source's) input.
- ▶ **SET:** press button to confirm.
 - ⇒ "T" flashes in the display (temperature input for the heat target).
- ▶ △▽: choose the (heat source's) input.
- ▶ **SET:** press button to confirm.
 - ⇒ The "on" value flashes after confirmation of the heat target input.
- ▶ △▽: set the "on" value.
- ▶ **SET:** press button to confirm.
 - ⇒ The "off" value flashes after confirmation of the "on" value.
- ▶ △▽: set the "off" value.
- ▶ **SET:** press button to confirm.
 - ⇒ The settings are saved.

Defining limits for the heat source

- ▶ ▽: press button.
 - ⇒ The display for setting the limits (max, min) of the heat source appears.
- ▶ **SET:** press button.
 - ⇒ "max" flashes in the display (heat source's maximum value).
- ▶ △▽: set the maximum value.
- ▶ **SET:** press button to confirm.
 - ⇒ "min" (heat source's minimum value) flashes after confirmation of the maximum value.
- ▶ △▽: set the minimum value.
- ▶ **SET:** press button to confirm.
 - ⇒ The settings are saved.

Defining limits for the heat target

- ▶ ▽: press button.
 - ⇒ *The display for setting the limit of the heat target appears.*
- ▶ **SET:** press button.
 - ⇒ *"max" flashes in the display (heat target's maximum value).*
- ▶ △▽: set the maximum value.
- ▶ **SET:** press button to confirm.

7.2.9 Interval function

With some types of collector, the collector's construction does not allow the temperature to be recorded at the appropriate location. In these cases, the solar circuit must be briefly activated at regular intervals to transmit the actual heat from the collector pipe to the collector sensor. When the interval function is activated, the controller automatically switches the pump on according to the settings.

Setting the interval function

- ✓ *"Functions" submenu selected, see "Selecting a function" (chapter 7.2.1).*
- ✓ *Interval activated, see "Activating a function" (chapter 7.2.1).*
- ▶ ▽: press button.
 - ⇒ *The display for setting the interval time and the test time appears.*
- ▶ **SET:** press button.
- ▶ △▽: set the interval duration.
- ▶ **SET:** press button to confirm.
 - ⇒ *After confirmation of the "Interval" duration, the "Test" duration (duration for which the pump is switched on) flashes.*
- ▶ △▽: set the test duration.
- ▶ **SET:** press button to confirm.
 - ⇒ *The settings are saved.*

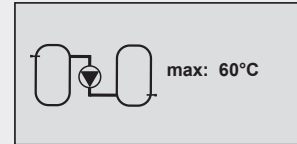

Display: 2.7.5

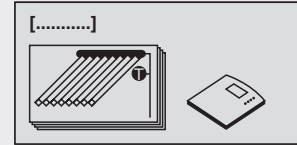

Display: 2.8

[Interval]

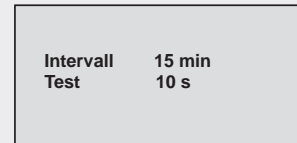

Display: 2.8.2

[Interval]

[Test]

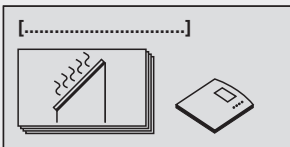

Display: 2.9

[Stagnation reduction]

7.2.10 Stagnating reduction function

This function delays the end of the storage tank's loading phase in order to reduce, or even to avoid, the system's stagnation times at high temperatures. This causes the pump to be stopped repeatedly, and only briefly switched on again when high collector temperatures arise. With higher collector temperatures, the efficiency decreases significantly, thus loading takes longer. This delays the beginning of any stagnation time. Stagnation reduction can only be activated or deactivated.

NOTE

It is possible that this causes the storage tank to be loaded with a higher solar temperature. However, the set maximum storage tank temperature always has priority. This continues to be observed, as do other safety limits.

Activating the stagnation reduction function

- ✓ "Functions" submenu selected, see "Selecting a function" (chapter 7.2.1).
- ✓ Stagnation reduction function activated, see "Activating a function" (chapter 7.2.1).

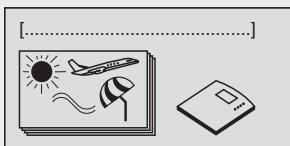

Display: 2.10

[Holiday function / recooling]

7.2.11 Holiday function/recooling

If the user extracts too little hot water, or none at all (e.g. during holidays), a completely heated storage tank can cause the solar energy system to begin evaporation prematurely, and the system is thus subjected to a higher thermal load.

When the holiday function is activated, and the temperature in the storage tank reaches 10 K below the set maximum storage tank temperature, the controller attempts to systematically unload the lower part of the storage tank, until the set minimum storage tank temperature is reached.

Defining the minimum storage tank temperature

- ✓ "Functions" submenu selected, see "Selecting a function" (chapter 7.2.1).
- ✓ Holiday function/recooling activated, see "Activating a function" (chapter 7.2.1).
- ▶ ▽: press button.
 - ⇒ The display for setting the minimum storage tank temperature appears.
- ▶ **SET**: press button.
 - ⇒ The min value flashes.
- ▶ △▽: Set the minimum temperature value for the storage tank.
- ▶ **SET**: press button to confirm.



Display: 2.10.2

NOTE

This function should only be activated during long periods of absence. When you return, please deactivate this function in order to avoid unnecessary wastage of energy via the collector circuit.

7.2.12 Frost protection function

When the frost protection function is activated, the solar circuit pump is switched on as soon as the collector temperature sinks below +5 °C. This causes heat to be pumped through the collector from the lower part of the storage tank in an attempt to prevent the collector from freezing.

If the collector reaches a temperature of +7 °C, the pump is switched off again.

This function is only useful in systems without anti-freeze in the heat transfer fluid.

The frost protection function can only be activated or deactivated.

Activating the frost protection function

- ✓ "Functions" submenu selected, see "Selecting a function" (chapter 7.2.1).
- ✓ Frost protection function activated, see "Activating a function" (chapter 7.2.1).

CAUTION

System can freeze despite the activated frost protection function!

- During a power outage (frost protection function does not operate.)
- In the event of a break or short circuit in a collector sensor or cable.
- During long-term periods of frost (due to restricted water tank heat storage).
- If collectors are mounted in locations exposed to wind.
- ▶ If frost is expected for a long period of time, only operate the system with heat transfer fluid. It is recommended to generally use heat transfer fluid with anti-freeze for solar energy systems.

7.2.13 Display storage tank top function

The display storage tank top function serves merely as an additional display and has no effect on control.

- ✓ "Functions" submenu selected, see "Selecting a function" (chapter 7.2.1).
- ✓ Display storage tank top activated, see "Activating a function" (chapter 7.2.1).
- ▶ ▽: press button.
 - ⇒ The display for selecting the storage tank and the corresponding temperature sensor appears.
- ▶ **SET:** press button.
 - ⇒ The upper temperature sensor flashes in the display.
- ▶ △▽: set the temperature sensor.
- ▶ **SET:** press button to confirm.
 - ⇒ The storage tank selection flashes in the display.
- ▶ △▽: set the storage tank.
- ▶ **SET:** press button to confirm.

NOTE

There are two "storage tank top" settings available, which are independent of one another.

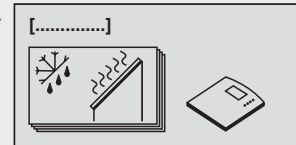

Display: 2.11

[Frost protection]

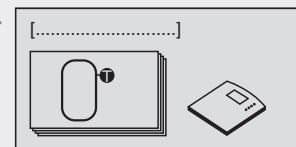

Display: 2.12

[display storage tank top]

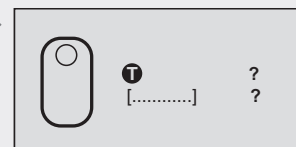

Display: 2.12.2/3

[storage tank]

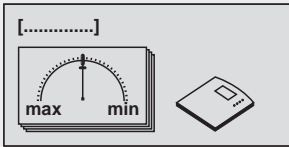

Display: 3
[Parameters]

7.3 Parameters

In the factory, the controller is configured in such a manner that it can be used in most applications without changes to these values.

All parameters can be modified to a certain extent to suit the individual requirements of the system. If modifications are realised, the operating data of the solar components used must be observed!

NOTE

The parameter settings depend on the solar energy system chosen. This means that not all parameter settings are available for all types of solar energy systems.

The following parameters can be accessed and adjusted:

- maximum temperature storage tank 1, storage tank 2
- switch-on temperature difference solar 1, solar 2
- switch-off temperature difference solar 1, solar 2
- maximum collector temperature
- minimum collector temperature
- switch-on temperature difference return increase
- switch-off temperature difference return increase
- maximum temperature loading circuit 1
- minimum temperature loading circuit 1
- loading strategy storage tank 1
- RPM control pump R1

7.3.1 Accessing and adjusting parameters

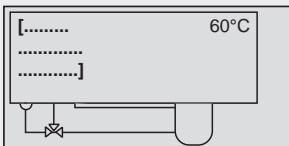

Sample display
[maximum
temperature
storage tank 1]

Accessing parameters

- ▶ **SET:** press button for approx. 2 sec.
- ▶ $\Delta \nabla$: select the menu item "Parameters".
- ▶ **SET:** open the submenu.
- ▶ $\Delta \nabla$: select a parameter.

Setting a parameter value

✓ Submenu "Parameters" selected (see "Accessing parameters").

- ▶ **SET:** press button.
 - ⇒ *The display with the selected system and the corresponding parameter value flashes.*
- ▶ $\Delta \nabla$: set the value.
- ▶ **SET:** press button to confirm.

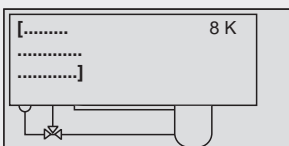

Sample display
[loading
strategy
of storage tank 1]

Exiting the parameter

- ▶ **ESC:** press button to confirm.

NOTE

The "loading strategy" and "RPM control" parameters can be adjusted as follows.

7.3.2 Setting the loading strategy parameter

✓ Access the "loading strategy" parameters, (see chapter 7.3.1).

▶ **SET:** press button.

⇒ The display for setting the temperature differential control or target temperature control appears.

Choosing loading strategy between temperature differential control and target temperature control

▶ **SET:** press button for approx. 2 sec.

⇒ Select either temperature differential control (dT) or target temperature control (T).

Setting the temperature differential value or target temperature value

▶ **SET:** press button.

⇒ The temperature differential value flashes in the display (e.g. $dT=8\text{ K}$).

▶ $\Delta\nabla$: set the temperature differential value.

▶ **SET:** press button to confirm.

⇒ The target temperature value flashes in the display (e.g. $T=60\text{ }^\circ\text{C}$).

▶ $\Delta\nabla$: set the target temperature value.

▶ **SET:** press button to confirm.

⇒ The settings are saved.

7.3.3 Setting the RPM control parameter

✓ Access the "RPM control" parameter, (see chapter 7.31).

▶ **SET:** press button.

⇒ The display for activating (yes) or deactivating (no) the RPM control is shown.

Activating or deactivating the RPM control

▶ **SET:** press button for approx. 2 sec.

⇒ Choose between "yes" and "no" for RPM control.

Setting the minimum speed

▶ **SET:** press button.

⇒ The min. RPM value flashes.

▶ $\Delta\nabla$: set the minimum speed.

▶ **SET:** press button to confirm.

⇒ The settings are saved.

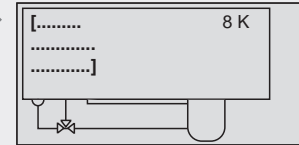

Display: 3.21

[loading strategy of storage tank 1]

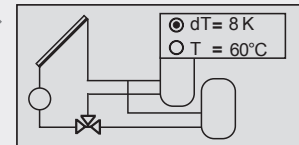

Display: 3.21 Settings window

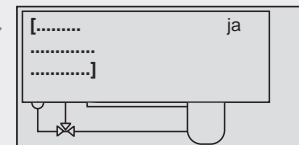

Display: 3.24

[RPM control pump R1]

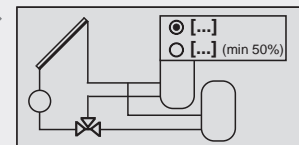

Display: 3.24 Settings window

[no]
[yes]

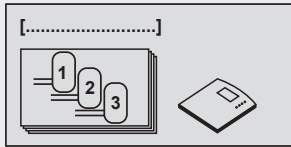

Display: 4
[Storage priority]

7.4 Storage priority

When a 2-storage-tank system is selected, the storage priority can also be specified.

When storage priority is **activated**, a first-priority storage tank and a second-priority storage tank can be defined. If it is intended that one of the two storage tanks is not to be loaded, this tank can be "removed" from the storage priority.

When storage tank priority is **deactivated** the storage tanks will be loaded equally.

Control

When storage priority is activated, the controller primarily attempts to load the first-priority storage tank. However, if this is initially impossible due to the collector temperature being too low, preference is given to loading the second-priority storage tank, if possible. In this event, the controller conducts regular tests (every 30 minutes) in order to check whether it has become possible to load the first-priority storage tank. This test can take several minutes, as the collector array must heat up sufficiently. On the basis of this heating process, the controller predicts whether it is possible to load the first-priority storage tank in a foreseeable period of time.

When storage priority is deactivated, the controller begins (if possible) to load the colder storage tank, and loads it until its temperature exceeds that of the other storage tank. Loading then switches to the other storage tank. Thus, both storage tanks are heated equally, in an alternating manner.

Accessing storage priority

- ▶ **SET:** press button for approx. 2 sec.
- ▶ $\triangle \nabla$: select the menu item "Storage priority".

Activating/deactivating storage priority

- ▶ **SET:** press button.
 - ⇒ *The display for activating (on) or deactivating (off) storage priority appears.*
- ▶ **SET:** press button for approx. 2 sec.
 - ⇒ *Storage priority is activated or deactivated.*

Specifying storage priority (if storage priority is activated)

- ▶ ∇ : press button.
 - ⇒ *The display for setting the storage priority appears.*
- ▶ **SET:** press button.
 - ⇒ *The storage priority flashes.*
- ▶ $\triangle \nabla$: set the storage priority.
- ▶ **SET:** press button to confirm.

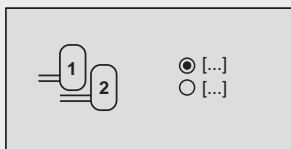

Display: 4.1
[off]
[on]

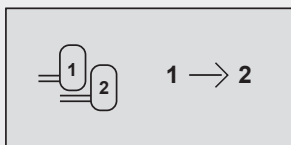

Display: 4.2

7.5 Language

Accessing and selecting the language

- ▶ **SET:** press button for approx. 2 sec.
- ▶ $\triangle \nabla$: select menu item "Language".
- ▶ **SET:** press button.
 - ⇒ *The language display appears.*
- ▶ **SET:** press button.
 - ⇒ *The set language flashes.*
- ▶ $\triangle \nabla$: select a language.
- ▶ **SET:** press button to confirm.

7.6 Factory settings

Resetting the factory settings

- ▶ **SET:** press button for approx. 2 sec.
- ▶ $\triangle \nabla$: select the menu item "Factory settings".
- ▶ **SET:** press button.
 - ⇒ *The display "Reset all values?" appears.*
- ▶ **SET:** press button.
 - ⇒ *All values are reset to the factory settings.*
 - The controller restarts. The controller must now be reconfigured (see chapter 5 "Commissioning").*

NOTE

When the controller is reset to factory settings, all settings return to the values they had upon delivery of the controller.

The following values are retained:

- The min/max values of the temperature sensors
- The outputs' operating hours
- Max. heat output
- Heat quantities

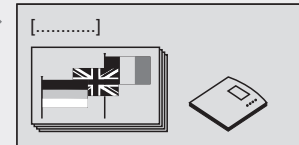

Display: 5

[Language]

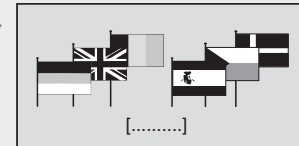

Display: 5.1

[Deutsch]

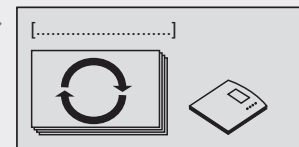

Display: 6

[Factory settings]



Display: 6.1

[Reset	[yes]
all	
values?]	[no]

8 Automatic operation

Symbols

In "Automatic" operation of the controller, the status display with the selected solar energy system and other set functions are shown on the display. You can access the values of the individual sensors, the outputs' running times, and additionally set functions, by using the operating buttons (arrow up and arrow down). Other symbols provide information on the condition of the solar system.

The various symbols are displayed as soon as additional functions are activated or values exceed or fall below parameters. The display message below shows all symbols simultaneously as an example. In practice, they appear in various combinations.

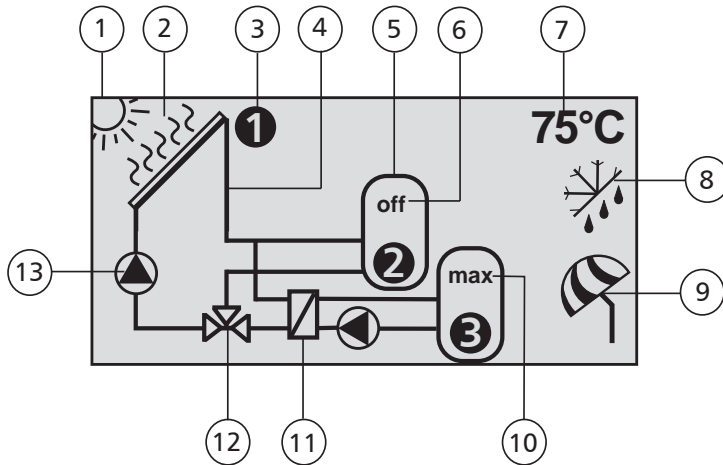

- | | |
|---|---|
| ① Symbol for solar circuit's switch-on condition fulfilled | ⑨ Symbol for the activated holiday/recooling function |
| ② Symbol for maximum collector temperature reached | ⑩ Symbol (max) for maximum storage tank temperature reached |
| ③ Symbol for the currently selected temperature sensor | ⑪ Symbol for external heat exchanger |
| ④ Symbol for the solar circuit | ⑫ Symbol for 3-way switching valve |
| ⑤ Symbol for the storage tank | ⑬ Symbol for pump |
| ⑥ Symbol (off) for deactivated storage tank | |
| ⑦ Display of the current measured value such as temperature values and outputs' operating hours | |
| ⑧ Symbol for the activated frost protection function | |

8.1 Status display

Switching the display screen

- ▶ $\triangle \nabla$: press button.
 - ⇒ *The following values and displays appear one after another:*
 - The temperature sensors of the system set, and the corresponding current temperature values.
 - Outputs and corresponding running times.
 - Functions, and their additional measured values.
 - ⇒ *The additionally set functions are displayed.*

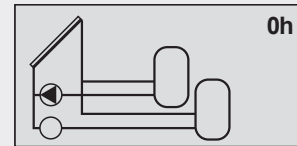

Sample display

8.2 Temperature sensor min/max display

Display of the min/max values

- ▶ $\triangle \nabla$: choose the desired temperature sensor.
- ▶ **SET**: access the information window.
 - ⇒ *The min/max values are displayed.*

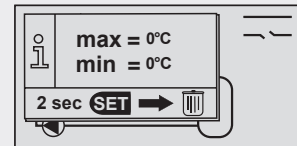

Sample display

Resetting the min/max values

- ▶ **SET**: press button for approx. 2 sec.
 - ⇒ *The min/max values are reset to the current temperature.*

NOTE

The minimum and maximum values of the connected temperature sensors are always logged and accessible.

The values stored can be reset at any time.

8.3 Operating hours display for pumps switching valves

Display of the operating hours

- ▶ $\triangle \nabla$: choose the desired pump or valve.
- ▶ **SET**: access the information window.
 - ⇒ *The hours-of-operation logger is displayed.*

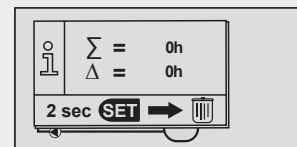

Sample display

Resetting the operating hours

- ✓ *Operating hours called up.*
- ▶ **SET**: press button for approx. 2 sec.
 - ⇒ *The delta value (Δ) is reset to zero.*

The outputs' operating hours are always stored.

Here, a distinction is made between total operating hours (Σ) and delta operating hours (Δ). The total operating hours cannot be reset. However, delta operating hours can be reset to zero at any time.

9 Fault finding

The controller is a quality product, conceived for years of continuous trouble-free operation. If a problem occurs, the cause of the problem often lies not in the controller but in the peripheral components. The following description of some causes of problems should help the installer and operator to isolate the problem so that the system can be repaired as quickly as possible and to avoid unnecessary costs. Of course, not all possible causes of problems can be listed here. However, here you will find the most common causes of problems that cover the majority of possible faults. Only return the controller when you are absolutely sure that none of the problems listed below is responsible for the fault.



DANGER

Risk of death by electrocution!

- ▶ All work on an open controller must be performed by professional personnel.
 - ▶ Remove the controller from the power supply before opening the case.
-

9.1 Causes of problems

Controller does not appear to function at all:

Secondary symptoms	Possible cause	Procedure
<ul style="list-style-type: none"> • Display shows nothing • No display illumination 	Controller power supply is interrupted	<ul style="list-style-type: none"> • Check the controller power cable • Check the fuse for the power supply • Check the fuse at the controller (replacement fuse is located in the case)

The solar pump does not operate, despite the fact that the switch-on conditions are satisfied:

Secondary symptoms	Possible cause	Procedure
The pump symbol in the display rotates	<ul style="list-style-type: none"> • Pump power supply is interrupted • Pump has seized up 	<ul style="list-style-type: none"> • Check the pump power cable • Check the fuse in the controller (replacement fuse is located in the case) • Get the pump working again, replace if necessary
The pump symbol in the display does not rotate	<ul style="list-style-type: none"> • The maximum storage tank temperature has been reached • The maximum collector temperature has been reached • In multi storage tank systems: the system has stopped due to a priority test • The minimum collector temperature has not been reached • The maximum loading temperature has been reached • Stagnation reduction activated • Storage tank deactivated 	<ul style="list-style-type: none"> • No fault
<ul style="list-style-type: none"> • The pump symbol in the display does not rotate • The display illumination is red • A tool symbol flashes in the display 	The operating switch is set to manual operation and the pump output is set to "off"	<ul style="list-style-type: none"> • Set the operating switch to automatic operation
<ul style="list-style-type: none"> • The pump symbol in the display does not rotate • The display illumination flashes red 	Short circuit or interruption of a temperature sensor	<ul style="list-style-type: none"> • On the controller, request the current values from all connected temperature sensors • Check all defective sensors and/or sensor cable

The solar pump operates, despite the fact that the switch-on condition is not fulfilled:

Secondary symptoms	Possible cause	Procedure
The pump symbol in the display rotates	<ul style="list-style-type: none"> The interval function is activated The holiday function is activated The frost protection function is activated Blockage protection is activated 	<ul style="list-style-type: none"> No fault Deactivate the relevant function, if necessary
<ul style="list-style-type: none"> Symbol rotates Display has a red background Tool symbol is visible on the display 	The operating switch is set to manual operation and the pump output is set to "on"	<ul style="list-style-type: none"> Set the operating switch to automatic operation

Solar pump is operating, activation condition is fulfilled, nevertheless, no heat transport in the solar circuit (no "fluid circulation"):

Secondary symptoms	Possible cause	Procedure
The pump symbol in the display rotates	<ul style="list-style-type: none"> Air is in the solar circuit The isolating valve is closed Limescale/contamination on solar circuit 	<ul style="list-style-type: none"> Check the solar circuit for air Check the isolating valve Flush/clean the solar circuit

Solar pump shows cycle behaviour

Secondary symptoms	Possible cause	Procedure
	<ul style="list-style-type: none"> Temperature difference too small Collector sensor incorrectly positioned 	<ul style="list-style-type: none"> Adjust temperature difference in the Parameters menu Check the collector sensor

9.2 Pt1000 temperature sensor values

A potentially defective sensor can be checked using an ohmmeter. To do this, the sensor must be disconnected, its resistance measured, and the value compared with the figures in the table below. Small deviations are acceptable.









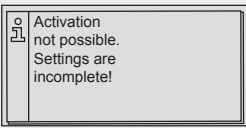
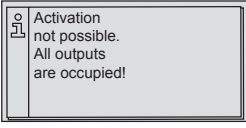
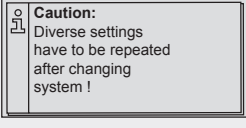
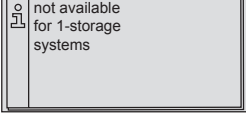
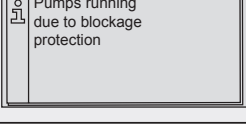
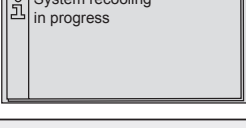
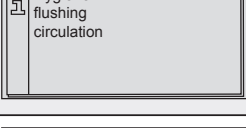
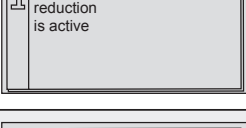
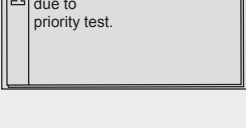
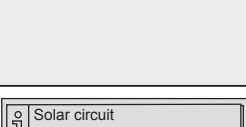

Temperature [°C]	-30	-20	-10	0	10	20	30	40	50	60	70
Resistance [Ω]	882	922	961	1000	1039	1078	1117	1155	1194	1232	1271

Temperature [°C]	80	90	100	110	120	130	140	150	160	170	180
Resistance [Ω]	1309	1347	1385	1423	1461	1498	1536	1573	1611	1648	1685

10 Information windows

The following information windows are displayed whenever a function's settings are not complete, activation of a function is not possible, errors occur in the system, or certain functions are currently activated.

Display	Description	Measures
	Function cannot be activated as the corresponding settings are incomplete. Function was deactivated again.	Check and complete the settings.
	Function cannot be activated, as all outputs are already occupied.	If the selected layout, or another function, is to be retained, this function cannot be used.
	When changing systems, all settings of functions and parameters are reset.	Settings which are still needed, and which must be configured anew, must be noted down in advance.
	It is not possible to access storage priority, as the selected system only has one storage tank.	The setting is not required with this system.
	In order to protect the pumps from mechanical seizure, all pumps are switched on briefly once a day.	–
	The holiday function is activated. Storage tank is being re-cooled by the system.	–
	System is conducting hygiene-flushing of the circulation pipe.	–
	"Stagnation reduction" is activated. System is operating at high temperature level.	–
	The solar circuit has stopped because the controller is conducting a priority test. This test checks whether, instead of the second-priority storage tank, the first-priority storage tank could also be loaded. This test can take several minutes, as the collector array must heat up sufficiently.	–
	Solar circuit is running due to interval test. The collector's heat transfer fluid is being transported to the sensor.	–

 Thermal frost protection is active	The solar circuit is running in order to protect the collector from icing up.	-
 Volume flow fault solar circuit: check hydraulics! Air in system?	Despite the fact that the pump is running, the temperature difference between the collector and the external heat exchanger is too great. -> Volume flow is too low.	Check the solar circuit's hydraulics, pump, valves, and shut-off devices. If necessary, bleed the system, open the shut-off devices, and flush out blockages.
 Volume flow fault secondary circuit: check hydraulics! Air in system?	Despite the fact that the pump is running, the temperature difference between the external heat exchanger and the storage tank is too great. -> Volume flow is too low.	Check the loading circuit's hydraulics, pump, valves, and shut-off devices. If necessary, bleed the system, open the shut-off devices, and flush out blockages.
 Collector connections may be wrong way round. Check hydraulics!	Solar circuit shows "suspicious" cycle behaviour.	Check the collector array's supply and return pipes, and mount them correctly if applicable.
 Info: double allocation / conflicting settings	The internal settings check has identified conflicting settings, or double allocation of sensors.	Check the function's time settings. Double allocation of sensors is permitted, and this is only intended as information.
 Plausibility check => user manual: P36	The internal plausibility check has identified conflicting settings.	Look up the error code in the operating instructions (chapter 11) and check/correct the entries.
 Fault detected in sensor or sensor cable	A sensor error has been detected.	Locate and check the corresponding sensor(s) in the display menu.
 Sensor cable interrupted or no sensor connected !	Sensor cable is interrupted, incorrectly connected, or the sensor is possibly defective.	Check connection and/or sensor cable. Possibly check sensor and sensor cable using an ohmmeter.
 Short circuit in sensor cable!	Sensor cable has short-circuited or the sensor is possibly defective.	Check connection and/or sensor cable. Possibly check sensor and sensor cable using an ohmmeter.
 Storage tank / pool deactivated due to season or storage priority	Loading of the storage tank was deactivated due to storage priority.	If this is not wanted, loading can be reactivated via storage priority.
 Pump operation not enabled at present	The collector is in a stagnant state, pump starts are blocked in order to prevent damage.	Wait until the collector has cooled sufficiently before setting these values.

11 Plausibility indices

The internal plausibility check ascertains whether conflicting settings have been detected in the controller. In this event, an information window displays an error code. The reasons which cause the information window to appear, along with each corresponding error code, are described in the following table. Check your settings at the controller, and correct them if necessary.

P 1	Maximum temperature storage tank 1 + switch-on temperature difference 1 > maximum collector temperature
P 5	Temperature differential control storage tank 1 < switch-off temperature difference 1
P 6	Temperature differential control storage tank 1 < switch-off temperature difference 2 (system with 2 collector arrays)
P 8	Temperature differential control storage tank 3 < switch-off temperature difference 3
P 9	Temperature differential control storage tank 1 + 5 K < switch-off temperature difference 1 (system with external heat exchanger)
P 10	Temperature differential control storage tank 1 + 5 K < switch-off temperature difference 2 (system with 2 collector arrays and external heat exchanger)
P 12	Target temperature control storage tank 1 < minimum collector temperature
P 13	Target temperature control storage tank 1 > maximum collector temperature
P 18	Target temperature control storage tank 1 + 5 K < minimum collector temperature (system with external heat exchanger)
P 19	Target temperature control storage tank 1 + 5 K > maximum collector temperature (system with external heat exchanger)
P 22	Target temperature control storage tank 1 < minimum temperature loading circuit 1
P 23	Target temperature control storage tank 1 > maximum temperature loading circuit 1
P 28	Switch-on temperature difference external heat exchanger + maximum temperature storage tank 1 > maximum temperature loading circuit 1
P 29	Switch-on temperature difference external heat exchanger + maximum temperature storage tank 2 > maximum temperature loading circuit 1
P 31	Temperature differential control storage tank 1 < switch-off temperature difference external heat exchanger
P 33	Quick charge "OFF" > target temperature control storage tank 1
P 34	Quick charge "ON" and RPM control "OFF"
P 35	Circulation "ON" and temperature control and pulse control
P 37	Holiday function target temperature ≥ maximum storage tank temperature

12 Legal guarantee

In accordance with German statutory regulations, there is a 2-year legal guarantee on this product for the customer.

The seller will remove all manufacturing and material faults that occur in the product during the guarantee period and affect the correct functioning of the product. Natural wear and tear does not constitute a malfunction. No legal guarantee can be offered if the fault can be attributed to third parties, unprofessional installation or commissioning, incorrect or negligent handling, improper transport, excessive loading, use of improper equipment, faulty construction work, unsuitable construction location or improper operation or use. Legal guarantee claims shall only be accepted if notification of the fault is provided immediately after it is discovered. Guarantee claims are to be directed to the seller.

The seller must be informed before guarantee claims are processed. For processing a guarantee claim an exact fault description and the invoice/delivery note must be provided.

The seller can choose to fulfil the legal guarantee either by repair or replacement. If the product can neither be repaired nor replaced, or if this does not occur within a suitable period in spite of the specification of an extension period in writing by the customer, the reduction in value caused by the fault shall be replaced, or, if this is not sufficient taking the interests of the end customer into consideration, the contract is cancelled.

Any further claims against the seller based on this legal guarantee obligation, in particular claims for damages due to lost profit, loss-of-use or indirect damages are excluded, unless liability is obligatory by law.

13 Technical data

Temperature difference controller	
Rated voltage (system voltage)	230 VAC, 50 Hz [optional 115 VAC, 60 Hz]
Max. own consumption	≤ 4 W
Inputs	4 T1 - T4: temperature recording (Pt1000)
Outputs	2 R1: TRIAC output for RPM control, max. switching current 1.1 A AC R2: relay switched output, max. switching current 3.47 AAC
Number of pre-defined hydraulic schemes	4
Ingress protection	IP 20/DIN 40050
Protection class	I
Permitted ambient temperature	0 to +45 °C
Display	Animated graphic LCD with backlighting
Dimensions L x W x H [mm]	170 x 170 x 46
Software class	A
Type of action	Type 1B
Type of fastening for permanently con- nected cables	Type X
Intended transport condition	No information
Degree of pollution	2
Ball pressure test temperature	850 °C
overvoltage category	Class II (2500 V)

13.1 Performance data

Output	Power	Fuse
R1	250 W (230 VAC)/125 W (115 VAC)	Internal fuse: 1.6 A T, 250 V or T 1.6 A H 250 V (Littelfuse: 21501.6)
R2	800 W (230 VAC)/400 W (115 VAC)	Internal fuse: 4 A T, 250 V or T 4 A H 250 V (Littelfuse: 215004)

DANGER

Risk of death by electrocution!

Fuses may only be changed after disconnection from the power supply, and by trained professional personnel!



13.2 Parameter settings

Maximum temperature storage tank 1 and storage tank 2:

Factory setting	Adjustable down to min.	Adjustable up to max.	Description
60 °C	0 °C	95 °C	When the maximum temperature of storage tank 1 (storage tank 2) is reached, storage tank 1 (storage tank 2) is not loaded until the temperature drops to 3 K below the defined maximum value.

Switch-on temperature difference solar 1 and solar 2:

Factory setting	Adjustable down to min.	Adjustable up to max.	Description
8 K	Switch-off temperature difference +2 K	50 K	When the switch-on temperature difference between collector and storage tank is reached, the storage tank is loaded.

Switch-off temperature difference solar 1 and solar 2:

Factory setting	Adjustable down to min.	Adjustable up to max.	Description
4 K	0 K	Switch-on temperature difference -2 K	When the switch-off temperature difference between collector and storage tank is reached, loading of the storage tank is stopped. The difference between the switch-on temperature difference and the switch-off temperature difference must be at least 2 K, and is barred from being set any lower.

Switch-on temperature difference external heat exchanger:

Factory setting	Adjustable down to min.	Adjustable up to max.	Description
6 K	-	-	When the switch-on temperature difference between the secondary side of the external heat exchanger and the storage tank is reached, the storage tank is loaded. This value cannot be changed.

Switch-off temperature difference external heat exchanger:

Factory setting	Adjustable down to min.	Adjustable up to max.	Description
3 K	-	-	When the switch-off temperature difference between the secondary side of the external heat exchanger and the storage tank is reached, loading of the storage tank is stopped. This value cannot be changed.

Maximum collector temperature:

Factory setting	Adjustable down to min.	Adjustable up to max.	Description
130 °C	Minimum collector temperature +20 K	180 °C	When the maximum collector temperature is reached, the solar circuit pump switches off. When the temperature drops to 3 K below the defined maximum value, the solar circuit pump switches on again.

Minimum collector temperature:

Factory setting	Adjustable down to min.	Adjustable up to max.	Description
0 °C	0 °C	Maximum collector temperature -20 K	Only when the minimum collector temperature is reached, and in consideration of the other switch-on conditions, does the solar circuit pump switch on. This value can be increased up to 20 K below the defined maximum collector temperature.

Switch-on temperature difference return increase:

Factory setting	Adjustable down to min.	Adjustable up to max.	Description
6 K	Switch-off temperature of return +2 K	50 K	When the switch-on temperature difference between storage tank temperature and heating return temperature is reached, the switching valve is activated and water flows through the storage tank.

Switch-off temperature difference return increase:

Factory setting	Adjustable down to min.	Adjustable up to max.	Description
3 K	0 K	Switch-on temperature of return -2 K	When the switch-off temperature difference between storage tank temperature and heating return temperature is reached, the switching valve returns to its initial state. The difference between the switch-on temperature difference and the switch-off temperature difference for return increase must be at least 2 K, and is barred from being set any lower.

Maximum temperature loading circuit:

Factory setting	Adjustable down to min.	Adjustable up to max.	Description
100 °C	Minimum loading circuit temperature +20 K	130 °C	When the temperature on the secondary side in the heat exchanger reaches 3 K below the defined maximum value, the solar circuit pump is switched off and the storage tank loading pump continues to run. When the temperature drops back down to 10 K below the maximum value, the solar pump switches on again. If the defined maximum value is nevertheless reached, the storage tank loading pump also switches off, for safety reasons. When the temperature returns to below the maximum temperature, the storage tank loading pump switches on again.

Minimum temperature loading circuit:

Factory setting	Adjustable down to min.	Adjustable up to max.	Description
0 °C	0 °C	Maximum temperature loading circuit -20 K	The storage tank loading pump is not switched on until the temperature on the secondary side of the heat exchanger has reached the defined minimum temperature.

Loading strategy storage tank 1

Factory setting	Adjustable down to min.	Adjustable up to max.	Description
Temperature differential control			It is possible to choose between temperature differential loading and target temperature loading. Depending on the selected loading strategy, the controller either attempts to comply with the defined temperature difference between collector and storage tank, or to reach the defined target temperature as quickly as possible. See chapter 7.3.2 for information regarding settings.
8 K	2 K	50 K	
Target temperature control			
60 °C	0 °C	95 °C	

RPM control pump R1:

Factory setting	Adjustable down to min.	Adjustable up to max.	Description
50 %	30 %	100 %	If RPM control is activated, the power at the controller's output R1 is regulated by means of full-wave packet control, according to the measured temperature values and controller settings. When RPM control is deactivated, full power is present at the controller's output R1. See chapter 7.3.3 for information regarding settings.

13.3 Parameter values for functions

Circulation:

Factory setting	Adjustable down to min.	Adjustable up to max.	Comment
Temperature controlled:			
Switch-on temperature:			
30 °C	0 °C	Switch-off temperature -2 K	
Switch-off temperature:			
35 °C	Switch-on temperature +2 K	95 °C	
Pulse controlled:			
Circulation time:			
2 min	1 min	10 min	
Wait time:			
10 min	0 min	60 min	

Back-up heating:

Factory setting	Adjustable down to min.	Adjustable up to max.	Comment
Temperature controlled:			
Switch-on temperature:			
55 °C	0 °C	Switch-off temperature -2 K	
Switch-off temperature:			
60 °C	Switch-on temperature +2 K	95 °C	

Solid fuel boiler:

Factory setting	Adjustable down to min.	Adjustable up to max.	Comment
Temperature controlled:			
Switch-on temperature difference:			
6 K	Switch-off temperature difference +2 K	20 K	
Switch-off temperature difference:			
3 K	0 K	Switch-on temperature difference -2 K	
Maximum heat target temperature:			
60 °C	0 °C	150 °C	
Minimum heat source temperature:			
50 °C	30 °C	95 °C	

Quick charge:

Factory setting	Adjustable down to min.	Adjustable up to max.	Comment
Temperature controlled:			
Switch-on temperature:			
50 °C	0 °C	95 °C	The switch-off temperature is adjusted according to the hysteresis.
Switch-off temperature:			
52 °C	Switch-on temperature +2 K	Switch-on temperature +10 K	

Heat quantity:

Factory setting	Adjustable down to min.	Adjustable up to max.	Comment
Glycol content:			
40 %	0 %	60 %	
Flow rate value for recording flow rate without a flow sensor:			
Flow rate value for maximum pump speed:			
--	0	99	The flow rate value for the maximum pump speed must be greater than the flow rate value for the minimum pump speed.
Flow rate value for minimum pump speed:			
--	0	99	The flow rate value for the maximum pump speed must be greater than the flow rate value for the minimum pump speed.

Thermostat:

Factory setting	Adjustable down to min.	Adjustable up to max.	Comment	
Temperature controlled:				
Switch-on temperature:				
20 °C	0 °C	180 °C	The on and off values can be set independently of each other.	
Switch-off temperature:				
20 °C	0 °C	180 °C		

Differential thermostat:

Factory setting	Adjustable down to min.	Adjustable up to max.	Comment
Temperature controlled:			
Switch-on temperature difference:			
6 K	Switch-off temperature difference +2 K	80 K	
Switch-off temperature difference:			
3 K	0 K	Switch-on temperature difference -2 K	
Maximum heat source temperature:			
100 °C	Minimum source temperature +2 K	180 °C	

Minimum heat source temperature:			
0 °C	0 °C	Maximum source temperature - 2 K	
Temperature limit heat target:			
60 °C	0 °C	95 °C	

Interval:

Factory setting	Adjustable down to min.	Adjustable up to max.	Comment
Interval time:			
15 min	10 min	60 min	
Test-on time:			
5 sec.	3 sec.	30 sec.	

Holiday function / recooling:

Factory setting	Adjustable down to min.	Adjustable up to max.	Comment
Minimum storage tank temperature:			
35 °C	0 °C	95 °C	If possible, the storage tank is cooled down to the defined minimum temperature at night.

14 Notes



728138